

USER MANUAL FOR  
**GENESYS™ 10KW/15KW**  
**Programmable DC Power Supplies**

Document: 83532002 Rev C



**TDK-Lambda Americas Inc.**

High Power Division



**TDK-Lambda Americas Inc.**  
405 Essex Road  
Neptune, NJ 07753 USA  
Telephone: +1 732.922.9300  
Facsimile: +1 732.922.9334  
Internet: www.us.tdk-lambda.com/hp

### DECLARATION OF CONFORMITY

#### Genesys™ 3U Power Supply Product Series with/without optional “1725” and “1900” suffixes

We TDK-Lambda Americas located in Neptune, NJ USA declare under our sole responsibility that the Genesys™ 3U Power Supply Product Series with/without optional “1725” and “1900” suffixes, as detailed on the attached products cover sheet, comply with the provisions of the following European Directives and are eligible to bear the CE mark:

Low Voltage Directive	2006/95/EC
EMC directive	2004/108/EC

Assurance of conformance of the described product with the provisions of the stated EC Directives is given through compliance to the following standards:

Electrical Safety:	IEC60950-1:2005, Second Edition / A1: 2009 EN 60950-1:2006 / A12:2011 UL60950-1:2007, Second Edition / A1: 2009
--------------------	---

Electromagnetic Emissions:	EN 61326-1:2013 EN 61204-3:2000
----------------------------	------------------------------------

These products are high-power equipment, with input power >1kW, for professional use and installation, and carry the CE mark accordingly. These products are for use in Class A, ITE environment only, as defined by EN 61326-1:2013 and EN 61204-3:2000.

Our European Representative in the EU is TDK-Lambda UK Limited, located at Kingsley Avenue, Ilfracombe, Devon, EX34 8ES UK. Further all products covered by this declaration are manufactured in accordance with ISO9001:2008 which ensure continued compliance of the products with the requirements of the Low Voltage and the EMC directives.

Name of Authorized Signatory	Martin Southam
Signature of Authorized Signatory	
Position of Authorized Signatory	Marketing Director, TDK-Lambda EMEA
Date	4 <sup>th</sup> June 2015
Date series first CE marked	4 <sup>th</sup> June 2015
Place where signed	Ilfracombe, Devon, England

## PRODUCTS COVERED SHEET

Product Series: Genesys™ 3U Power Supply Product Series with/without “-1725” and “-1900” suffixes.

Models:            GEN AAA-BBBB-KKK-Z  
                      GEN AAA-BBBB-KKK-Z-1725  
                      GEN AAA-BBBB-KKK-Z-1900  
                      GEN AAA-BBBB-CCC-KKK-Z-1900

Where:

“AAA”: is the Output Voltage range (30V to 600V).

“BBBB”: is the Output Current range (0 to 500A, depending on Output Voltage).

“CCC”: is the second Output Current range - from 0 to 125A (40V model only).

“KKK”: represents other options that do not affect Safety or EMC.

“Z”: represents the Three-Phase AC Input Voltage (208VAC, 400VAC or 480VAC).

“1725”, “1900” and other suffixes indicate different options that do not affect safety or EMC.



TDK-Lambda Americas Inc  
405 Essex Road  
Neptune NJ 07753 USA  
Tel: +1 732 922 9300  
Fax: +1 732 922 9334  
www.us.tdk-lambda.com/hp

## DECLARATION OF CONFORMITY GEN 3U AND QS SERIES

We, TDK-Lambda Americas Inc., of 405 Essex Road, Neptune, NJ 07753, USA declare under our sole responsibility that the GEN3U and QS series as detailed on the attached products covered sheet comply with the provisions of the following European Directives and are eligible to bear the CE mark:

Low Voltage Directive      2006/95/EC  
EMC Directive                2004/108/EC

Assurance of conformance of the described product with the provisions of the stated EC Directive is given through compliance to the following standards:

Electrical Safety            IEC60950-1:2005, Second Edition  
                                      EN60950-1:2006  
                                      UL60950-1:2007, Second Edition

Electromagnetic Emissions:    EN 61326:1997 + A1:1998 + A2:2001 + A3:2003 Annex E & F

These products are high-power equipment, with input power >1 kW, for professional use and installation, and carry the CE mark accordingly. These products are for use in Class A, ITE environment only, as defined by EN 61326: 1997+ A1:1998 + A2:2001 + A3:2003 Annex E & F.

Our European Representative in the EU is TDK-Lambda UK Limited, located at Kingsley Avenue, Ilfracombe, Devon, EX34 8ES UK. Further, all products covered by this declaration are manufactured in accordance with ISO9001:2000 which ensure continued compliance of the products with the requirements of the Low Voltage Directive.

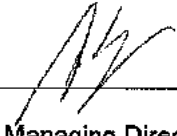
Name of Authorized Signatory	Adam Rawicz-Szczerbo
Signature of Authorized Signatory	
Position of Authorized Signatory	Managing Director, TDK-Lambda EMEA
Date	1 <sup>st</sup> Oct 08
Place where signed	Ilfracombe, Devon, England

## PRODUCTS COVERED SHEET FOR THE GEN3U AND QS SERIES

Product Name: GEN 3U Series Switch Mode DC Power Supply  
QS Series Switch Mode DC Power Supply

Models: GEN AAA-BBB-KKK-Z  
QS AAA-BBB-KKK-Z

A= Volts (7.5V to 600V)

B= Current (25A to 1000A depending on power not to exceed 15kW).

KKK = alphanumeric designation for options that do NOT affect EMC or Safety

Z= 3P208 for 208Vac 3 phase input or 3P400 for 400Vac 3 phase input.

Z may be followed by special numbers 1602, 1653, 1665, 1667, 1687, 1688, or 1690.

## Genesys™ Manual Supplement

For units equipped with the “**IEMD**” option,  
for IEEE-488 with Multi-drop,  
also refer to IEMD manual 83030200

For units equipped with the “**LAN**” option  
for Local Area Network with Multi-drop,  
also refer to LAN manual 83034100

# Table of Contents

<b>WARRANTY</b> .....	<b>4</b>
<b>SAFETY INSTRUCTIONS</b> .....	<b>5</b>
<b>1. GENERAL INFORMATION</b> .....	<b>23</b>
1.1. User Manual Content.....	23
1.2. Introduction.....	23
1.3. Accessories .....	25
1.4. Model Number Format.....	26
<b>2. SPECIFICATIONS</b> .....	<b>27</b>
2.1. Output Rating (Duty Cycle Continuous Duty).....	27
2.2. Input Characteristics.....	27
2.3. Static Characteristics.....	27
2.4. Protective Functions.....	28
2.5. Dynamic Characteristics.....	28
2.6. Remote Analog Control And Signals.....	29
2.7. Front Panel.....	30
2.8. Software Spec. ....	30
2.9. Digital Programming And Readback .....	31
2.10. Mechanical Construction .....	31
2.11. Environmental Conditions.....	31
2.12. EMC.....	32
2.13. Safety .....	32
2.14. J1 Connector .....	33
<b>3. INSTALLATION</b> .....	<b>34</b>
3.1. General.....	34
3.2. Preparation for Use .....	34
3.3. Initial Inspections.....	34
3.4. Rack Mounting.....	35
3.5. Location, Mounting and Cooling.....	35
3.6. AC Source Requirements.....	35
3.7. AC Input Power Connection .....	35
3.8. Turn-On Checkout Procedure .....	37
3.9. Connecting the Load .....	39
3.10. Local and Remote Sensing .....	43
3.11. Repackaging for Shipment.....	45
<b>4. FRONT AND REAR PANEL CONTROLS AND CONNECTORS</b> .....	<b>46</b>
4.1. Introduction.....	46
4.2. Front Panel Controls and Indicators.....	46
4.3. Rear Panel Connections and Controls .....	48
4.4. Rear Panel SW1 Setup Switch.....	51
4.5. Rear Panel J1 Programming and Monitoring Connector.....	52

<b>5. LOCAL OPERATION.....</b>	<b>54</b>
5.1. Introduction.....	54
5.2. Standard Operation .....	54
5.3. Over Voltage Protection (OVP) .....	55
5.4. Under Voltage Limit (UVL).....	56
5.5. Foldback Protection.....	56
5.6. Output ON/OFF Control.....	57
5.7. Output SHUT-OFF (SO) Control via Rear Panel J1 Connector .....	57
5.8. Enable/Disable Control via Rear Panel J1 Connector.....	58
5.9. CV/CC Signal .....	58
5.10. PS_OK Signal.....	58
5.11. Safe Start and Auto-Restart Modes .....	59
5.12. Front Panel Locking.....	59
5.13. Over Temperature Protection (OTP) .....	60
5.14. Last Setting Memory.....	60
<b>6. SERIES AND PARALLEL OPERATION .....</b>	<b>61</b>
6.1. Series Operation.....	61
6.2. Parallel Operation (Single-Wire/Two-Wire Method) .....	64
<b>7. REMOTE AND ANALOG PROGRAMMING.....</b>	<b>72</b>
7.1. Introduction.....	72
7.2. Local/Remote Analog Selection .....	72
7.3. Local/Remote Analog Indication.....	73
7.4. Remote Voltage Programming of Output Voltage and Current Limit .....	73
7.5. Resistive Programming of Output Voltage and Current Limit .....	75
7.6. Remote Monitoring of Output Voltage and Current.....	76
<b>8. RS-232 &amp; RS-485 REMOTE CONTROL .....</b>	<b>77</b>
8.1. Introduction.....	77
8.2. Configuration .....	77
8.3. Rear Panel RS-232/RS-485 Connector .....	78
8.4. Connecting Power Supplies to the RS-232 or RS-485 Bus .....	79
8.5. Communication Interface Protocol .....	80
8.6. Error Messages .....	81
8.7. Command Set Description.....	82
8.8. Global Output Commands .....	85
8.9. Fast Queries .....	88
8.10. Status and Error Commands.....	89
8.11. Status, Error, and SRQ Registers .....	90
8.12. Serial Communication Test Set-Up .....	93



**9. ISOLATED ANALOG PROGRAMMING OPTION..... 95**

- 9.1. Introduction..... 95
- 9.2. Specifications ..... 95
- 9.3. Isolated Programming & Monitoring Connector ..... 96
- 9.4. Setup and Operating Instructions..... 97

**10.MAINTENANCE..... 98**

- 10.1. Introduction..... 98
- 10.2. Units Under Warranty ..... 98
- 10.3. Periodic Maintenance ..... 98
- 10.4. Adjustments and Calibration..... 98
- 10.5. Parts Replacement and Repairs..... 98
- 10.6. Troubleshooting..... 98

---

## **WARRANTY**

This TDK-Lambda Americas Inc. product is warranted against defects in materials and workmanship for a period of five years from date of shipment. During the warranty period, TDK-Lambda Americas Inc. will, at it's option, either repair or replace products which prove to be defective.

## **LIMITATION OF WARRANTY**

The warranty shall not apply to defects resulting from improper or inadequate usage or maintenance by the buyer, buyer supplied products or interfacing. The warranty shall not apply to defects resulting from unauthorized modifications, or from operation exceeding the environmental specifications of the product, or if the QA seal has been removed or altered by anyone other than TDK-Lambda Americas Inc. authorized personnel. TDK-Lambda Americas Inc. does not warrant the buyer's circuitry or malfunctions of TDK-Lambda Americas Inc. products resulting from the buyer's circuitry. Furthermore, TDK-Lambda Americas Inc. does not warrant any damage occurring as a result of the buyer's circuitry or the buyer's - supplied products. THIS LIMITED WARRANTY IS IN LIEU OF, AND TDK-LAMBDA AMERICAS INC DISCLAIMS AND EXCLUDES, ALL OTHER WARRANTIES, STATUTORY, EXPRESS OR IMPLIED, INCLUDING, WITHOUT LIMITATION, ANY WARRANTY OF MERCHANTABILITY OR FITNESS FOR A PARTICULAR PURPOSE, OR OF CONFORMITY TO MODELS OR SAMPLES.

## **WARRANTY SERVICE**

This product must be returned to an authorized TDK-Lambda Americas Inc. service facility for repairs or other warranty service. For products returned to TDK-Lambda Americas Inc. for warranty service, the buyer shall prepay shipping charges to TDK-Lambda Americas Inc. If the unit is covered under the foregoing warranty then TDK-Lambda Americas Inc. shall pay the shipping charges to return the product to the buyer. Refer to Section 3.11 for repackaging for shipment.

## **DISCLAIMER**

The information contained in this document is subject to change without notice. TDK-Lambda Americas Inc. shall not be liable for errors contained in this document or for incidental or consequential damages in connection with the furnishing, performance or use of this material. No part of this document may be photocopied, reproduced or translated into another language without the prior written consent of TDK-Lambda Americas Inc.

## **TRADEMARK INFORMATION**

Genesys™ power supply is a trademark of TDK-Lambda Americas Inc.  
Microsoft™ and Windows™ are trademarks of Microsoft Corporation.

## **THE FCC WANTS YOU TO KNOW**

This equipment has been tested and found to comply with the limits for a Class A digital device, pursuant to Part 15 of the FCC rules. These limits are designed to provide reasonable protection against harmful interference when the equipment is operated in a commercial environment.

This equipment generates, uses and can radiate radio frequency energy and, if not installed and used in accordance with the instructions, may cause harmful interference to radio communications.

Operation of this equipment in a residential area is likely to cause harmful interference, in which case the user will be required to correct the interference at his own expense.

## **FCC WARNING**

Modifications not expressly approved by manufacturer could void the user authority to operate the equipment under FCC Rules.

## ENGLISH

### SAFETY INSTRUCTIONS

#### CAUTION

The following safety precaution must be observed during all phases of operation, service and repair of this equipment. Failure to comply with the safety precautions or warnings in this document violates safety standards of design, manufacture and intended use of this equipment and may impair the built-in protections within.

TDK-Lambda Americas Inc. shall not be liable for user's failure to comply with these requirements.

#### INSTALLATION CATEGORY

The Genesys™ power supply series has been evaluated to INSTALLATION CATEGORY II. Installation category (over voltage category) II: local level, appliances, portable equipment etc. With smaller transient over voltage than Installation Category (over voltage category) III.

#### GROUNDING

This product is a Safety Class 1 instrument. To minimize shock hazard, the instrument chassis must be connected to an electrical ground. The instrument must be connected to the AC power supply mains through a three conductor power cable, with the ground wire firmly connected to an electrical ground (safety ground) at the power outlet.

For instruments designed to be hard-wired to the supply mains, the protective earth terminal must be connected to the safety electrical ground before another connection is made. Any interruption of the protective ground conductor or disconnection of the protective earth terminal will cause a potential shock hazard that might cause personal injury.

<b>WARNING</b>	
<b>OUTPUT TERMINALS GROUNDING</b>	
	There is a potential shock hazard at the RS-232/RS-485, LAN and the IEEE ports when using power supplies with rated or combined voltage greater than 400V and the Positive Output of the Power Supply is grounded.
	<b><i>Do Not</i></b> connect the Positive Output to ground when using the RS-232/RS-485, LAN or IEEE.

#### FUSES

Fuses must be changed by authorized TDK-Lambda Americas Inc. service personnel only. For continued protection against risk of fire, replace only with the same type and rating of fuse.

#### INPUT RATINGS

Do not use AC supply, which exceeds the input voltage and frequency rating of this instrument. The input voltage and frequency rating of the Genesys™ power supply series has three input ranges depending on the model type ordered. Ranges are 180-253VAC/342-440VAC/432-528VAC, 50-60Hz. For safety reasons, the mains supply voltage fluctuations should not exceed above voltage range.

#### LIVE CIRCUITS

Operating personnel must not remove the instrument cover. No internal adjustment or component replacement is allowed by non-TDK-Lambda Americas Inc. qualified personnel. Never replace components with power cable connected. To avoid injuries, always disconnect power, discharge circuits and remove external voltage source before touching components.

## PARTS SUBSTITUTIONS & MODIFICATIONS

Parts substitutions and modifications are allowed by authorized TDK-Lambda Americas Inc. service personnel only. For repairs or modifications, the instrument must be returned to an authorized TDK-Lambda Americas Inc. Service facility.









## SAFETY INSTRUCTIONS

### ENVIRONMENTAL CONDITIONS

The Genesys™ Power Supply series safety approval applies to the following operating conditions:

- \*Indoor use
- \*Maximum relative humidity: 80% (no condensation)
- \*Pollution degree 2
- \*Ambient temperature: 0°C to 50°C
- \*Altitude: up to 3000m

**CAUTION** Do not use this product in environments with strong Electromagnetic field, corrosive gas and conductive materials.

	ATTENTION Observe Precautions for handling Electrostatic Sensitive Devices.
	CAUTION Risk of Electrical Shock
	Instruction manual symbol. The instrument will be marked with this symbol when it is necessary for the user to refer to the instruction manual.
	Indicates hazardous voltage.
	Indicates ground terminal.
	Protective Ground Conductor Terminal must be connected to Earth Ground.
	Off (Supply)
	On (Supply)
<b>WARNING</b>	The WARNING sign denotes a hazard. An attention to a procedure is called. Not following procedure correctly could result in personal injury. A WARNING sign should not be skipped and all indicated conditions must be fully understood and met.
<b>CAUTION</b>	The CAUTION sign denotes a hazard. An attention to a procedure is called. Not following procedure correctly could result in damage to the equipment. Do not proceed beyond a CAUTION sign until all indicated conditions are fully understood and met.

**FCC COMPLIANCE NOTICE:**

Note: This equipment has been tested and found to comply with the limits for a Class A digital device, pursuant to part 15 of the FCC Rules. These limits are designed to provide reasonable protection against harmful interference when the equipment is operated in a commercial environment. This equipment generates uses, and can radiate radio frequency energy and, if not installed and used in accordance with the instruction manual, may cause harmful interference to radio communications. Operation of this equipment in a residential area is likely to cause harmful interference in which case the user will be required to correct the interference at his own expense.

## FRENCH

### CONSIGNES DE SECURITE

#### ATTENTION

Les consignes de sécurité suivantes doivent être observées pendant toutes les phases de l'utilisation, entretien et réparations de cet équipement. Le non-respect des consignes de sécurité et des avertissements dans ce document viole les normes sécurité de conception, fabrication et utilisation prévue de cet équipement et peut compromettre les protections incorporées en lui.

TDK-Lambda Americas Inc. ne sera pas responsable des conséquences si l'utilisateur ne respecte pas ces consignes.

#### CATEGORIE D'INSTALLATION

Les alimentations Genesys™ ont été classées dans CATEGORIE INSTALLATION II. Catégorie installation (catégorie surtension) II : utilisation locale, appareils, équipement portable, etc. Avec des surtensions transitoires plus faibles que celles de la catégorie installation (catégorie surtension) III.

#### MISE A LA TERRE

Ce produit est un instrument Classe 1 Sécurité. Pour minimiser le risque de choc électrique, son châssis doit être raccordé à une terre électrique. L'instrument doit être raccordé à l'alimentation principale AC par un câble à trois conducteurs, le conducteur de terre étant raccordé à une terre électrique (terre sécurité) sur la prise électrique.

Pour les instruments conçus pour être raccordés à l'alimentation électrique principale, la borne de terre doit être raccordée à la terre électrique de sécurité avant d'établir une autre connexion. Si le conducteur de terre est coupé ou si la borne de terre est débranchée, il y a un risque de choc électrique pouvant provoquer des blessures.

#### ATTENTION-DANGER

##### MISE A LA TERRE DES BORNES DE SORTIE



Il y a un danger de choc électrique sur les ports RS-232/RS-485, LAN et IEEE lorsqu'on utilise des alimentations électriques ayant à elles seules ou au total une tension supérieure à 400V et si la sortie positive de l'alimentation est raccordée à la terre.

**Ne** raccordez **pas** la sortie positive à la terre si vous utilisez les ports RS-232/RS-485, LAN ou IEEE.

#### FUSIBLES

Les fusibles ne doivent être remplacés que par des techniciens d'entretien agréés TDK-Lambda Americas Inc. Pour assurer une protection continue contre le risque d'incendie, remplacez les fusibles par des fusibles de même type et de même capacité.

#### ALIMENTATION PRINCIPALE

N'utilisez pas une alimentation AC dont la tension et la fréquence dépassent les valeurs nominales de cet instrument. La tension et la fréquence nominales des alimentations Genesys™ correspondent à trois intervalles selon le modèle commandé. Les intervalles sont 180-253VAC/342-440VAC/432-528VAC, 50-60Hz. Pour des raisons de sécurité, la tension d'alimentation principale ne doit pas fluctuer en dehors des intervalles ci-dessus.

#### CIRCUITS SOUS TENSION

Le personnel d'exploitation ne doit pas enlever le couvercle de l'instrument. Le réglage ou le remplacement des composants internes ne peut être effectué que par un personnel qualifié TDK-Lambda Americas Inc. Ne remplacez jamais les composants lorsque le câble d'alimentation est connecté. Pour éviter les blessures, débranchez toujours l'alimentation, déchargez les circuits et retirez la source de tension extérieure avant de toucher les composants.

## CONSIGNES DE SECURITE

### SUBSTITUTIONS ET MODIFICATIONS DE PIECES

Les substitutions et modifications de pièces ne peuvent être effectuées que par les techniciens d'entretien agréés TDK-Lambda Americas Inc. Pour les réparations ou les modifications, l'instrument doit être renvoyé à un centre d'entretien agréé TDK-Lambda Americas Inc.

### CONDITIONS ENVIRONNEMENTALES

L'approbation sécurité des alimentations Genesys™ s'applique aux conditions opératoires suivantes :











\*Utilisation en intérieur

\*Température ambiante : 0°C à 50°C

\*Humidité relative maximum : 80% (sans condensation)

\*Altitude : 3000m maximum

\*Pollution degré 2

	PRECAUTION. Observez les précautions pour manipuler les composants sensibles à l'électricité statique.
	ATTENTION. Risque de choc électrique
	Symbole dans le manuel d'instructions. Ce symbole sera marqué sur l'instrument lorsque l'utilisateur doit consulter le manuel d'instructions.
	Signale une tension dangereuse.
	Signale une borne de terre.
	La borne du conducteur de terre de protection doit être connectée à la terre électrique.
	Coupée (alimentation)
	Branchée (alimentation)
	Le symbole WARNING signale un danger. Il attire l'attention sur une procédure. Si la procédure n'est pas suivie correctement, il peut en résulter des blessures. Le symbole WARNING (Attention-danger) ne doit pas être ignoré et toutes les conditions indiquées doivent être bien comprises et respectées.
	Le symbole CAUTION (Attention) signale un danger. Il attire l'attention sur une procédure. Si la procédure n'est pas suivie correctement, l'équipement peut être endommagé. Ne continuez pas après avoir rencontré le symbole CAUTION tant que vous n'avez pas parfaitement compris et respecté les conditions indiquées.

**NOTE CONCERNANT LA CONFORMITE FCC :**

Nota : Cet équipement a été testé et s'est avéré conforme aux limites pour un appareil numérique Classe A selon la part 15 des règles FCC. Ces limites sont conçues pour assurer une protection raisonnable contre les interférences dangereuses lorsque l'équipement est utilisé dans un environnement commercial. Cet équipement génère, utilise et peut rayonner des fréquences radio et, s'il n'est pas installé et utilisé conformément au manuel d'instructions, il peut provoquer des interférences dangereuses pour les communications radio. L'utilisation de cet équipement dans une zone résidentielle provoquera probablement des interférences nocives, et dans ce cas l'utilisateur doit prendre des mesures pour les supprimer à ses propres frais.



## GERMAN

### SICHERHEITSVORSCHRIFTEN

#### VORSICHT

Die folgenden Sicherheitsvorschriften müssen in allen Phasen des Betriebs, der Wartung und der Reparatur der Anlage eingehalten werden. Eine Missachtung der Sicherheitsvorschriften und Warnhinweise aus diesem Handbuch führt zur Verletzung der bestehenden Sicherheitsstandards für Design, Produktion und der zweckbestimmten Verwendung der Anlage und kann die integrierten Schutzvorrichtungen beschädigen.

TDK-Lambda Americas Inc. ist nicht haftbar für Schäden, die durch Missachtung dieser Sicherheitsvorschriften entstehen können.

#### INSTALLATIONSKATEGORIE

Die Genesys™ Reihe der Netzgeräte wurde in die INSTALLATIONSKATEGORIE II eingeteilt. Installationskategorie (Überspannungskategorie) II: die lokale Ebene, Geräte, tragbare Anlagen, etc. mit kleineren vorübergehenden Überspannungen als die Installationskategorie (Überspannungskategorie) III.

#### ERDUNGSKONZEPT

Dieses Produkt ist ein Gerät der Schutzklasse 1. Zur Vermeidung von gefährlichen Energieinhalten und Spannungen, ist das Gehäuse des Gerätes an eine Schutzerde anzuschließen. Das Gerät muss über ein Dreileiterstromkabel an die AC-Hauptstromversorgung angeschlossen werden, wobei das Erdungskabel fest mit einer elektrischen Erdung (Schutzerde PE) am Stromanschluss verbunden sein muss.

Bei Festverdrahtung der Geräte ist sicherzustellen, dass der PE-Anschluss an die elektrische Schutzerde angeklemt wird, bevor das Gerät an die Stromversorgung angeschlossen wird. Jede Unterbrechung des PE-Leiters oder die Trennung der PE-Verbindung kann einen möglichen elektrischen Schlag hervorrufen, der Personenschäden zur Folge haben kann.

#### WARNUNG

##### ERDUNG DER AUSGANGSANSCHLÜSSE



Es besteht die Gefahr von möglichen Schlägen an der RS-232/RS-485, LAN und den IEEE-Anschlüssen, wenn Netzgeräte mit höheren Nenn- oder kombinierten Spannungen als 400V verwendet werden und die positive Ausgangsspannung der Netzgeräte geerdet wurde.

Klemmen Sie die positive Ausgangsspannung **nicht** an die Schutzerde an, wenn Sie RS-232/RS-485, LAN oder IEEE verwenden.

#### SICHERUNGEN

Sicherungen dürfen nur durch von TDK-Lambda Americas Inc. zugelassenes Personal ausgewechselt werden. Für anhaltenden Brandschutz dürfen die Sicherungen nur mit baugleichen Sicherungen mit der gleichen Leistung ersetzt werden.

## SICHERHEITSVORSCHRIFTEN

### EINGANGSLEISTUNG

Verwenden Sie keine AC-Spannung, die die Eingangsleistung und Frequenzrate dieses Gerätes übersteigt. Die Eingangsspannung und Frequenzrate der Genesys™ Reihe der Netzgeräte verfügt über drei Eingangsbereiche, je nach bestelltem Bautyp. Die Bereiche sind 180-253VAC/342-440VAC/432-528VAC, 50-60Hz. Aus Sicherheitsgründen sollten die Spannungsschwankungen der Hauptstromversorgung den oberen Spannungsbereich nicht übersteigen.

### SPANNUNGSFÜHRENDE TEILE

Die Geräteabdeckung darf nicht durch Betriebspersonal entfernt werden. Interne Modifikationen sowie Bauteilaustausch sind nur durch von TDK-Lambda Americas Inc. qualifiziertes Personal erlaubt. Vor dem Austausch von Komponenten muss immer die Versorgungsspannung getrennt werden. Um Personenschäden zu vermeiden, muss vor dem Kontakt mit dem Gerät immer die Stromversorgung unterbrochen, die Stromkreise entladen und externe Spannungsquellen entfernt werden.

### ERSATZTEILE & MODIFIKATIONEN

Ersatzteile und Modifikationen dürfen nur durch von TDK-Lambda Americas Inc. zugelassenes Personal durchgeführt werden. Für Reparaturen oder Modifikationen muss das Gerät an einen autorisierten TDK-Lambda Americas Inc. Vertriebspartner geschickt werden.

### UMGEBUNGSBEDINGUNGEN









Die Sicherheitsbestätigung der Genesys™ Netzteilserie gilt für die folgenden Betriebszustände:

\* Gebrauch im Innenbereich

\*Umgebungstemperatur: 0°C bis 50°C

\*Maximale relative Luftfeuchtigkeit: 80% (keine Kondensation) \*Höhe: bis zu 3.000m

\* Verschmutzungsgrad 2

	ACHTUNG Beachten Sie die Vorsichtsmaßnahmen im Umgang mit elektrostatisch gefährdeten Bauteilen.
	VORSICHT Gefahr von elektrischen Schlägen.
	Symbol der Bedienungsanleitung. Dieses Symbol wird am Gerät angezeigt, wenn der Benutzer die Bedienungsanleitung lesen soll.
	Weist auf eine gefährliche Spannung hin.
	Weist auf eine Erdungsklemme hin.
	PE-Leiterklemme must an Erde angeschlossen werden.
	Aus (Versorgung)
	Ein (Versorgung)
	Das WARNSYMBOL deutet auf eine Gefahr hin. Die Aufmerksamkeit wird auf ein Verfahren gelenkt. Eine Missachtung der Einhaltung des Verfahrens kann zu Personenschaden führen. Eine WARNUNG darf nicht übergangen werden und alle angezeigten Umstände müssen vollkommen verstanden und eingehalten werden.

## SICHERHEITSVORSCHRIFTEN

<b>CAUTION</b>	Das VORSICHTSYMBOL deutet auf eine Gefahr hin. Die Aufmerksamkeit wird auf ein Verfahren gelenkt. Eine Missachtung der korrekten Einhaltung des Verfahrens kann zu Materialschaden führen. Ein VORSICHTSYMBOL darf nicht übergangen werden bis alle angezeigten Umstände vollkommen verstanden und eingehalten werden.
	<b>FCC EINHALTUNGSVERMERK:</b> Hinweis: Das Gerät wurde geprüft und erfüllt die Grenzwerte für ein digitales Gerät der Klasse A gemäß Teil 15 der FCC-Regeln. Diese Grenzwerte wurden definiert, um angemessenen Schutz vor gefährlichen Störungen zu bieten, wenn das Gerät im kommerziellen Umfeld betrieben wird. Dieses Gerät kann Funkfrequenzenergie erzeugen, verwenden und ausstrahlen und kann, sofern es nicht gemäß dem Benutzungshandbuch installiert wurde, gefährliche Störungen im Funkverkehr verursachen. Es ist wahrscheinlich, dass dieses Gerät in Wohngebieten zu schädlichen Störungen führt, die in solchen Fällen auf Kosten des Benutzers behoben werden müssen.

## ITALIAN

### NORME DI SICUREZZA

#### ATTENZIONE

La seguente precauzione di sicurezza deve essere osservata a tutti gli stadi del funzionamento, della manutenzione e della riparazione di questa apparecchiatura. L'inosservanza delle precauzioni o delle avvertenze di sicurezza contenute in questo documento viola gli standard di sicurezza della progettazione, della produzione e dell'uso previsto di questa apparecchiatura, e può compromettere i dispositivi di protezione in essa incorporati.

TDK-Lambda Americas Inc. non si assume alcuna responsabilità per il mancato rispetto di questi requisiti da parte dell'utente.

#### CATEGORIA DI INSTALLAZIONE

La serie di alimentatori Genesys™ è stata valutata e risulta conforme alla CATEGORIA DI INSTALLAZIONE II. Categoria di installazione (categoria di sovratensione) II: livello locale, elettrodomestici, apparecchiature portatili ecc. Con sovratensioni transitorie inferiori alla Categoria di installazione (categoria di sovratensione) III.

#### MESSA A TERRA

Questo prodotto è uno strumento di Classe di sicurezza 1. Per minimizzare il pericolo di scosse elettriche, il telaio dello strumento deve essere collegato a una terra elettrica. Lo strumento deve essere collegato alla rete di alimentazione a CA mediante un cavo a tre conduttori, con il filo di terra ben collegato a una terra elettrica (terra di sicurezza) in corrispondenza della presa di corrente.

Per strumenti progettati per il cablaggio alla rete di alimentazione, il terminale protettivo di terra va collegato alla terra elettrica di sicurezza prima di procedere ad altri collegamenti. Eventuali interruzioni del conduttore protettivo di terra, o scollegamenti del terminale protettivo di terra, porteranno al rischio di scossa elettrica e di conseguente potenziale infortunio.

#### AVVERTENZA

##### MESSA A TERRA DEI TERMINALI DI USCITA



Vi è rischio di scossa elettrica in corrispondenza delle porte R-S232/RS-485, LAN e IEEE se si utilizzano alimentatori con tensione nominale o combinata oltre 400V e con l'Uscita positiva dell'alimentatore messa a terra.

**Non** collegare alla terra l'Uscita positiva quando si usano le porte RS-232/RS-485, LAN o IEEE.

#### FUSIBILI

I fusibili devono essere sostituiti unicamente da addetti autorizzati di TDK-Lambda Americas Inc. Per una protezione continua dal rischio di incendi, sostituire sono con fusibili di tipo e di potenza nominale identici.

#### POTENZE NOMINALI IN INGRESSO

Non usare un'alimentazione a CA che superi la tensione in ingresso e la potenza nominale di frequenza di questo strumento. La tensione in ingresso e la potenza nominale di frequenza della serie di alimentatori Genesys™ presentano tre bande di ingressi, a seconda del tipo di modello ordinato. Le bande sono: 180-253VAC/342-440VAC/432-528VAC, 50-60Hz. Per ragioni di sicurezza, eventuali fluttuazioni nella tensione di rete non devono superare il campo di potenze nominali suddetto.

#### CIRCUITI SOTTO TENSIONE

Nessun addetto deve mai rimuovere il coperchio dello strumento. Le regolazioni interne e la sostituzione dei componenti sono consentite unicamente al personale qualificato di TDK-Lambda Americas Inc. Non sostituire mai un componente con il cavo elettrico ancora collegato. A

prevenzione degli infortuni, staccare sempre la corrente, scaricare i circuiti e scollegare le fonti di tensione esterne prima di toccare i componenti.

## NORME DI SICUREZZA

### SOSTITUZIONI E MODIFICHE DEI COMPONENTI

I componenti devono essere sostituiti o modificati unicamente da addetti autorizzati di TDK-Lambda Americas Inc. Per riparazioni o modifiche, restituire lo strumento al centro assistenza di TDK-Lambda Americas Inc.

### CONDIZIONI AMBIENTALI

L'approvazione della sicurezza della serie di alimentatori Genesys™ è valida in presenza delle condizioni d'uso seguenti:











\*Usò in interni

\*Temperatura ambiente: 0°C - 50°C

\*Umidità relativa massima: 80% (zero condensa)

\*Altitudine: fino a 3000m

\*Inquinamento grado 2

	ATTENZIONE Osservare le precauzioni su come maneggiare i dispositivi sensibili alle scariche elettrostatiche.
	ATTENZIONE Rischio di scossa elettrica
	Simbolo del manuale delle istruzioni. Lo strumento sarà contrassegnato da questo simbolo ovunque l'utente deve fare riferimento al manuale delle istruzioni.
	Indica tensioni pericolose.
	Indica il terminale di terra.
	Il terminale del conduttore protettivo di terra deve essere collegato alla messa a terra.
	Spento (Alimentazione)
	Acceso (Alimentazione)
	Il simbolo di AVVERTIMENTO denota un periodo. È necessario prestare attenzione alla procedura. Il mancato rispetto della procedura può sfociare in un infortunio. Non ignorare alcun simbolo di AVVERTIMENTO. Tutte le condizioni indicate devono essere pienamente comprese e rispettate.
	Il simbolo di ATTENZIONE denota un pericolo. È necessario prestare attenzione alla procedura. Il mancato rispetto della procedura può sfociare in danni per l'apparecchiatura. Non procedere oltre un simbolo di ATTENZIONE senza prima avere pienamente compreso e rispettato tutte le condizioni indicate.

## NORME DI SICUREZZA

### **AVVISO DI CONFORMITÀ FCC:**

NB: Questa apparecchiatura è stata testata ed è risultata conforme ai limiti per i dispositivi digitali di Classe A, ai sensi della parte 15 dei Regolamenti FCC. Tali limiti sono formulati per offrire ragionevole protezione dalle interferenze pericolose quando l'apparecchiatura viene azionata in ambienti commerciali. Questa apparecchiatura genera, usa e può irradiare energia a radiofrequenza; se non viene installata ed utilizzata attenendosi al manuale delle istruzioni, può causare interferenze pericolose per le radiocomunicazioni. È probabile che l'uso di questa apparecchiatura in zone residenziali provochi interferenze pericolose. In tal caso, l'utente dovrà rettificare a proprie spese tali interferenze.

## PORTUGUESE

### INSTRUÇÕES DE SEGURANÇA

#### CUIDADO

As seguintes precauções de segurança devem ser respeitadas em todas as fases de funcionamento, assistência e reparação deste equipamento. A não observância dos avisos e precauções de segurança constantes neste documento viola os padrões de segurança da concepção, fabrico e utilização pretendida deste equipamento, podendo danificar as protecções integradas no seu interior.

A TDK-Lambda Americas Inc. não poderá ser responsabilizada pelo não cumprimento destes requisitos por parte do utilizador.

#### CATEGORIA DA INSTALAÇÃO

A série Genesys™ de fontes de alimentação foi avaliada como sendo uma INSTALAÇÃO DA CATEGORIA II. Categoria da instalação (categoria de sobretensão) II: nível local, instrumentos, equipamento portátil, etc. Com uma sobretensão transitória provisória inferior à das instalações da categoria (categoria de sobretensão) III.

#### LIGAÇÃO À TERRA

Este produto é um instrumento de Classe de Segurança 1. Para reduzir o risco de choque, o chassis do instrumento deve ter ligação de terra. O instrumento deve ser ligado à fonte de alimentação de corrente alternada através de um cabo de alimentação de três condutores, com o fio de terra firmemente ligado a uma ligação de terra (sistemas de segurança por ligação à terra) na tomada de alimentação.

Em instrumentos concebidos para serem ligados à fonte de alimentação através de cabos, o terminal de terra de protecção deve ser ligado ao sistema eléctrico de segurança por ligação à terra antes de se realizar qualquer outra ligação. Qualquer interrupção do condutor de terra de protecção ou corte do terminal de terra de protecção poderá originar um risco de choque passível de provocar ferimentos.

#### AVISO

##### LIGAÇÃO À TERRA DE TERMINAIS DE SAÍDA



Há a possibilidade de existir risco de choque nas portas RS-232/RS-485, LAN e IEEE quando se utilizam fontes de alimentação com tensão nominal ou combinada superior a 400V e a saída positiva da fonte de alimentação está ligada à terra. Não ligue a saída positiva à terra quando utilizar as portas RS-232/RS-485, LAN ou IEEE.

#### FUSÍVEIS

Os fusíveis apenas devem ser substituídos por pessoal de assistência autorizado da TDK-Lambda Americas Inc. Para obter uma protecção contínua contra o risco de incêndios, substitua sempre os fusíveis por outros do mesmo tipo e classificação.

#### CLASSIFICAÇÃO DAS ENTRADAS

Não utilize fontes de alimentação de corrente alternada que excedam a tensão de entrada e a classificação de frequência deste instrumento. A tensão de entrada e a classificação de frequência das fontes de alimentação da série Genesys™ têm três gamas de entrada, de acordo com o tipo de modelo encomendado. As gamas são: 180-253VAC/342-440VAC/432-528VAC, 50-60Hz. Por motivos de segurança, as flutuações da tensão da fonte de alimentação não devem exceder a gama da tensão superior.

# INSTRUÇÕES DE SEGURANÇA

## CIRCUITOS SOB TENSÃO

Os operadores não devem retirar a cobertura do instrumento. A realização de ajustes internos ou substituições de componentes só é permitida se realizada por pessoal especializado da TDK-Lambda Americas Inc. Nunca substitua componentes com o cabo de alimentação ligado. Para evitar ferimentos, desligue sempre a energia, descarregue os circuitos e desligue a fonte de tensão externa antes de tocar nos componentes.

## MODIFICAÇÕES E SUBSTITUIÇÕES DE PEÇAS

As modificações e substituições de peças apenas são permitidas quando realizadas pelo pessoal de assistência da TDK-Lambda Americas Inc. Para a realização de reparações ou modificações, é necessário devolver o instrumento a uma unidade de serviço autorizada da TDK-Lambda Americas Inc.

## CONDIÇÕES AMBIENTAIS











A aprovação de segurança das fontes de alimentação da série Genesys™ aplica-se às seguintes condições de funcionamento:

\*Utilização no interior

\*Temperatura ambiente: De 0°C a 50°C

\*Humidade relativa máxima: 80% (sem condensação) \*Altitude: até 3000m

\*Nível de poluição 2

	ATENÇÃO: Respeitar as precauções relativas ao manuseamento de dispositivos sensíveis a electricidade estática.
	CUIDADO: Risco de choque eléctrico
	Símbolo do manual de instruções. O instrumento será assinalado com este símbolo sempre que for necessário que o utilizador consulte o manual de instruções.
	Indica tensão perigosa.
	Assinala um terminal de ligação à terra.
	O terminal do condutor de terra de protecção deve estar ligado à terra.
	Desactivado (alimentação)
	Activado (alimentação)
	O sinal de AVISO assinala um perigo. Solicita-se atenção para um procedimento. Não seguir correctamente o procedimento pode resultar em ferimentos. Não se deve ignorar um sinal de AVISO, e todas as condições indicadas devem ser compreendidas e respeitadas.
	O sinal de CUIDADO assinala um perigo. Solicita-se atenção para um procedimento. Não seguir correctamente o procedimento pode resultar em danos no equipamento. Quando encontrar um sinal de CUIDADO não avance até que todas as condições indicadas tenham sido completamente entendidas e respeitadas.



## INSTRUÇÕES DE SEGURANÇA

### **DECLARAÇÃO DE CONFORMIDADE FCC:**

Nota: Este equipamento foi testado e considerado estar dentro dos limites necessários para um dispositivo digital da Classe A, em conformidade com a parte 15 das normas da FCC. Estes limites estão concebidos de forma a fornecer uma protecção razoável contra interferências nocivas quando o equipamento é utilizado num ambiente comercial. Este equipamento gera, utiliza, e pode emitir energia por radiofrequência e, caso não seja instalado e utilizado de acordo com o manual de instruções, pode provocar interferências nocivas nas comunicações por rádio. A utilização deste equipamento numa área residencial poderá provocar interferências nocivas, situação na qual a correcção da interferência ficará ao encargo do próprio utilizador.

## SPANISH

### SAFETY INSTRUCTIONS INSTRUCCIONES DE SEGURIDAD

#### PRECAUCIÓN

La siguiente precaución de seguridad debe ser respetada durante todas las fases de funcionamiento, mantenimiento y reparación de este equipo. El incumplimiento de las precauciones o advertencias de seguridad recogidas en este documento infringe las normativas de seguridad de diseño, fabricación y uso previsto de este equipo y puede afectar a las protecciones incorporadas en el mismo.

TDK-Lambda Americas Inc. no asumirá responsabilidad alguna si el usuario no cumple estos requisitos.

#### CATEGORÍA DE INSTALACIÓN

La serie de fuentes de alimentación Genesys™ ha sido evaluada conforme a la CATEGORÍA DE INSTALACIÓN II. Categoría de instalación (categoría de sobretensión) II: equipos de nivel local, eléctricos, portátiles, etc. Con una sobretensión transitoria menor que la Categoría de Instalación (categoría de sobretensión) III.

#### CONEXIÓN A TIERRA

Este producto es un aparato de Seguridad de Clase 1. Para minimizar el riesgo de descargas, el chasis del aparato se debe conectar a una toma de tierra eléctrica. El aparato se debe conectar a la toma de energía eléctrica de corriente alterna de la red de distribución a través de un cable de alimentación de tres conductores, con el conductor de tierra firmemente conectado a una toma de tierra eléctrica (toma de tierra de seguridad) de la toma de corriente.

En el caso de aquellos aparatos diseñados para quedar cableados a la red de alimentación, el borne de tierra de protección se debe conectar a la toma de tierra eléctrica de seguridad antes de establecer cualquier otra conexión. Cualquier interrupción del conductor de tierra de protección o desconexión del borne de tierra de protección supondrá un riesgo potencial de descarga eléctrica que puede llegar a causar daños personales.

#### WARNING ADVERTENCIA

##### CONEXIÓN A TIERRA DE LOS BORNES DE SALIDA



El uso de fuentes de alimentación con una tensión nominal o combinada superior a 400V y la Salida Positiva de la Fuente de Alimentación conectada a tierra, representa un riesgo potencial de descarga en los puertos RS-232/RS-485, LAN e IEEE.

No conecte la Salida Positiva a tierra si va a utilizar los puertos RS-232/RS-485, LAN o IEEE.

#### FUSIBLES

Los fusibles sólo pueden ser cambiados por el personal de servicio autorizado de TDK-Lambda Americas Inc. Para una protección permanente contra el peligro de incendios, utilice únicamente fusibles del mismo tipo y de la misma potencia nominal.

#### POTENCIAS NOMINALES DE ENTRADA

No utilice fuentes de alimentación de CA cuyos valores nominales superen los de la tensión y frecuencia de entrada de este aparato. Los valores nominales de la tensión y frecuencia de entrada de la serie de fuentes de alimentación Genesys™ tienen tres rangos de entrada dependiendo del tipo de modelo elegido. Los rangos son 180-253VAC/342-440VAC/432-528VAC, 50-60Hz. Por razones de seguridad, las fluctuaciones en la tensión de alimentación de la red no deberían superar los rangos de tensión antedichos.

## INSTRUCCIONES DE SEGURIDAD

### CIRCUITOS ACTIVOS

El personal operativo no debe retirar la cubierta del aparato. Los ajustes internos o el reemplazo de componentes sólo pueden ser realizados por el personal cualificado de TDK-Lambda Americas Inc. Desenchufe siempre el cable de alimentación antes de reemplazar los componentes. Para evitar lesiones, desenchufe siempre el cable de alimentación, descargue los circuitos y desconecte la fuente de tensión externa antes de tocar los componentes.

### SUSTITUCIÓN Y MODIFICACIÓN DE LAS PIEZAS

Las piezas sólo pueden ser sustituidas o modificadas por el personal de servicio autorizado de TDK-Lambda Americas Inc. Para cualquier reparación o modificación del aparato, éste debe ser enviado a un centro de servicio autorizado de TDK-Lambda Americas Inc.

### CONDICIONES MEDIOAMBIENTALES

La aprobación de seguridad de la serie de fuentes de alimentación Genesys™ es aplicable a las siguientes condiciones de funcionamiento:











\*Uso en interiores

\*Temperatura ambiente: 0°C a 50°C

\*Humedad relativa máxima: 80% (sin condensación)

\*Altitud: hasta 3000m

\*Grado de contaminación 2

	ATENCIÓN Observe las precauciones de manejo de dispositivos sensibles electrostáticos
	PRECAUCIÓN Riesgo de descargas eléctricas
	Símbolo de manual de instrucciones. Este símbolo se pondrá en el aparato siempre que el usuario tenga que consultar el manual de instrucciones.
	Indica una tensión peligrosa.
	Indica un borne de tierra.
	El borne del conductor de tierra de protección debe estar conectado para poder establecer una conexión a tierra.
	Apagado (fuente de alimentación)
	Encendido (fuente de alimentación)
	El símbolo de ADVERTENCIA indica un peligro. Llama la atención ante un procedimiento. Si el procedimiento no se realiza correctamente, podrían producirse lesiones personales. Los símbolos de ADVERTENCIA no se pueden pasar por alto y deben comprenderse y cumplirse todas las condiciones indicadas.
	El símbolo de PRECAUCIÓN indica un peligro. Llama la atención ante un procedimiento. Si el procedimiento no se realiza correctamente, el equipo podría sufrir daños. Cuando encuentre un símbolo de PRECAUCIÓN, no siga hasta que no haya comprendido y esté seguro de que se cumplen las condiciones indicadas.

## **INSTRUCCIONES DE SEGURIDAD**

### **DECLARACIÓN DE CONFORMIDAD CON LA FCC:**

Nota: Este equipo ha sido ensayado y cumple con los límites establecidos para los dispositivos digitales de Clase A, de conformidad con lo dispuesto en el Apartado 15 de la normativa de la FCC. Estos límites han sido diseñados para proporcionar una protección razonable contra interferencias perjudiciales cuando el equipo se utilice en entornos comerciales. Este equipo genera, usa y puede emitir energía de radiofrecuencia y, si no se instala y utiliza de acuerdo con el manual de instrucciones, puede ocasionar interferencias perjudiciales con las comunicaciones por radio. La utilización de este equipo en un área residencial puede llegar a provocar interferencias perjudiciales, en cuyo caso se le pedirá al usuario que las corrija y que se haga cargo del gasto generado.

# 1. GENERAL INFORMATION

---

## 1.1. User Manual Content

This User's Manual contains the operating instructions, installation instructions and specifications of the Genesys™ 10kW and 15kW Power Supply series. The instructions refer to the standard power supplies, including the built-in RS-232/RS-485 serial communication. For information related to operation with the optional IEEE programming interface, refer to User's Manual for Power Supply IEEE/IEMD Programming Interface. For information related to operation with the optional LXI certified LAN programming interface, refer to the User's Manual for Power Supply LAN Programming Interface.

## 1.2. Introduction

### 1.2.1. General Description

Genesys™ power supplies are wide output range, high performance switching power supplies. The Genesys™ series is power factor corrected and operates from specified AC voltage range continuously. Output voltage and Output current are continuously displayed and LED indicators show the complete operating status of the Power Supply. The Front panel controls allow the user to set the output parameters, the protections levels (Over-Voltage protection, Under-Voltage limit and Foldback) and preview the settings. The rear panel includes the necessary connectors to control and monitor the Power Supply operation by remote analog signals or by the built-in serial communication (RS-232/RS-485). LXI certified LAN programming, GPIB programming and Isolated-Analog programming/Monitoring (5V/10V and 4-20mA) are optional

### 1.2.2. Features and Options

- Constant Voltage / Constant Current with automatic crossover.
- Passive power factor correction (PFC).
- Embedded Microprocessor Controller.
- Built-in RS-232/RS-485 Interface.
- Voltage & Current high resolution adjustment by digital encoders.
- High accuracy programming/ readback.
- Software Calibration (no internal trimmers/potentiometers)
- Last Setting Memory.
- Independent Remote ON/OFF (opto-isolated) and remote Enable/Disable.
- Parallel operation (Master/Slave) with Active current sharing.
- Remote sensing to compensate for voltage drop of power leads.
- External Analog Programming and Monitoring standard (0-5V or 0-10V, user selectable).
- Cooling fan speed control for low noise and extended fan life.
- Zero stacking. No ventilation required at the top and bottom surface of the power supply.
- Optional LXI certified LAN (Class C) and IEEE 488.2 interfaces are SCPI compliant.
- Optional Isolated Analog programming/monitoring (0-5V/0-10V, user selectable, or 4-20mA).

### 1.2.3. Multiple Output Power System

The Genesys™ Power Supply series can be configured into a programmable power system of up to 31 units using the built-in RS-232/RS-485 communication port and the RS-485 Linking cable.

In a GPIB system, each Power Supply can be controlled using the optional GPIB interface (factory installed).

In a LAN system, each Power Supply can be controlled using the optional LXI certified LAN interface (factory installed).

#### **1.2.4. Control via the Serial Communication Port**

The following parameters can be programmed via the serial communication port:

- a) Output voltage setting.
- b) Output current setting.
- c) Output voltage measurement.
- d) Output On/Off control.
- e) Output current measurement.
- f) Foldback protection setting
- g) Over-voltage protection setting and readback.
- h) Under-Voltage limits setting and readback.
- i) Power Supply start up mode (last setting or safe mode).

#### **1.2.5. Analog Voltage Programming and Monitoring**

Analog inputs and outputs are provided at the rear panel for Remote Analog control of the Power Supply. The Output voltage and the Output current limit can be programmed by analog voltage or by resistor, and can be monitored by analog voltage. The Power Supply output can be remotely set to On or Off and analog signals monitor the proper operation of the Power Supply and the mode of operation (CV/CC).

#### **1.2.6. Parallel Operation**

Genesys™ power supplies of the same Output voltage and Output current rating can be paralleled in Master-Slave configuration with automatic current sharing to increase user-available Output power available.

#### **1.2.7. Output Connections**

Output connections are made to rear panel via bus-bars up to  $V_{out} = 300V$  and via stud terminals for models with  $V_o > 300V$ . Either the positive or negative terminal may be grounded or the entire Output may be floated. All models shall not float outputs more than  $\pm 600VDC$  above/below Chassis ground. Contact the factory for assistance with higher float voltage applications.

Local or remote sense may be used. In remote sense, the voltage drop on the load wires should be minimized. Refer to the Power Supply specifications of Section 2 for the remote sense maximum voltage drop value.

#### **1.2.8. Cooling and Mechanical Construction**

The Genesys™ Power Supply Series is cooled by internal fans. During installation, care must be taken to allow free airflow into the Power Supply via the front panel and out of the Power Supply via the rear panel.

#### **CAUTION**

Observe all torque guidelines within this User's Manual. Over-torquing hardware may damage the unit or accessories. Such damage is not covered under Manufacturer's Warranty.

### 1.3. Accessories

1.3.1. **Included Accessories** - The following accessories are **delivered with the Power Supply**.

- **Hardware:**
  - AC Input terminal cover
  - Output busbar terminal cover
  - DB25 Programming Plug kit (AMP 749809-9) (may be optional)

### 1.3.2. Communication Cables (optional)

- RS-232 Cables (to connect GEN to Serial Port on PC).

GEN to PC (DB-9F)	GEN/232-9	P/N: 15-507-203
GEN to PC (DB-25F)	GEN/232-25	P/N: 15-507-204

- RS-485 Cable (to connect GEN to Serial Port on PC).

GEN to PC (DB-9F)	GEN/485-9	P/N: 15-507-202
-------------------	-----------	-----------------

### 1.3.3. Serial Link Cable (optional)

- Cable description: 0.5m length, shielded, RJ45 type plugs, 8 contacts

Serial Link (RJ-45 Type)	GEN/RJ-45	15-507-201
--------------------------	-----------	------------

### 1.3.4. AC cables – Not applicable.

### 1.4. Model Number Format

The model numbering system for Genesys™ Power Supply Series includes symbols for features and options. They are separated by dashes.

The following chart explains the model number for the GEN Power Supply Family.

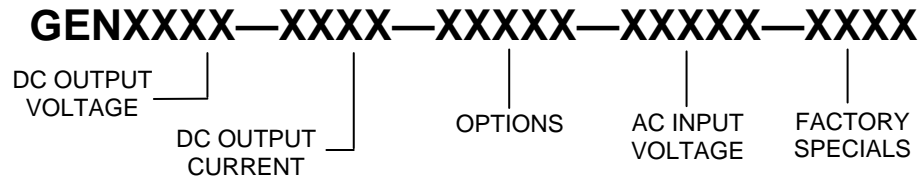

Option		AC Input Volts		Factory Specials
Note 5		Note 1,2,3		Note 4
<b>IS510</b>	ISOL PROG 0-5V/0-10V	<b>3P208</b>	208VAC,3 $\phi$ , 47 / 63Hz	Blank for standard supplies
<b>IS420</b>	ISOL PROG 4-20mA	<b>3P400</b>	400VAC,3 $\phi$ , 47 / 63Hz	
<b>IEMD</b>	IEEE W/ MULTI-DROP			
<b>LAN</b>	LXI CERTIFIED ETHERNET OPTION			

*Note 1: See “Specifications” for AC Input Voltage Range.*

*Note 2: CE Mark with IEMD to 400VDC Output, without IEMD to 600VDC Output.*

*Note 3: All 3 $\phi$  are four wire input = 3 $\phi$  + GND (No Neutral).*

*Note 4: Analog Meters are NOT available.*

*Note 5: Factory Installed; IS510, IS420, IEMD, or LAN may not be installed together.*

*Limit one (1) per Power Supply.*

**EXAMPLES:**      GEN10-1000-3P208  
                           GEN10-1000-IEMD-3P400  
                           GEN10-1000-IEMD-3P400-1292



## 2. SPECIFICATIONS

All specifications are subject to change without notice.

Contact factory for specific model availability.

### 2.1. Output Rating (Duty Cycle Continuous Duty).

#### 2.1.1. Standard Models – 10kW

1. Rated Output voltage	V	7.5	10	12.5	20	25	30	40	50	60	80	100	125	150	200	250	300	400	500	600
2. Rated Output current	A	1000	1000	800	500	400	333	250	200	167	125	100	80	66	50	40	33	25	20	17
3. Rated Output power	kW	7.5	10.0	10.0	10.0	10.0	10.0	10.0	10.0	10.0	10.0	10.0	10.0	9.9	10.0	10.0	9.9	10.0	10.0	10.2

#### 2.1.2. Standard Models – 15kW

1. Rated Output voltage	V	N/A	N/A	N/A	N/A	N/A	30	40	50	60	80	100	125	150	200	250	300	400	500	600
2. Rated Output current	A	-	-	-	-	-	500	375	300	250	187.5	150	120	100	75	60	50	37.5	30	25
3. Rated Output power	kW	-	-	-	-	-	15.0	15.0	15.0	15.0	15.0	15.0	15.0	15.0	15.0	15.0	15.0	15.0	15.0	15.0

### 2.2. Input Characteristics

	V	7.5	10	12.5	20	25	30	40	50	60	80	100	125	150	200	250	300	400	500	600
1. Input voltage/freq. (range)	---	208VAC (180-253), 400VAC (342-440), 480VAC (432-528), all 47-63Hz																		
2. # of phases	---	3 Phase (Wye or Delta) 4 wire total (3 Phases and 1 Protective Earth ground)																		
3. Dropout voltage	V	175/338/425																		
4. Input current 180/342/432 VAC	A	10kW – 45/23/20, 15kW – 64/32/27; All at full rated Output power.																		
5. Power Factor (typical)	---	0.88 Passive (208VAC, 400VAC, 480VAC)																		
6. Efficiency at Low Line, 100% load	%	77 min for 7.5kW, 83 min for 10kW, 88 min for 15kW																		
7. Inrush current	A	Not to exceed full rated Input current																		
8. Leakage current	mA	3.5 (EN60950-1) max																		
9. Input Protection	---	Circuit breaker for 7.5V, 10V and 12.5V Outputs @ 10kW with 208VAC input.																		
10. Fuse	---	Fuse for: 7.5V, 10V and 12.5V Outputs @ 10kW with 400VAC/480VAC input. Fuse for: 20V ≤ Vout ≤ 600V @ 10kW/15kW with 208VAC/400VAC/480VAC input.																		
11. Input Overvoltage Protection		Unit shall not be damaged by line overvoltage with maximum duration of 100uSec. Up to 120% of nominal AC input voltage.																		
12. Phase Imbalance	%	≤ 5% on Three Phase Input																		

### 2.3. Static Characteristics

	V	7.5	10	12.5	20	25	30	40	50	60	80	100	125	150	200	250	300	400	500	600	
1. Max. line regulation, CV	---	0.1% of FS from Io(min) to Io(max).						0.01% of FS from Io(min) to Io(max).													
2. Max. line regulation, CC	---	0.1% of FS from Vo(min) to Vo(max).						0.05% of FS from Io(min) to Io(max).													
3. Max load regulation, CV	---	0.1% of FS from Io(min) to Io(max).						0.02% of FS Io(min) to Io(max).													
4. Max load regulation, CC	---	0.1% of FS from Vo(min) to Vo(max).						0.075% of FS from Vo(min) to Vo(max).													
5. Temperature Stability, CV	---	+/- 0.05% of Vo(rated) over 8 hours after 30 minute warm up (constant Line, Load & Temperature).																			
6. Temperature Stability, CC	---	+/- 0.05% of Io(rated) over 8 hours after 30 minute warm up (constant Line, Load & Temperature).																			
7. Temperature Coefficient, CV	PPM/C	200 (0.02% of Vo(rated)/Degree C)																			
8. Temperature Coefficient, CC	PPM/C	300 (0.03% of Io(rated)/Degree C)																			
9. Output noise p-p (20MHz), CV	mV	60	60	60	60	60	60	60	75	75	100	100	125	150	175	200	200	300	350	350	
10. Ripple r.m.s 5Hz~1MHz, CV	mV	20	20	20	20	20	20	20	20	20	25	25	25	25	35	35	60	60	60	60	
11. Ripple r.m.s 5Hz~1MHz, CC (10kW)	mA	5300	4000	2560	1000	640	444	250	160	67	50	40	32	26	20	16	13	10	8	7	
12. Ripple r.m.s 5Hz~1MHz, CC (15kW)	mA	-	-	-	-	-	350	200	150	100	100	100	50	50	20	20	20	10	10	10	
13. Rem. sense compensation/wire	V	1	1	1	1	1	1.5	2	3	3	4	5	5	5	5	5	5	5	5	5	

\*Ripple and Noise at Vo(rated) and rated load at 25°C, nominal AC input, per EIJ RC9002A

## 2.4. Protective Functions

	V	7.5	10	12.5	20	25	30	40	50	60	80	100	125	150	200	250	300	400	500	600	
1. OCP	%	0 ~ 100%																			
2. OCP Type	---	Constant current																			
3. Knee point protection	---	None, No damage at knee point operation																			
4. Short circuit protection	---	Yes																			
5. Foldback protection	---	Output shut down when power supply changes from CV to CC mode, manual reset by front panel OUT button or Digital Communication, user-selectable.																			
6. Foldback response time	S	Min = 0.25/Max = 25, Default = 0.25 Settable via "FBD" command using Digital Communication command.																			
7. OVP Type	---	Inverter shut-down, manual reset by AC input recycle, by front panel OUT button, Remote Analog or Digital Communication command.																			
8. OVP programming accuracy	%	+/- 5% of Vo(rated)																			
9. OVP adjustment method	---	Adjust by front panel Voltage encoder and Digital Communication command.																			
10. OVP trip point	V	5% to 105% of Vo(rated) and shall always be greater than 105% of the Output voltage setting. Default = 105% of Vo(rated)																			
11. OVP response time	mS	Less than 10mS for Output voltage to begin to drop.																			
12. Max. OVP reset time	S	7 (from AC On/Off switch turn On)																			
13. Output Under Voltage limit	---	Prevents adjusting Output voltage below limit. Preset by the front panel or Digital Communication command. 0-95% of Vo(rated) and shall always be less than 95% of the Output voltage setting. Raises the PS_OK signal when Vout is below limit. Does not affect J1 Remote Analog programming. Default = 0V.																			
14. Input Under Voltage protection	---	Yes, power supply shutdown below AC Input low line (non-latching).																			
15. Over Temperature protection	---	Unit shall shut down when internal temperature exceeds safe operating levels. (Latched in Safe-mode and unlatched in Auto-mode).																			
16. Phase Loss Protection		Yes, power supply shutdown after phase-loss detection (non-latching).																			

## 2.5. Dynamic Characteristics

	V	7.5	10	12.5	20	25	30	40	50	60	80	100	125	150	200	250	300	400	500	600	
1. Up-prog. Response time, 0-Vo(rated), full-load	mS	100	100	100	100	100	100	100	100	100	100	100	100	100	100	100	100	100	100	100	
2. Up-prog. Response time, 0-Vo(rated), no load	mS	50	50	50	50	50	50	50	50	50	50	50	50	50	50	50	50	50	50	50	
3. Down-prog response time full-load	mS	100	100	100	100	100	100	100	100	100	100	100	100	100	100	100	100	100	100	100	
4. Transient response time (CV mode)	mS	Less than 3. Time for Vo to recover to within 2% of Vo(rated) for a load change of 50 to 100% or 100 to 50% of Io(rated).																			
5. Time for Output Stable	S	2 maximum, from Enable Output until Output stable (within 2% of steady-state).																			
6. Output fall and rise	---	Overshoot limited to 125% Rated Output. Voltage at No-Load, Full-Load, Resistive Load.																			
7. Start-Up delay	S	Less than 7 (without IEEE option installed)																			
Note: Items 2.5.1 through 2.5.7 with resistive load.																					

## 2.6. Remote Analog Control And Signals

1. Vout voltage programming	---	0~100%, 0~5V or 0~10V, user selectable. Accuracy & Linearity +/-1% of Vo(rated).
2. Iout voltage programming	---	0~100%, 0~5V or 0~10V, user selectable. Accuracy & Linearity +/-1% of Io(rated).
3. Vout resistor programming	---	0~100%, 0~5/10kohm full scale, user selectable. Accuracy & Linearity +/-1% of Vo(rated).
4. Iout resistor programming	---	0~100%, 0~5/10kohm full scale, user selectable. Accuracy & Linearity +/-1% of Io(rated).
5. Shut-Off control (SO)	---	By voltage: 0.6V = Disable, 2-15V = Enable (default) or Dry Contact: Open = Enable, Short = Disable, user selectable logic
6. Output current monitor	---	0~5V or 0~10V, user selectable, Accuracy +/-1%
7. Output voltage monitor	---	0~5V or 0~10V, user selectable, Accuracy +/-1%
8. Power supply OK signal (PS_OK)	---	Yes. TTL high = OK, 0V = Fail / Output OFF (500ohm series resistance)
9. Single-Wire Parallel operation	---	Up to four (4) identical units may be connected in Basic or Advanced Master/Slave Mode with Single-Wire connection for Output Voltage Models where $7.5V \leq V_{out} \leq 25V$ (10kW). In Advanced Parallel mode, the Master displays the calculated (not actual) Output current for the combined parallel combination on the front panel and is made available via the digital interface. Remote analog current of the Master unit is scaled to its actual Output current (only).
10. Two-Wire Parallel operation	---	Up to four (4) identical units may be connected in Basic or Advanced Master/Slave mode with Two-Wire connection for Output Voltage Models where $25V \leq V_{out} \leq 600V$ (10kW/15kW). Same Operation as Single-Wire in Advanced Parallel mode.
11. Series operation	---	Possible (with external diodes), up to identical 2 units with total Output voltage not to exceed +/-600V from chassis ground.
12. CV/CC signal	---	CV: TTL high (4~5V), Max source current = 10mA, CC: TTL low (0.0~0.4V), Max sink current = 10mA
13. Enable/Disable	---	Dry contact. Open: Off, Short: On. Maximum voltage at Enable/Disable In = 6V
14. Remote/Local Control	---	Selects Remote or Local operation by Voltage: 0-0.6V = Local, 2-15V = Remote.
15. Remote/Local signal	---	Open collector: Local = Open (Maximum voltage = 30V), Remote = On (Maximum sink current 10mA)

## 2.7. Front Panel

1. Control functions	---	Vout/ Iout manual adjust by separate encoders (coarse and fine adjustment).	
	---	OVP/UVL manual adjust by Voltage Adjust encoder.	
	---	Address selection by Voltage adjust encoder. Range = 0 to 30	
	---	Go to Local control	
	---	Output On/Off	
	---	AC On/Off	
	---	Foldback control (CV to CC)	
	---	RS-232/RS-485, IEEE488.2, LAN selection by rear panel DIP-switch	
	---	Baud rate selection by Current adjust encoder: 1200, 2400, 4800, 9600 and 19200 (RS-232/RS-485 communication only)	
	---	Re-start modes (Auto-Restart, Safe-Restart)	
	---	Front Panel Lock/Unlock	
	---	Parallel Master Slave: H1 = One Master, Zero Slave H2 = One Master, One Slave H3 = One Master, Two Slaves H4 = One Master, Three Slaves S = Slave	
	2. Display	---	Vout:
---		Iout:	4 digits, Accuracy: +/-0.5% of rated Iout +/- 1count, Green LED's, Size:10mm
		Voltmeter displays voltage at power supply output (local sense) or at load (remote sense).	
		VOLT Display: PREV setting for Vout, Actual Vout, OVP/UVL settings, SAF/AUT Restart mode, OUT OFF or fault, LFP/UFP setting, RS-232/RS-485 Address setting, IEEE or LAN Enabled and Address	
		CURR Display: PREV setting for Iout, Actual Iout, OVP/UVL, RS-232/RS-485 Baud rate setting, H1-H4 or S	
3. Indications	---	Green LED's:	PREVIEW, FOLD, REM/LOCAL, OUT ON/OFF, CC/CV, FINE
		Red LED:	ALRM (OVP, OTP, FOLD, AC FAIL, ENA, SO)

## 2.8. Software Spec.

1. Functions:		1. Voltage/Current setting
		2. OVP/UVL setting
		3. Actual voltage/current setting readback
		4. Voltage/current setting readback
		5. OVP/UVL setting readback
		6. Output On/Off
		7. Foldback protection setting
		8. Status readback (cc/cv, ovp, otp, foldback, ac fault)
		9. Model identification readback
		10. Calibration (not user access.) (DAC-Zero and max points, Display-Zero and max.)
		11. Last setting recall (at power off).
		12. Re-start mode setting
		13. Front Panel Lock/Unlock
		14. IEEE (Optional)
		15. Multi-Drop Serial
		16. Parallel Master/Slave operation with a single display.
		17. LXI Certified LAN (Optional)
		18. USB (Optional)
2. Application software:		1. Drivers to LabView and LabWindows
		2. Simple operating program

## 2.9. Digital Programming And Readback

1. Vout programming accuracy	---	+/-0.5% of rated Output voltage
2. Iout programming accuracy	---	+/-0.5% of rated Output current for units with $I_o < 187.5$ ; +/-0.7% of rated output current for $I_o \geq 187.5$
3. Vout programming resolution	---	0.02% of full scale
4. Iout programming resolution	---	0.04% of full scale
5. Vout readback accuracy	---	+/- (0.1% of $V_o(\text{actual}) + 0.2\%$ of $V_o(\text{rated})$ )
6. Iout readback accuracy	---	+/- (0.1% of $I_o(\text{actual}) + 0.4\%$ of $I_o(\text{rated})$ )
7. Vout readback resolution	---	0.02% of full scale
8. Iout readback resolution	---	0.02% of full scale
9. OV Response Time	mS	20mS maximum between output V exceeding IEEE limit and supply inhibit turning on.
10. Other Functions	---	Set OVP/UVL Limits, Set Local/Remote, Identity, Calibration

## 2.10. Mechanical Construction

	V	7.5	10	12.5	20	25	30	40	50	60	80	100	125	150	200	250	300	400	500	600	
1. Cooling	---	Fan driven (variable speed), Airflow from Front to Rear. Supplemental vents on side that shall not be blocked. EIA Rack mounting, stackable. "Zero Stackable" top and bottom. Slides or suitable rear support required.																			
2. Weight	Kg/Lb	43/97 for $V_{out} < 30V$ ; 40/90 for $30 \leq V_{out} \leq 600V$																			
3. Dimensions	---	W: 429mm/16.9", H: 3U – 133mm/5.22" D: 564mm/22.2" (excluding connectors, encoders, handles, etc.)																			
4. Types of connectors	---	1) AC Input: 4xM6x1" threaded studs (L1, L2, L3 and Chassis GND) and terminal cover. 2) Output: $I_{out} \geq 50A$ : bus-bars, $I_{out} < 37.5$ : threaded stud terminal 3) Analog programming: DB25, plastic connector, AMP, 747461-5, Female on Power Supply, Male on Mating connector 747321. Standard 25 pin Sub-D connector. 4) RS-232/RS-485, STD RJ-45 Phone Jack connector 5) Isolated Analog Option: refer to Isolated Analog Option Spec. 08-030-200 6) IEMD Option: refer to IEMD Option Spec. 08-030-100. 7) LAN Option: refer to LAN Option Spec. 08-034-100																			
5. Front panel material & finish	---	RAL7035, Textured finish.																			
6. Mounting method	---	Standard 19" Rack Mount, provision for standard slides. Side/Rear Support is required; do not mount by Front Panel only.																			
7. Mounting positions	---	Horizontal																			
8. Output ground connection	---	M5x0.9" threaded stud																			
9. Color and finish	---	Chassis (Top/Sides/Bottom): Clear Iridite, Front Panel RAL7035 painted.																			
10. Output Terminal covers	---	Standard for all models with bus-bars. Closed connection for models with output connector.																			

## 2.11. Environmental Conditions

1. Operating temp	C	0 ~50°C, 100% load. No operation > 50°C
2. Start up temp.	C	0
3. Storage temp	C	-20°C to +70°C
4. Operating humidity	%	20~80% RH (non-condensing)
5. Storage humidity	%	10~90% RH (non-condensing)
6. Altitude	---	Operating: 50°C up to 7500ft (2500m), 45°C from 7501 to 10,000ft (2501m – 3000m) Non Operating 40,000 ft (12,000m)
7. Vibration & Shock (208/400/480VAC)	G	ASTM D4169, Standard Practice for performance Testing of Shipping Containers and Systems, Distribution Cycle: Cy Air (intercity) and motor freight (local, single package up to 100lbs.). Shipping Unit: Single Package Assurance Level: Level II; Acceptance Criteria: Criterion 1 – No product damage, Criterion 2 – Package is intact.
8. Audible Noise	db	Less than 70dBA at Full Load, measured 1m from Front Panel

## 2.12. EMC

		CE Mark
1. ESD	---	EN61000-4-2 (IEC 1000-4-2): Air-disch. +/-8kV, contact disch. +/-4kV
2. Fast transients	---	EN61000-4-4 (IEC 1000-4-3): +/-2kV: AC Power, 2kV: DC Output
3. Surge immunity	---	EN61000-4-5 (IEC 1000-4-5): 1kV line-to-line, 2kV line-to-ground
4. Conducted immunity	---	EN61000-4-6 (IEC 1000-4-6): 10Vrms
5. Radiated immunity	---	EN61000-4-3 (IEC 1000-4-3): 10V/m
6. Power Frequency Magnetic Field	---	EN61000-4-8: 30A/m
7. Conducted emission	---	EN55011A, FCC part 15J-A
8. Radiated emission	---	EN55011A, FCC part 15J-A
Note: EMC Approval for:	Vout < 30V @ 208VAC/400VAC 30V ≤ Vout ≤ 600V @ 208VAC/400VAC/480Vac	

## 2.13. Safety

1. Applicable Standards	---	UL/cUL 60950-1, EN60950-1 recognized (CB Scheme) All Outputs are Hazardous. For Vout ≤ 400VDC: IEEE, LAN, IS510 or IS420 are SELV. CE mark for all inputs (208VAC, 400VAC, 480VAC).
2. Insulation resistance	---	100Mohm at 500Vdc, 25°C, 70% Relative Humidity

## 2.14. J1 Connector

J1-1		ENA_IN	Enable/Disable Dry Contact with J1-14 (ENA_OUT)
J1-2		IF_COM	Isolated Interface Common. Return for SO, PS_OK, and optional IEEE interface.
J1-3		IF_COM	Isolated Interface Common. Return for SO, PS_OK, and optional IEEE interface.
J1-4		N/C	
J1-5		N/C	
J1-6		N/C	
J1-7		N/C	
J1-8		LOC/REM	Input for selecting between Local or Remote Analog programming.
J1-9		VPGM	Input for Remote Analog voltage/resistance programming of the Output Voltage
J1-10		IPGM	Input for Remote Analog voltage/resistance programming of the Output Current
J1-11		VMON	Output Voltage Monitor
J1-12		COM	Control Common for VMON & IMON, CV/CC, LOC/REM signal and P (2-Wire Parallel method only). Connected internally to the negative local sense (-LS)
J1-13		CV/CC	Output for Constant Voltage / Constant Current mode indication
J1-14		ENA_OUT	Enable/Disable Dry Contact with J1-1 (ENA-IN)
J1-15		SO	Input for Shut-Off control of the power supply output.
J1-16		PS_OK	Output for indication of the power supply status
J1-17		N/C	
J1-18		N/C	
J1-19		N/C	
J1-20		N/C	
J1-21		LOC/REM Signal	Output for indicating if the unit is in Local or Remote Analog programming mode.
J1-22		VPGM_RTN	Return for VPGM J1-9; connected to negative local sense (-LS).
J1-23		IPGM_RTN	Return for IPGM J1-10; connected to negative local sense (-LS).
J1-24		IMON	Output for Current Monitor
J1-25		P	Output for Current Balance in Parallel Option (all methods)

### 3. INSTALLATION

---

#### 3.1. General

This Chapter contains instructions for initial inspection, preparation for use and repackaging for shipment. Connection to the PC, setting the communication port and linking Genesys™ power supplies are described in Chapter 8.

**NOTE**

Genesys™ power supplies generate magnetic fields, which might affect the operation of other instruments. If your equipment is susceptible to magnetic fields, do not position it adjacent to the Power Supply.

#### 3.2. Preparation for Use

In order to be operational, the power supply must be connected to an appropriate AC power source. The AC source voltage should be within the Power Supply specification. Do not apply AC Input power before reading Section 3.6 and 3.7 of this User's Manual.

Table 3-1 below, describes the Basic Setup Procedure. Follow the instructions in Table 3-1 in the sequence given to prepare the Power Supply for use.

Step no.	Item	Description	Reference
1	Inspection	Initial physical inspection of the Power Supply	Section 3.3
2	Installation	Installing the Power Supply, Ensuring adequate ventilation.	Section 3.4 Section 3.5
3	AC source	AC source requirements Connecting the power supply to the AC source	Section 3.6 Section 3.7
4	Test	Turn-on checkout procedure.	Section 3.8
5	Load connection	Wire size selection. Local/Remote sensing. Single or multiple loads.	Section 3.9
6	Default setting	The Power Supply setting at shipment.	Section 3.9.6, 4.4.1, 8.2.1

**Table 3-1: Basic Setup Procedure**

#### 3.3. Initial Inspections

Prior to shipment this Power Supply was inspected and found free of mechanical or electrical defects. Upon unpacking of the Power Supply, inspect for any damage, which may have occurred in transit.

The inspection should confirm that there is no exterior damage to the Power Supply such as broken knobs or connectors and that the front panel and meters face are not scratched or cracked. Keep all packing material until the inspection has been completed. If damage is detected, file a claim with the carrier immediately and notify the TDK-Lambda Americas Inc. Sales or Authorized Service facility nearest you.



### 3.4. Rack Mounting

The Genesys™ Power Supply Series is designed to fit in a standard 19" equipment rack.

#### 3.4.1. To Install the Power Supply in a Rack:

- 3.4.1.1. Use the front panel rack-mount brackets to install the Power Supply in the rack.
- 3.4.1.2. Use a support bar to provide adequate support for the rear of the Power Supply. Do not obstruct the air exhaust at the rear panel of the unit.

#### 3.4.2. Rack Mount Slides (optional, customer provided)

##### CAUTION

Ensure that the screws used to attach the slides are not longer than 8mm.

Use rack-mount slides (General Devices P/N C230-S-122 or equivalent) to install the unit in a standard 19" wide equipment rack. For racks with longer depth, contact the rack-mount slide provider for the proper rack-mount slide to use.

To install the unit into a standard 19" wide equipment rack, refer to rack-mount slide-to-unit assembly instructions. Use four M5x0.8-8mm long (max) pan head screws to attach a slide to one side of the unit. To prevent damage, use the specified screw length only (8mm max.).

### 3.5. Location, Mounting and Cooling

This Power Supply is fan cooled. The air intake is at the front panel and the exhaust is at the rear panel. Upon installation, allow cooling air to reach the front panel ventilation inlets. Unrestricted air space at the front and the rear of the unit is necessary for proper cooling of Power Supply.

The Power Supply should be used in an area where the ambient temperature does not exceed +50°C.

### 3.6. AC Source Requirements

The Genesys™ Series 10kW/15kW power supply can be operated from a nominal three-phase 208VAC, 400VAC or 480VAC, 4 wire, 47–63 Hz AC input. The AC input voltage range and current required for each model is specified in Chapter 2, Section 2.2 (Input Characteristics). Ensure that under heavy load, the AC voltage supplied to the Power Supply does not fall below the specifications described in Chapter 2, Section 2.2 (Input Characteristics).

### 3.7. AC Input Power Connection

##### CAUTION

Connection of this Power Supply to an AC power source should be made by an electrician or other qualified personnel. Do not exceed the torque specified on the AC Input stud terminals.



##### WARNING

There is a potential shock hazard if the Power Supply chassis (with cover in place) is not connected to an electrical safety ground via the safety ground of the AC input threaded-stud terminals.



### WARNING

Some components inside the Power Supply are at AC/DC voltage even when the AC Input On/Off switch is in the “Off” position. To avoid electric shock hazard, disconnect the AC input and load (DC Output) and wait 15 minutes before removing any cover.

The Power Supply AC On/Off switch is not the main disconnect device and does not completely disconnect all internal circuits from the AC power source.

The customer AC Input connects to the Power Supply through four threaded-stud type terminals. Only use a power cable with the correct voltage and current ratings. The recommended wire gauge is listed in the table in Section 3.7.1. The ground wire must be equal to or larger than the recommended gauge for each AC phase.

The Power Supply must be permanently connected to an approved AC distribution box with suitably rated over current protection (60Amp UL Listed fuse for 208VAC input, and 40Amp UL listed fuse for 400VAC/480VAC input).

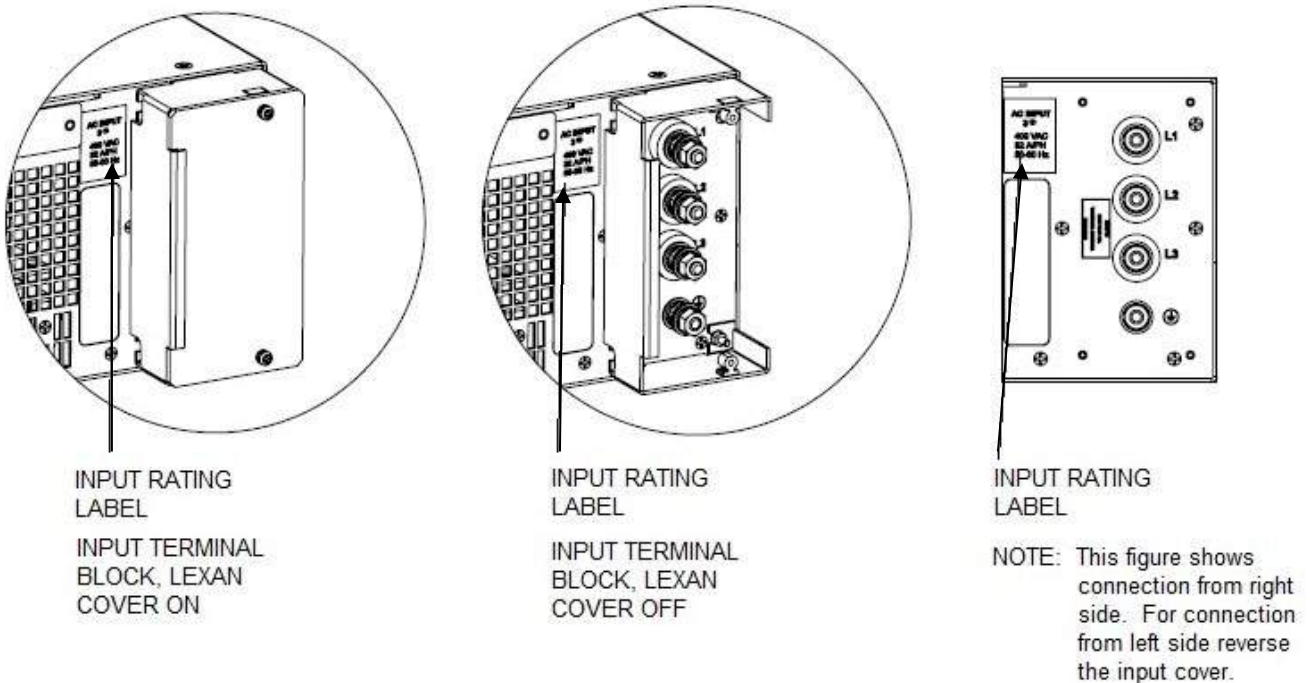

Figure 3-1. AC Input Connections

#### 3.7.1. Recommended Cable Size for AC Input Connection

INPUT VOLTAGE (VAC)	CURRENT PER PHASE (Arms)	RECOMMENDED COPPER WIRE SIZE
208	75	4 AWG
400	45	6 AWG
480	35	7 AWG

The AC input current and voltage rating is marked on the rear terminal of the Power Supply.



The Protective Earth Ground  must be connected before applying AC Line Power to the Power Supply.

### 3.8. Turn-On Checkout Procedure

#### 3.8.1. General

The following procedure ensures that the Power Supply is operational and may be used as a basic incoming inspection check. Refer to Fig. 4-1 and Fig. 4-2 for the location of the controls indicated in the procedure.

#### 3.8.2. Prior to Operation

- a) Ensure that the Power Supply is configured to the default setting:
  - AC On/Off switch at the Off position.
  - Dip switch (SW1): All positions at Down (“Off”) position.
  - Remote Sense connector (J2): configured to Local Sense (as shown in Fig.3-2)

- 1 Remote (+) sense
- 2 Local (+) sense
- 3 Not connected
- 4 Local (-) sense
- 5 Remote (-) sense

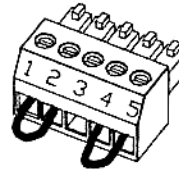

**Figure 3-2: Sense connector default connection**

- For units equipped with IEEE option, ensure that the IEEE\_Enable switch is in the UP (default) position (Refer to Fig. 4-2, Item 9 for location) if Turn-On checkout is to be done in IEEE mode.
- b) Connect the unit to an AC power source as described in Section 3.7.
  - c) Connect a DVM with appropriate cables for the rated Output voltage across the DC Output terminals.
  - d) Press the front panel AC ON/OFF switch to the On position.

#### 3.8.3. Constant Voltage Check

- a) Turn on the output by pressing the OUT pushbutton (the front panel OUT LED should illuminate).
- b) Observe the Power Supply VOLT display and rotate the Voltage encoder. Ensure that the Output voltage varies while the VOLT encoder is rotated. The minimum control range is from zero to the maximum rated Output voltage for the power supply model.
- c) Compare the DVM reading with the front panel VOLT display to verify the accuracy of the VOLT display. Ensure that the front panel VOLT LED is On.
- d) Press the front panel AC ON/OFF power switch to the Off position.

#### 3.8.4. Constant Current Check

- a) Ensure that the front panel AC ON/OFF switch is set to the Off position and the DVM connected to the output terminals shows zero Output voltage.
- b) Connect a DC shunt across the output terminals. Ensure that the shunt and the wire voltage and current ratings are higher than the Power Supply Output voltage and Output current ratings. Connect a DVM across the shunt.

- c) Press the front panel AC ON/OFF switch to the On position.
- d) Turn On the output by pressing the OUT pushbutton (the front panel OUT LED should illuminate).
- e) Observe the Power Supply CURRENT display and rotate the CURRENT encoder. Ensure that the Output current varies while the CURRENT encoder is rotated. The minimum control range is from zero to the maximum rated Output current for the Power Supply model. Compare the DVM reading with the front panel CURRENT display to verify the accuracy of the CURRENT display. Ensure that the front panel CURRENT LED is on.
- f) Press the front panel AC ON/OFF switch to the Off position.
- g) Remove the DVM and shunt from across the Power Supply output terminals.

### 3.8.5. OVP Check

Refer to Section 5.3 for explanation of the OVP function prior to performing the procedure below.

- a) Press the front panel AC ON/OFF power switch to the On position and turn on the output by pressing the front panel OUT pushbutton.
- b) Using the VOLT encoder, adjust the Output voltage to approximately 10% of the unit Output voltage rating.
- c) Momentarily press the OVP/UVL button so that the CURRENT display shows "OUP". The VOLTAGE display will also show the last setting of the OVP level.
- d) Rotate the VOLT encoder CCW to adjust the OVP setting to 50% of the unit Output voltage rating.
- e) Wait a few seconds until the VOLT display returns to show the actual Output voltage.
- f) Adjust the Output voltage toward its maximum and check that the Output voltage cannot be increased more than OVP setting of Step d).
- g) Adjust the OVP limit to the maximum value by repeating Step c) and rotating the VOLT encoder clockwise (CW).

### 3.8.6. UVL Check

Refer to Section 5.4 for explanation of the UVL function prior to performing the procedure below.

- a) Press the OVP/UVL button TWICE so that the CURRENT display shows "UUL". The VOLTAGE display will also show the last setting of the UVL level.
- b) Rotate the VOLT encoder clockwise (CW) to adjust the UVL level to approximately 10% of the unit Output voltage rating.
- c) Wait a few seconds until the VOLT display returns to show the actual Output voltage.
- d) Adjust the Output voltage toward its minimum value and check that the Output voltage cannot be decreased below the UVL setting of Step b).
- e) Adjust the UVL limit to its minimum value by repeating Step a) and rotating the VOLT encoder counterclockwise (CCW).

### 3.8.7. Foldback Check

	<p><b>WARNING</b></p> <p>Shorting the Output Positive and Negative connections together may expose the user to hazardous voltages. Observe proper safety procedures.</p>
---	--

Refer to Section 5.5 for explanation of the FOLD function prior to performing the procedure below.

- a) Connect a variable load across the unit output that ranges from 5-15% of rated Output current. Set the load current to 5% of rated Output current.
- b) Ensure that the Output voltage is set to approximately 10% of the unit Output voltage rating.
- c) Adjust the CURRENT encoder to set the current limit to approximately 10% of the unit Output current rating.
- d) Momentarily press the FOLD button. Ensure that the FOLD LED illuminates. The Output voltage should remain unchanged.
- e) Increase the load current from 5% to 15% of rated Output current. Ensure that the Output voltage falls to zero, the VOLT display shows “Fb” and the ALARM LED blinks.
- f) Press the FOLD button again to cancel the Foldback protection. The Output voltage should remain at zero.
- g) Press the OUT button. Ensure that the Output voltage returns to its last setting.
- h) Turn the output Off by pressing the OUT button. The VOLT display should display “OFF”.

### 3.8.8. Address Setting

- a) Press and hold the REM/LOC button for approximately 3 seconds. The VOLT display will show the communication port Address.
- b) Using the VOLT adjust encoder, set the unit Address within the range of 0 to 30.
- c) Set the unit Address back to the factory default setting (see Section 8.2.1).

### 3.8.9. Baud Rate Setting (RS-232 and RS-485 only)

- a) Press and hold the REM/LOC button for approximately 3 seconds. The CURRENT display will show the communication port Baud rate.
- b) Using The CURRENT adjust encoder, set the Baud rate to 1200, 2400, 4800, 9600 or 19200.
- c) Set the unit Baud rate back to the factory default setting (see Section 8.2.1).

## 3.9. Connecting the Load



### WARNING

Turn Off the AC input power before making or changing any rear panel connection. Ensure all live circuits are discharged and that all connections are securely tightened before applying power.

### 3.9.1. Load Wiring

The following considerations should be made to select wiring for connecting the load to the Power Supply:

- Current carrying capacity of the wire (refer to Section 3.9.2).
- Insulation rating of the wire should be at least equivalent to the maximum Output voltage of the Power Supply
- Maximum wire length and voltage drop (design for 1V drop per lead).
- Noise and impedance effects of the load wire (refer to Section 3.9.4).

### 3.9.2. Current Carrying Capacity

The load cables between the Power Supply Output and the load must be specified. The cable connections must be secured to required torque spec. Failure to meet

these requirements could cause substantial voltage-drop power losses, terminal over-heating, and insulation degradation.

The Output styles vary depending on the Output voltage range:

- Platform A & B (Output Voltage Range: 7.5V-80V & 100V-300V).
  - Vertical Bus Bar Configuration
  - 0.422 inch mounting hole
    - 7.5V-25V models have two mounting holes
    - 30V-300V models have one mounting hole
  - Use 3/8 inch diameter bolt/nut.
- Platform C (Output voltage range: 400V- 600V)
  - Threaded-stud configuration
  - M6 x1.0inch nut/washer size

The Output connections are protected with a metal cover. To connect the load cables, remove the metal cover and connect the proper size cables with nuts and bolts.

Proper torque (as per bolt size) should be applied to any bolt/nut combination.

Typical cable sizes for load connections are shown below. Use cables that meet requirements for current, voltage, length, temperature and termination.

<b>CURRENT (Amps) <math>I_o</math></b>	<b>RECOMMENDED COPPER WIRE SIZE</b>
$I_o \leq 50$	6 AWG.
$50 < I_o \leq 100$	0 AWG.
$100 < I_o \leq 187.5$	1 x 0000 AWG.
$187.5 < I_o \leq 333$	2 x 0000 AWG.
$333 < I_o \leq 700$	3 x 0000 AWG.
$700 < I_o \leq 1000$	4 x 0000 AWG.

**Table 3-2: Recommended Cable Size for Output Connection**

### 3.9.3. Load Cable Termination

The load cables should be properly terminated with terminals securely attached. DO NOT use un-terminated wires for any load connections at the Power Supply.

**CAUTION**

Be careful when connecting the remote sense lines to the far end of the load cables. Reversing the sense line polarity to the load, or leaving the +S or -S sense lines opened, could damage the Power Supply.  
See Section 3.10.3 for more information.

### 3.9.4. Noise and Impedance Effects

To minimize any noise pickup or radiated noise, the load wires and remote sense wires should be twisted pairs to the shortest possible length. Shielding of sense leads may be necessary in high noise environments. Where shielding is used, connect the shield to the chassis via a rear panel Ground screw. Even if noise is not a concern, the load and remote sense wires should be twisted-pairs to reduce coupling, which might impact the stability of the Power Supply. The sense leads should be separated from the power leads.

Twisting the load wires reduces the parasitic inductance of the cable, which could produce high frequency voltage spikes at the load and the Output of the Power Supply (because of current variation in the load itself).

The impedance introduced between the Power Supply output and the load could make the ripple and noise at the load worse than the noise at the power supply rear panel output. Additional filtering with bypass capacitors at the load terminals may be required to bypass the high frequency load current.

### 3.9.5. Inductive Loads

Inductive loads can produce voltage spikes that may be harmful to the Power Supply. A diode should be connected across the output. The diode voltage and current rating should be greater than the Power Supply maximum Output voltage and Output current rating. Connect the cathode of the diode to the positive output and the anode of the diode to the negative output of the Power Supply.

Where positive load transients such as back EMF from a motor may occur, connect a surge suppressor across the output to protect the Power Supply. The breakdown voltage rating of the suppressor must be approximately 10% higher than the maximum Output voltage of the Power Supply.



#### WARNING

Hazardous voltages may exist at the outputs and the load connections when using a power supply of any rated Output Voltage. To protect personnel against accidental contact with hazardous voltages, ensure that the load and its connections have no accessible and live parts. Ensure that the load wiring insulation rating is greater than or equal to the maximum Output voltage of the power supply.

#### CAUTION

Ensure that the load wiring mounting hardware does not short-circuit the output terminals. Heavy load cables must have some form of strain relief to prevent loosening of the connections or bending of the busbars.

### 3.9.6. Connecting Single Loads, Local Sensing (Default).

Fig.3-3 shows recommended load and sensing connections for a single load. The local sense lines shown are default connections at the rear panel J2 sense connector. Local sensing is suitable for applications where load regulation is less critical.

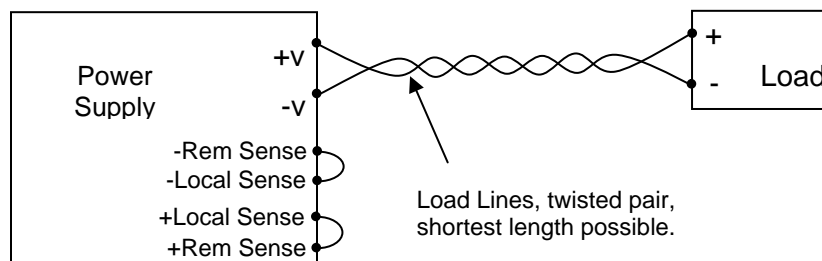

**Fig. 3-3: Single load connection, local sensing**

**3.9.7. Connecting Single Loads, Remote Sensing**

Fig.3-4 shows the recommended remote sensing connection for single loads. Remote sensing is used when, in Constant-Voltage mode, the load regulation is important at the load terminals. Use twisted or shielded wires to minimize any noise pick-up. If shielded wires are used, the shield should be connected to the ground at one point, either at the Power Supply chassis or the load ground. The optimal point for the shield ground should be determined by experimentation.

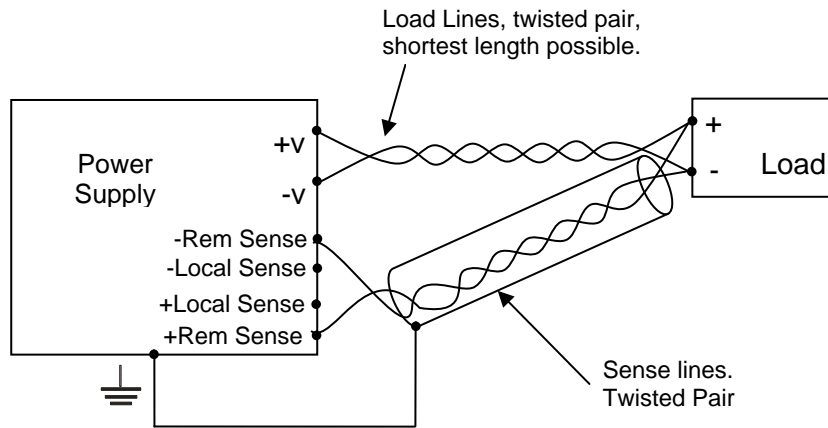

**Fig. 3-4: Remote sensing, single load**

**3.9.8. Connecting Multiple Loads, Radial Distribution Method**

Figure 3-5 shows multiple loads connected to one Power Supply. Each load should be connected to the power supply's output terminals using separate pairs of wires. It is recommended that each pair of wires will be as short as possible and twisted or shielded to minimize noise pick-up and radiated noise. The sense wires should be connected to the Power Supply Output busbars/threaded-studs or to the load with the most critical load regulation requirement.

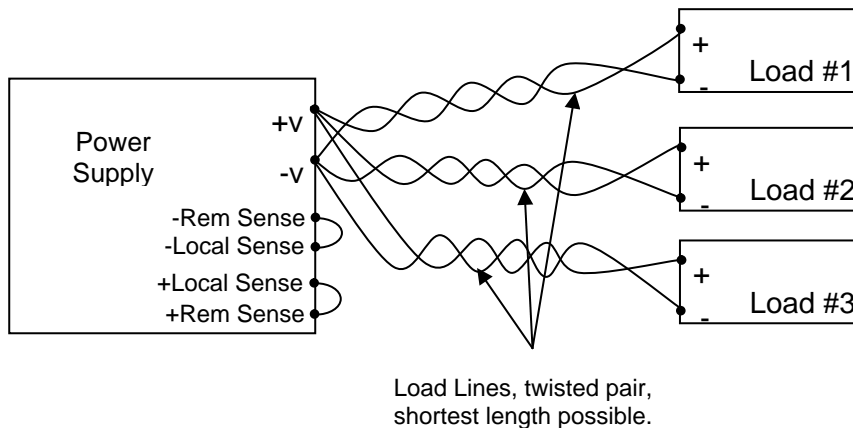

**Fig. 3-5: Multiple loads connection, radial distribution, local sense**



### 3.9.9. Multiple Load Connection with Distribution Terminals

If remotely located output distribution terminals are used, the Power Supply output terminals should be connected to the distribution terminals by a pair of twisted and/or shielded wires. Each load should be separately connected to the remote distribution terminals (see Fig.3-6).

If remote sensing is required, the sensing wires should be connected to the distribution terminals or at the most critical load.

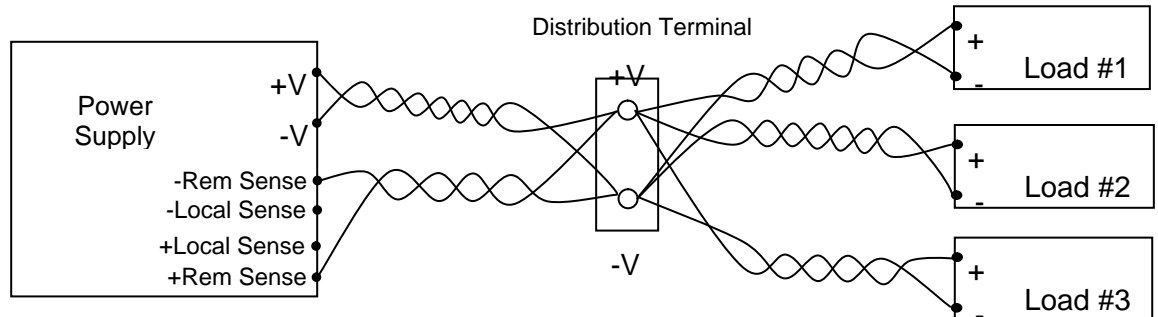

Fig. 3-6: Multiple loads connection with distribution terminal

### 3.9.10. Grounding Outputs

Either the positive or negative output terminals can be grounded. To avoid noise problems caused by common-mode current flowing from the load to ground, it is recommended to ground the output terminal as close as possible to the Power Supply chassis ground.

Always use two wires to connect the load to the Power Supply regardless of how the system is grounded.



#### WARNING

All models shall not float outputs more than +/- 600VDC above/below chassis ground.



#### WARNING

##### OUTPUT TERMINAL GROUNDING

There is a potential shock hazard at the RS-232/RS-485, IEEE port and LAN port when using power supplies with rated or combined voltage greater than 400V with the Positive Output of the power supplies grounded. **Do not** connect the Positive Output to ground when using the RS-232/RS-485, IEEE or LAN interfaces under the above conditions.

### 3.10. Local and Remote Sensing

The rear panel J2 sense connector is used to configure the Power Supply for local or remote sensing of the Output voltage. Refer to Fig. 3-7 for sense connector location.

### 3.10.1. Sense Wiring



**WARNING**

There is a potential shock hazard at the sense connector. Local sense and remote sense wires should have a minimum insulation rating equivalent or greater than the maximum Output voltage of the Power Supply. Ensure that the connections at the load end are shielded to prevent accidental contact with hazardous voltages.

### 3.10.2. Local Sensing

The Power Supply is shipped with the rear panel J2 sense connector wired for local sensing of the Output voltage. See Table 3-4 for J2 terminals assignment. With local sensing, the Output voltage regulation is made at the output terminals. This method does not compensate for voltage drop on the load wires, therefore it is recommended only for low load current applications or where the load regulation is less critical.

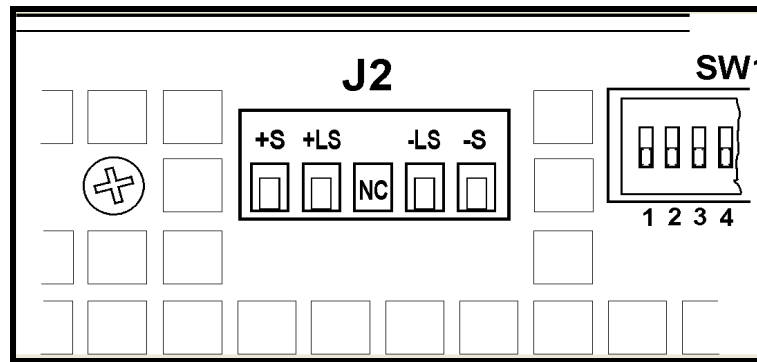

**Fig. 3-7: Sense Connector Location**

Terminal	Function
J2-1	Remote positive sense (+S)
J2-2	Local positive sense. Connected internally to the positive output terminal (+LS).
J2-3	Not connected (NC)
J2-4	Local negative sense. Connected internally to the negative output terminal (-LS).
J2-5	Remote negative sense (-S).

**Table 3-3: J2 Terminals**

### 3.10.3. Remote Sensing



#### WARNING

There is a potential shock hazard at the J2 sense connector. Ensure that the connections at the load end are shielded to prevent accidental contact with hazardous voltages.

#### CAUTION

When using shielded sense wires, the shield should be grounded in only one location. The location can be the Power Supply chassis or one of the output terminals

Use remote sense where the load regulation at the load end is critical. In remote sense, the Power Supply will compensate for the voltage drop across the load wires. Refer to the Power Supply specifications of Section 2 for the maximum voltage drop across the load wires. The voltage drop is subtracted from the total voltage available at the output. Follow the instructions below to configure the Power Supply for remote sensing:

- a) Ensure that the front panel AC On/Off switch is in the Off position.
- b) Remove the local sense jumpers from J2.
- c) Connect the negative sense lead to terminal J2-5 (-S) and the positive sense lead to terminal J2-1(+S) of the J2 mating connector. Ensure that the J2 mating connector is plugged securely into the rear panel sense connector, J2.
- d) Press the front panel AC On/Off power switch to the On position.

#### NOTES:

1. *If the power supply is operating in remote sense and either the positive or negative load wire is not connected, an internal protection circuit will activate and shut down the Power Supply. To resume operation, turn the power supply Off using the AC ON/OFF switch. Then re-connect the open load wire, turn the power supply On using the AC ON/OFF switch and press the front panel OUT button.*
2. *If the Power Supply is operated without the remote sense lines or local sense jumpers, it will continue to work, but the Output voltage regulation will be degraded. Also, the OVP circuit may activate and shut down the Power Supply.*

### 3.10.4. J2 Sense Connector Technical Information

- J2 connector type: MC 1.5/5-G-3.81, Phoenix.
- Plug type: MC 1.5/5-ST-3.81, Phoenix.
- Wire AWG; 28 up to 16. (use wire with insulation rating equal to or greater than the power supply Output voltage rating).
- Stripping length: 7mm (0.28 inches).
- Tightening torque: 0.22-0.25Nm (1.95-2.21Lb-Inch.)

### 3.11. Repackaging for Shipment

To ensure safe transportation of the instrument, contact the TDK-Lambda Americas Inc. Sales or Service facility near you for Return Authorization and shipping information. Please attach a tag to the power supply describing the problem and specifying the owner, model number and serial number of the Power Supply. Refer to Warranty Information for further instructions.

## 4. FRONT AND REAR PANEL CONTROLS AND CONNECTORS

### 4.1. Introduction

The Genesys™ Power Supply series has a full set of controls, indicators and connectors that allow the user to easily setup and operate the unit. Before starting to operate the unit, please read the following sections for explanation of the functions of the controls and connectors terminals:

- Section 4.2: Front Panel Controls and Indicators.
- Section 4.3: Rear Panel Connections and Controls.

### 4.2. Front Panel Controls and Indicators

See Figure 4-1 to review the controls, indicators and meters located on the Power Supply front panel.

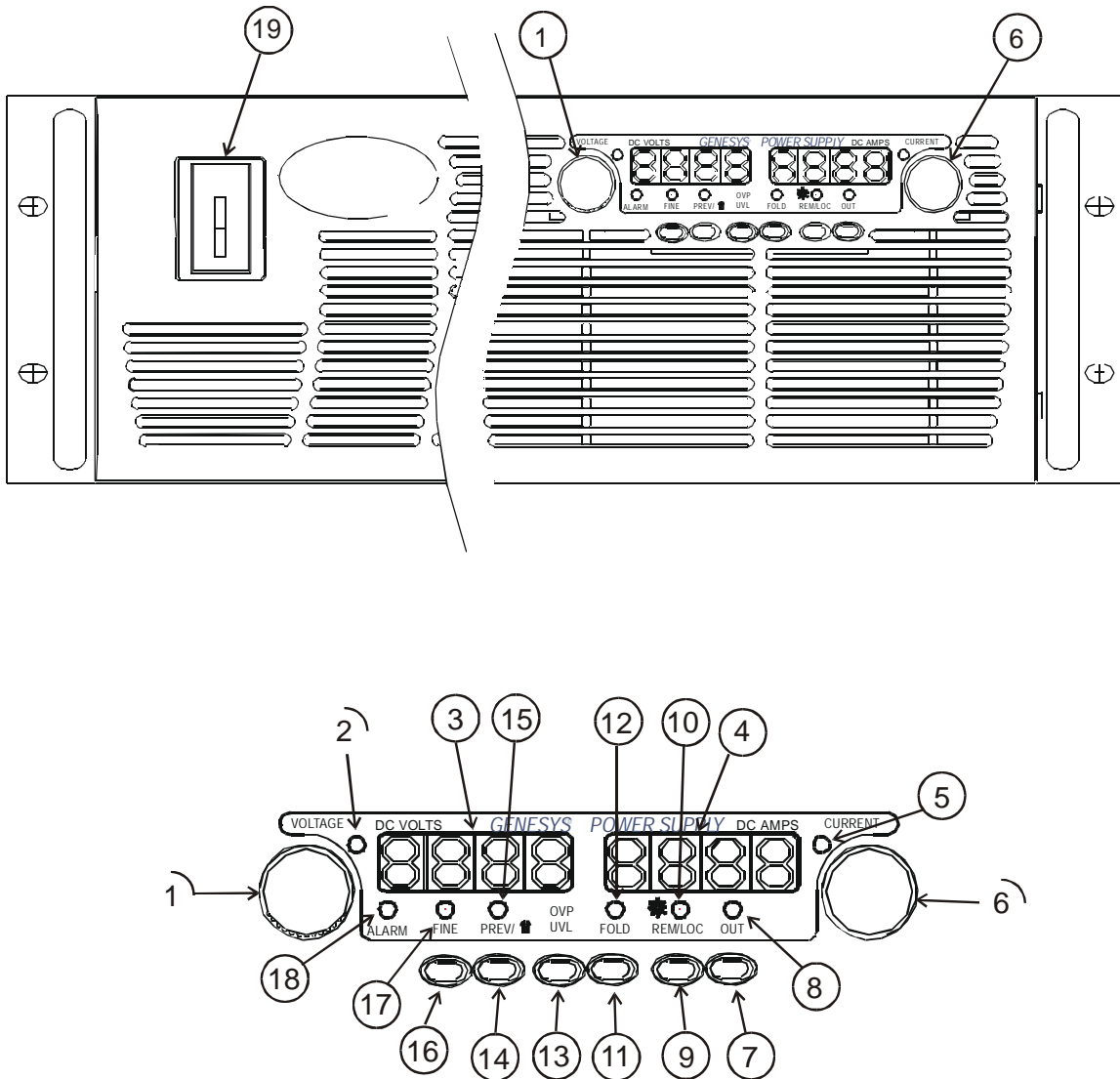

Fig. 4-1: Front Panel Controls and Indicators.

**Table 4-1: Front Panel Controls and Indicators**

Number	Control/Indicator	Description	Section
1	VOLTAGE control	High resolution rotary encoder for adjusting the Output voltage. Also adjusts the OVP/UVL levels and selects the Address	5.2.1 5.3.1 5.4.1 8.2.2
2	VOLTAGE indicator	Green LED, lights for Constant-Voltage mode operation.	
3	VOLTAGE display	4 digit, 7-segment LED display. Normally displays the Output voltage. When the PREV button is pressed, the display indicates the programmed setting of the Output voltage. When the OVP/UVL button is pressed, the VOLTAGE display indicates the OVP/UVL setting.	
4	CURRENT display	4 digit, 7 segment LED display. Normally displays the Output current. When the PREV button is pressed, the display indicates the programmed setting of Output current.	
5	CURRENT indicator	Green LED, lights for Constant-Current mode operation	
6	CURRENT control	High resolution rotary encoder for adjusting the Output current. Also selects the Baud rate of the communication port.	5.2.2 8.2.4
7	OUT button	<b>Main function:</b> Output ON/OFF control. Press OUT to set the output On or Off. Press to reset and turn On the output after OVP or FOLD alarm events have occurred. <b>Auxiliary function:</b> Selects between "Safe-Start" and "Auto-Restart" modes. Press and hold OUT button to toggle between "Safe-Start" and "Auto-Restart". The VOLT display will cycle between "SAF" and "AUT". Releasing the OUT button while one of the modes is displayed, selects that mode.	5.6 5.11
8	OUT indicator	Green LED, lights when the DC output is enabled.	
9	REM/LOC button	<b>Main function:</b> Go to Local mode. Press REM/LOC to put the unit into Local (REM/LOC button is disabled at Local Lockout mode). <b>Auxiliary function:</b> Address and Baud rate setting. Press and hold REM/LOC for 3 sec. to set the unit Address with the VOLTAGE encoder and the unit Baud rate with the CURRENT encoder.	8.2.5 8.2.2 8.2.4
10	REM/LOC indicator	Green LED, lights when the unit is in Remote mode.	
11	FOLD button	Foldback protection control. -Press FOLD to set Foldback protection to On. -To release Foldback alarm event, press OUT to enable the output and re-arm the Foldback protection. -Press FOLD again to cancel the Foldback protection.	5.5
12	FOLD indicator	Green LED, lights when Foldback protection is On.	

**Table 4-1: Front Panel Controls and Indicators (Cont.)**

Number	Control/Indicator	Description	Section
13	OVP/UVL button	Over Voltage Protection and Under Voltage limit setting. -Press once to set OVP using the VOLTAGE encoder (the current display shows "OUP") -Press again to set the UVL using the VOLTAGE encoder (the current display shows "UUL").	5.3 5.4
14	PREV button	<b>Main function:</b> Press PREV to display the Output voltage and current limit setting. For 5 seconds the display will show the setting and then it will return to show the actual Output voltage and current. <b>Auxiliary function:</b> Front Panel Lock. Press and hold PREV button to toggle between "Locked front panel" and "Unlocked front panel". The display will cycle between "LFP" and "UFP". Releasing the PREV button while one of the modes is displayed selects that mode.	5.12
15	PREV indicator	Green LED, lights when PREV button is pressed	
16	FINE button	<b>Main function:</b> Voltage and Current Fine/Coarse adjustment control. Operates as a toggle switch. In Fine mode, the VOLTAGE and CURRENT encoders operate with high resolution and in Coarse mode with lower resolution (approx. 6 turns). <b>Auxiliary function:</b> Advanced Parallel Operation Mode Setting.	6.4
17	FINE indicator	Green LED, lights when the unit is in Fine mode.	
18	ALARM indicator	Red LED, blinks in case of fault detection. OVP, OTP, Foldback, Enable and AC fail detection will cause the ALARM LED to blink.	
19	AC Power Switch	AC ON/OFF Control	

### 4.3. Rear Panel Connections and Controls

See Fig. 4-2 to review the connections and controls located on the Power Supply rear panel. Refer to Table 4-2 for explanations about the rear panel connections and controls.

**10kW Platform A Output Range: 7.5V-25V**

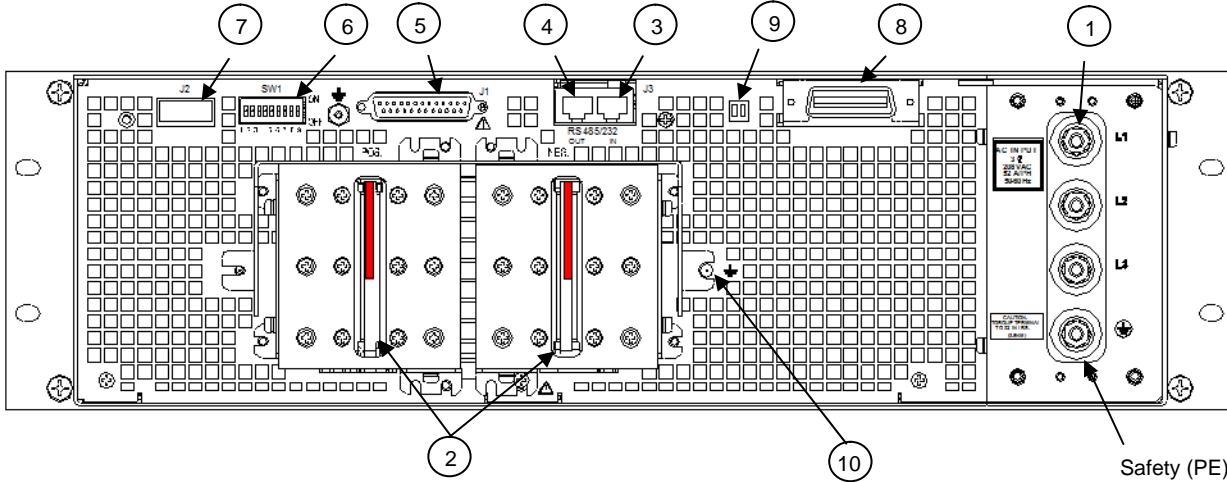

Safety (PE)  
GND must be connected.

**10kW/15kW Platform A & B Output Range: 30V-300V**

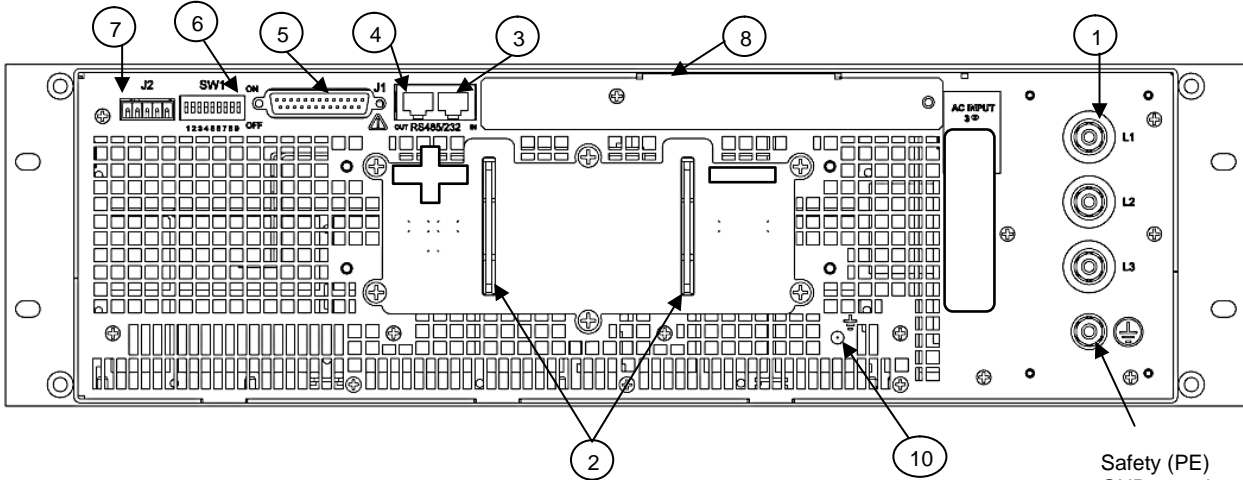

Safety (PE)  
GND must be connected.

**10kW/15kW Platform C Output Range: 400V-600V**

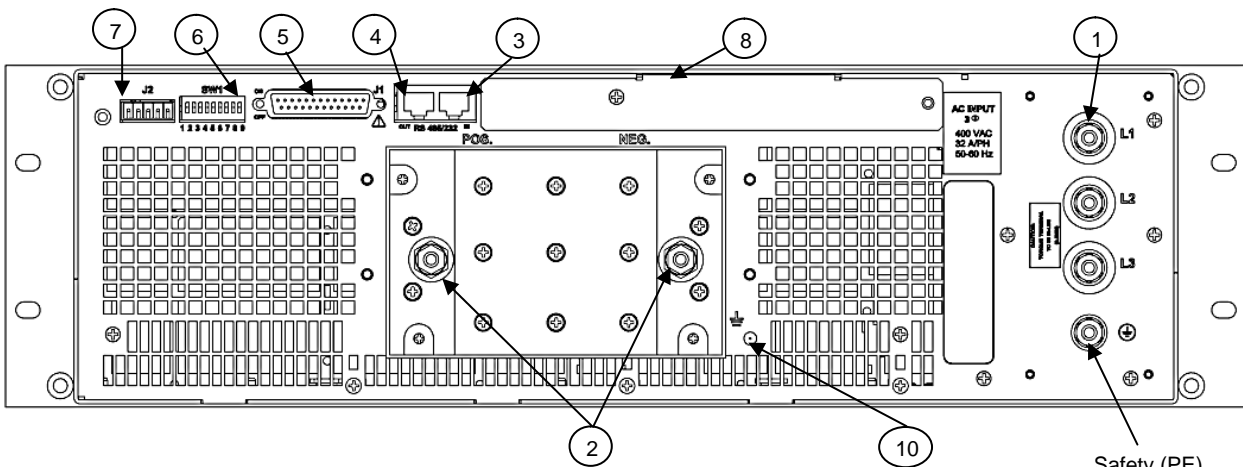

Safety (PE)  
GND must be connected.

**Figure 4-2: Rear Panel Connections and Switches**

**Table 4-2: Rear Panel Connections and Controls**

Number	Item	Description	Section
1	AC input	M6x10mm Stud terminal suitable for ring lugs.	3.7
2	DC output	Bus-bars ( $7.5V \leq V_{out} \leq 300V$ models). M6x10mm threaded-stud terminals ( $300V < V_{out} < 600V$ models).	3.9 3.9.1
3	Remote-In connector	RJ-45 type connector, use for connecting power supplies to RS-232 or RS-485 port of computer for remote control purposes. When using several power supplies in a power system, the first unit Remote-In is connected to the computer and the remaining units are daisy-chained, Remote-In to Remote-Out.	8.3 8.4
4	Remote Out connector	RJ-45 type connector, used for daisy-chaining power supplies to form a serial communication bus.	8.3 8.4
5	J1 Analog Remote Program and Monitor connector	Connector for remote analog interface. Includes Output voltage and current programming and monitoring signals, Shut-off control (electrical signal), Enable/Disable control (dry-contact), Power Supply OK (PS_OK) signal and operation mode (CV/CC) signal.	4.5 4.4.1
6	SW1 Setup switch	Nine position DIP-switch for selecting remote programming and monitoring modes for Output Voltage, Current Limit and other control functions.	4.4 4.4.1 4.4.2
7	J2 Remote sense connector	Connector for making remote sensing connections to the load for regulation of the load voltage and compensation of load wire drop.	3.8.2 3.10.2 3.10.3
8	Blank or Option Plate	Blank sub-plate for standard units. Other plates and connectors for options such as LAN, IEMD or Isolated Analog. IEEE connector for units equipped with IEEE programming option (shown).	Fig. 4-2
9	IEEE switch LAN switch	Two position DIP-switch for selecting option mode or RS-232/RS-485 mode. The options may be LAN or IEEE.	Fig. 4-2
10	Ground screw	M5 x 20mm screw for Chassis ground connection.	Fig. 4-2



#### 4.4. Rear Panel SW1 Setup Switch

The SW1 Setup switch (see Fig.4-3) is a 9-position DIP-switch that allows the user to choose the following:

- Internal or remote programming of Output voltage and Output current.
- Remote voltage or resistive programming of Output voltage and Output current.
- Select range of remote voltage and resistive programming.
- Select range of Output voltage and Output current monitoring.
- Select the Remote Shut-Off control logic.
- Select between RS-232 and RS-485 communication interface.
- Enable or Disable the rear panel Enable/Disable control (dry-contact).

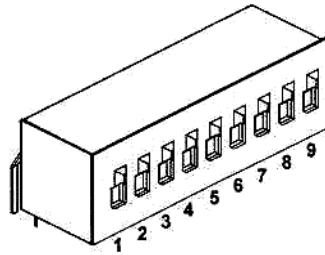

**Fig. 4-3: SW1 setup DIP-switch**

##### 4.4.1. SW1 Position Function

Refer to Table 4-3 for description of SW1 position functions. The factory default setting is Down for all positions.

**Table 4-3: SW1 Positions Functions**

Position	Function	DOWN (Factory default)	UP
SW1-1	Output Voltage Remote Analog Programming	Output Voltage Programmed by Front Panel	Output Voltage Programmed by remote analog External Voltage
SW1-2	Output Current Remote Analog Programming	Output Current programmed by Front Panel	Output Current programmed by remote analog External Voltage
SW1-3	Programming Range Select (Remote voltage/resistive)	0-5V (0-5kohm)	0-10V (0-10kohm)
SW1-4	Output Voltage and Current Monitoring Range	0-5V	0-10V
SW1-5	Shut-Off Logic select	Off: Low (0-0.6V) or Short On: High (2-15V) or Open	Off: High (2-15V) or Open On: Low (0-0.6V) or Short
SW1-6	RS-232/RS-485 select	RS-232 interface	RS-485 interface
SW1-7	Output Voltage Resistive Programming	Output Voltage programmed by Front Panel	Output Voltage programmed by External resistor
SW1-8	Output Current Resistive Programming	Output Current programmed by Front Panel	Output Current programmed by External resistor
SW1-9	Enable/Disable control	Rear panel Enable/Disable control is not Active	Rear panel Enable/Disable control is Active

#### 4.4.2. Resetting the SW1 switch

Before making any changes to the SW1 switch setting, disable the Power Supply output by pressing the front panel OUT button. Ensure that the Output voltage falls to zero and the OUT LED is Off. Then use any small flat-bladed screwdriver to change the SW1 switch setting.

#### 4.5. Rear Panel J1 Programming and Monitoring Connector

The J1 Remote Analog Programming and Monitoring connector is a DB25 subminiature connector located on the Power Supply rear panel. Refer to Table 4-4 for a description of the connector functions. The power supply default configuration is Local operation, which does not require connections to J1. For Remote Analog operation using J1 signals, use the plug provided with the Power Supply (or equivalent type). It is essential to use a plastic body plug to conform to Safety Agency requirements. A shielded cable is required to maintain EMC Specifications for the J1 wires. Connect the shield to a Power Supply Chassis ground screw.

##### 4.5.1. Making J1 Connections

- J1 connector type: AMP, P/N: 747461-3
- J1 plug description: AMP, P/N: 745211-7 or -8
- Wire dimension range: AWG26-22
- Extraction tool: AMP, 91232-1 or equivalent.
- Manual Pistol grip tool:
  - Handle: AMP, P/N: 58074-1
  - Head: AMP, P/N: 58063-2

Before making any connection, turn the AC On/Off switch to the Off position, wait until the front panel display has turned Off and wait until the Output voltage has dropped to zero.

#### CAUTION

Connector pins J2-12, -22 and -23 are connected internally to the negative local sense (-LS) potential of the Power Supply. Do not attempt to bias any of these terminals relative to the negative local sense.

Use the Isolated Analog interface to allow control from a programming source at a different potential than the Power Supply negative output.

To prevent ground loops and to maintain the isolation of the Power Supply when programming from J1, use an ungrounded programming source.



#### WARNING

There is a potential shock hazard at the Power Supply output. Use wires with minimum insulation rating equivalent to the maximum Output voltage of the Power Supply.

Fig.4-4: J1 connector terminals and functions

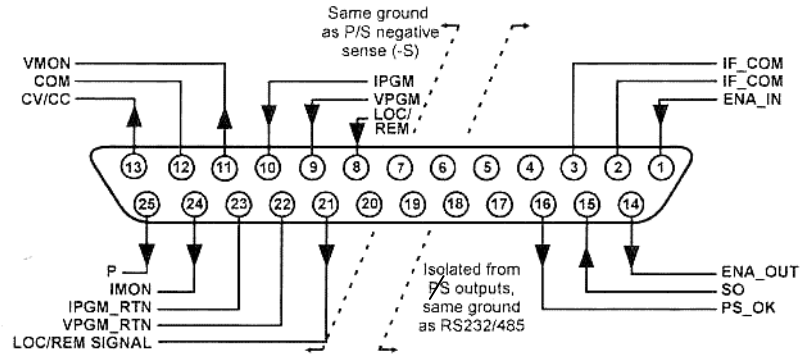

Table 4-4: J1 Connector Terminals and Functions

J1 contact	Signal name	Function	Section
J1-1	ENA_IN	Enable/Disable the Power Supply output by dry-contact (short/open) with ENA_OUT.	5.8
J1-2 J1-3	IF_COM	Isolated Interface Common. Return for the SO control, PS_OK signal and for the optional IEEE interface.	5.7 5.10
J1-4~7	N/C	No Connection	
J1-8	LOCAL/ REMOTE	Input for selecting between Local or Remote analog programming of Output voltage and Output current.	7.2
J1-9	VPGM	Input for remote analog voltage/resistance programming of the Output voltage.	7.1, 7.4
J1-10	IPGM	Input for remote analog voltage/resistance programming of the Output current.	7.1, 7.4
J1-11	VMON	Output for monitoring the Power Supply Output voltage.	7.6
J1-12	COM	Control Common. Return for VMON, IMON, CV/CC, LOC/REM. Connected internally to the negative local sense (-LS) potential.	
J1-13	CV/CC	Output for Constant-Voltage/Constant-Current mode indication.	5.9
J1-14	ENA_OUT	Enable/Disable the power supply output by dry-contact (short/open) with ENA_IN.	5.8
J1-15	SO	Input for Shut-Off control of the power supply output.	5.7
J1-16	PS_OK	Output for indication of the power supply status.	5.10
J1-17~20	N/C	No Connection.	
J1-21	LOC/REM SIGNAL	Output for indicating if the unit is in Local or Remote analog programming mode.	7.3
J1-22	VPGM_RTN	Return for VPGM input. Connected internally to the "-LS" potential.	7.1 7.4 7.5
J1-23	IPGM_RTN	Return for IPGM input. Connected internally to the "-LS" potential.	7.1 7.4 7.5
J1-24	IMON	Output for monitoring the Power Supply Output current.	7.6
J1-25	P	Output for current balance in parallel operation.	6.2

## 5. LOCAL OPERATION

---

### 5.1. Introduction

This Chapter describes the operating modes that are not involved in programming and monitoring the Power Supply via its serial communication port (RS-232/RS-485) or by Remote Analog signals. Ensure that the REM/LOC LED on the front panel is Off, indicating Local mode. If the REM/LOC LED is On, press the front panel REM/LOC button to change the operating mode to Local.

- For information regarding Remote Analog Programming, refer to Chapter 7.
- For information regarding usage of the serial communication port, refer to Chapter 8.

### 5.2. Standard Operation

The Power Supply has two basic operating modes: Constant-Voltage mode and Constant-Current mode. The mode in which the Power Supply operates at any given time depends on the Output voltage setting, Output current limit setting and the load resistance.

#### 5.2.1. Constant Voltage Mode

- In Constant-Voltage mode, the power supply regulates the Output voltage at the selected value, while the load current varies as required by the load.
- While the Power Supply operates in Constant-Voltage mode, the VOLTAGE LED on the front panel is illuminated.
- Adjustment of the Output voltage can be made when the Power Supply output is Enabled (Output On) or Disabled (Output Off). When the output is enabled, simply rotate the VOLTAGE encoder knob to program the Output voltage. When the output is disabled, press the PREV button and then rotate the VOLTAGE encoder knob. The VOLTAGE meter will show the programmed Output voltage for 5 seconds after the adjustment has been completed. Then the VOLTAGE meter will display “OFF”.
- Adjustment resolution can be set to coarse or fine resolution. Press the FINE button to select between the lower and higher resolution. The FINE LED turns On when the resolution is set to FINE.

**NOTE**

If after completing the adjustment, the display shows a different value than the setting, the Power Supply may be at current limit. Check the load condition and the Power Supply current limit setting.

**NOTE**

The maximum and minimum setting values of the Output voltage are limited by the Over Voltage protection and Under Voltage limit setting. Refer to Sections 5.3 and 5.4 for more details.

### 5.2.2. Constant Current Mode

- a) In Constant-Current mode, the Power Supply regulates the Output current at the selected value, while the voltage varies with the load requirement.
- b) While the Power Supply is operating in Constant-Current mode, the CURRENT LED on the front panel is illuminated.
- c) Adjustment of the Output current can be made when the power supply output is enabled (Output On) or disabled (Output Off).
  - Disabled Output (Off): Press the PREV button and then rotate the Current encoder knob. The CURRENT meter will show the programmed current for 5 seconds after the adjustment has been completed. Then the VOLTAGE meter will display “OFF”.
  - Enabled Output (On) with Power Supply in Constant-Voltage mode: Press the PREV button and then rotate the CURRENT encoder knob. The CURRENT meter will show the programmed current limit for 5 seconds after the adjustment has been completed, and will then return to show the actual Output current.
  - Enabled Output with Power Supply in Constant-Current mode: Rotate the CURRENT encoder knob to adjust the current limit.
- d) Adjustment resolution can be set to Coarse or Fine adjustment. Press the FINE button to select between Coarse and Fine resolution. The FINE LED turns On when the resolution is set to FINE.

### 5.2.3. Automatic Crossover

If the Power Supply operates in Constant-Voltage mode, while the load current is increased to greater than the Output current limit setting, the Power Supply will automatically switch to Constant-Current mode. If the load is decreased to less than the Output current limit setting, the power supply will automatically switch back to Constant-Voltage mode.

## 5.3. Over Voltage Protection (OVP)

The OVP circuit protects the load in the event of a remote or local programming error or a Power Supply failure. The protection circuit monitors the voltage at the power supply sense points thus providing the protection level at the load. Upon detection of an Over-Voltage condition, the power supply output will shut down.

### 5.3.1. Setting the OVP Level

The OVP can be set when the Power Supply output is Enabled (On) or Disabled (Off). To set the OVP level, press the OVP/UVL button, so that the CURRENT meter shows “OUP”. The VOLTAGE meter shows the OVP setting level. Rotate the VOLTAGE encoder knob to adjust the OVP level. The display will show “OUP” and the setting value for 5 seconds after the adjustment has been completed and will then return to its previous state.

To preview the OVP setting, press the OVP/UVL pushbutton so that the CURRENT display will show “OUP”. At this time, the VOLTAGE display will show the OVP setting. After 5 seconds, the display will return to its previous state.

The minimum setting level is approximately 105% of the set Output voltage. The maximum setting levels are shown in Tables 8-8 and 8-11.

### 5.3.2. Activated OVP Protection Indications

When the OVP is activated the Power Supply output shuts down, the VOLTAGE display shows “OUP” and the ALARM LED blinks.

### 5.3.3. Resetting the OVP Circuit

To reset the OVP circuit after it activates:

- a) Reduce the Power Supply Output voltage setting below the OVP set point.
- b) Ensure that the load and the sense wiring are connected properly.
- c) There are four methods to reset the OVP circuit.
  - Press the OUT button.
  - Turn the Power Supply Off using the AC On/Off switch, wait until the front panel display turns Off, then turn the power supply On using the AC On/Off switch.
  - Turn the Power Supply output Off and then On using the SO control (refer to Section 5.7). In this method, the Power Supply should be set to Auto-Restart mode.
  - Send the “OUT 1” command via the RS-232/RS-485 communication port.

## 5.4. Under Voltage Limit (UVL)

The UVL prevents adjustment of the Output voltage below a specific limit. The combination of UVL and OVP functions, allow the user to create a protection window for sensitive load circuitry.

### 5.4.1. Setting the UVL Level

Setting the UVL can be made when the Power Supply output is Enabled (On) or Disabled (Off). To set the UVL level, press the OVP/UVL button TWICE, so that the CURRENT meter shows “UUL”. The VOLTAGE meter shows the UVL setting level. Rotate the VOLTAGE encoder knob to adjust the UVL level. The display will show ‘UUL” and the setting value for 5 seconds after the adjustment has been completed and will then return to its previous state.

UVL setting values are limited at the maximum level to approximately 5% below the Output voltage setting. Attempting to adjust the UVL above this limit will result in no response to the adjustment attempt. The minimum UVL setting is zero.

## 5.5. Foldback Protection

Foldback protection will shut down the Power Supply output if the load current exceeds the current limit setting level. This protection is useful when the load circuitry is sensitive to an over current condition.

### 5.5.1. Setting the Foldback Protection

To arm the Foldback protection, the FOLD button should be pressed so that the FOLD LED illuminates. In this condition, a transition from Constant-Voltage to Constant-Current mode will activate the Foldback protection. Activation of the Foldback protection disables the Power Supply output, causes the ALARM LED to blink and displays “Fb” on the VOLTAGE meter.

### 5.5.2. Resetting Activated Foldback Protection

There are four methods to reset an activated Foldback protection.

- a) Press the OUT button. The Power Supply output is enabled and the Output voltage and Output current will return to their last settings. In this method, the Foldback protection remains armed; therefore if the load current is higher than the Output current limit setting, the Foldback protection will be activated again.
- b) Press the FOLD button to cancel the Foldback protection. The Power Supply output will be disabled and the VOLTAGE display will show “OFF”. Press the OUT button to enable the Power Supply output.
- c) Turn the Power Supply output Off and then On using the SO control (Refer to Section 5.7). In this method the Foldback protection remains armed, therefore if the load current is higher than the Output current limit setting the Foldback protection will be activated again.
- d) Turn the Power Supply Off using the AC On/Off switch, wait until the front panel display turns Off, then turn the unit back ON again by pressing the AC On/Off switch to the On position. The Power Supply output is enabled and the Output voltage and Output current will return to their last setting. In this method, the Foldback protection remains armed. Therefore, if the load current is higher than the Output current limit setting, the Foldback protection will be activated again.

### 5.6. Output ON/OFF Control

The Output On/Off enables or disables the Power Supply output. Use this function to make adjustments to either the power supply or the load without shutting off the AC On/Off switch. The Output On/Off can be activated from the front panel using the OUT button or from the rear panel J1 connector. The OUT button can be pressed at any time to enable or disable the Power Supply output. When the output is disabled, the Output voltage and Output current fall to zero and the VOLTAGE display shows “OFF”.

### 5.7. Output SHUT-OFF (SO) Control via Rear Panel J1 Connector

Contacts J1-2, -3 and -15 (Fig.4-2, Item 5) serve as Output Shut-Off (SO) terminals. The SO terminals accept a 2.5V to 15V signal or Open-Short contact to Enable or Disable the Power Supply output. The SO function will be activated only when a transition from On to Off is detected after applying AC power to the unit (in Auto-Restart mode, the output will not be enabled after applying AC power; even if SO is at an Off level). After an On to Off transition is detected, the SO will enable or disable the Power Supply output according to the signal level or the short/open applied to J1. This function is useful for also connecting power supplies in a “Daisy-chain” (refer to Section 6.3). The SO control can also be used also to reset the OVP and Foldback Protection (refer to Section 5.3 and 5.5 for details).

When the unit is shut-off by a J1 signal, the VOLTAGE display will show “SO” to indicate the unit state. J1-15 is the SO signal input and J1-2, J1-3 (IF\_COM) are the signal return connections (connected internally). J1-2, -3 and -15 are optically isolated from the Power Supply output. The SO control logic can be selected by the rear panel SW1 Setup switch. Refer to Table 5-1 for SW1 setting and SO control logic.

SW1-5 setting	SO signal level J1-2(3), 15	Power supply output	Display
Down (default)	2-15V or Open 0-0.6V or Short	On Off	Voltage/Current “SO”
Up	2-15V or Open 0-0.6V or Short	Off On	“SO” Voltage/Current

**Table 5-1: SO Logic Selection**

**5.8. Enable/Disable Control via Rear Panel J1 Connector**

J1-1 and J1-14 (Fig.4-4) serve as the Output Enable/Disable terminals by switch or relay. This function is enabled or disabled by SW1-9. Refer to Table 5-2 for the Enable/Disable function and SW1 settings.

SW1-9 setting	Enable/Disable inputs	Power supply output	Display	ALARM LED
Down (Default)	Open or Short	On	Voltage/Current	Off
Up	Open	Off	"ENA"	Blinking
	Short	On	Voltage/Current	Off

**Table 5-2: Enable/Disable function and SW1 setting**

**CAUTION**

To prevent possible damage to the unit, **DO NOT** connect any of the Enable/Disable inputs to the positive or negative output potential.

If the Enable/Disable inputs are opened when the unit is in Safe-Start mode, it is required to short the Enable/Disable inputs and then press the OUT button or send the "OUT 1" command to resume operation.

If the Enable/Disable inputs are opened when the unit is in Auto-Restart mode, it is required to short the Enable/Disable inputs and then the output will turn **NOTE** back ON automatically.

**5.9. CV/CC Signal**

The CV/CC signal indicates the operating mode of the Power Supply, Constant-Voltage or Constant-Current. The CV/CC signal is an open collector output with a 30V parallel zener, at J1-13 and referenced to the COM potential at J1-12 (connected internally to the negative local sense potential). When the power supply operates in Constant Voltage mode, the CV/CC output is open. When the Power Supply operates in Constant-Current mode, the CV/CC signal output is low (0-0.6V), with a maximum sink current of 10mA.

**CAUTION**

**DO NOT** connect the CV/CC signal to a voltage source higher than 30VDC. Always connect the CV/CC signal to a voltage source with a series resistor to limit the sink current to less than 10mA.

**5.10. PS\_OK Signal**

The PS\_OK signal indicates a fault condition in the Power Supply. PS\_OK is a TTL signal output at J1-16, referenced to IF\_COM at J1-2, 3 (Isolated Interface Common). When a fault condition occurs, the PS\_OK level is low with a maximum sink current of 1mA. When no fault condition occurs, the PS\_OK level is high with a maximum source current of 2mA. The following faults will set the PS\_OK to a fault state:

- \*OTP                      \*Enable/Disable open (power supply is disabled)
- \*OVP                     \*SO (Rear panel Shut-Off, power supply is shut off)
- \*Foldback               \*IEEE failure (With optional IEEE interface)
- \*AC Fail                 \*Output Off (by front panel or remote command)



## 5.11. Safe Start and Auto-Restart Modes

When turning on the Power Supply, it can start to its last setting of Output voltage and Output Current limit with the output enabled (Auto-Restart mode) or start with the output disabled (Safe-Start mode). Press and hold the OUT button to select between Safe-Start and Auto-Restart modes. The VOLTAGE display will continuously cycle between “SAF” and “AUT” every 3 seconds. Releasing the OUT pushbutton while one of the modes is displayed, selects that mode. The default setting at shipment is Safe-Start mode.

### 5.11.1. Automatic Restart Mode

In this mode, the Power Supply restores its last operation setting. Upon start-up, the output is enabled or disabled according to its last setting.

### 5.11.2. Safe Start Mode

In this mode, the Power Supply restores its last operation setting and sets the Output to the Off state. At start-up, the output is disabled and the Output voltage and Output current are zero. To enable the output and restore the last Output voltage and current limit values, momentarily press the OUT button.

## 5.12. Front Panel Locking

The front panel controls can be locked to protect against an operator accidentally changing the Power Supply settings.

### 5.12.1. Changing the Locking

Press and hold the front panel PREView button. The voltage display will toggle between locked front panel (“LFP”) and unlocked front panel (“UFP”). Select a mode by releasing the PREView button when the desired mode is displayed.

### 5.12.2. Unlocked Front Panel

This is the normal operating mode. The front panel controls are able to program and monitor the Power Supply parameters.

### 5.12.3. Locked Front Panel

When the front panel is locked, the following controls are *DISABLED*:

- VOLTAGE and CURRENT encoders.
- FOLD button.
- OUT button

The Power Supply will not respond to attempts to use these controls. The VOLT display will show “LFP” to indicate that the front panel is locked.

Other buttons, such as PREV and OVP/UVL may still be used to view the Power Supply settings.

### 5.13. Over Temperature Protection (OTP)

The OTP circuit shuts down the Power Supply before any internal components can exceed their safe internal operating temperature. When an OTP shutdown occurs, the display shows “OTP” and the ALARM LED blinks.

Resetting the OTP circuit can be automatic (non-latched) or manual (latched) depending on the Safe-Start or Auto-Restart mode.

- a) Safe-Start mode: In Safe-Start mode, the Power Supply stays Off after the Over-Temperature condition has been removed. The display continues to show “OTP” and the ALARM LED continues to blink. To reset the OTP circuit, press the OUT button (or send “OUT ON” command via the serial port).
- b) Auto-Restart mode: In Auto-Restart mode, the Power Supply recovers to its last setting automatically when the Over-Temperature condition is removed.

### 5.14. Last Setting Memory

The Power Supply is equipped with Last Setting Memory, which stores specific Power Supply parameters at each AC turn-off sequence.

#### Stored Parameters:

- OUT On or Off
- Output voltage setting (PV setting)
- Output current limit (PC setting)
- OVP level
- UVL level
- FOLD setting
- Start-up mode (Safe or Auto-Restart)
- Remote/Local (Local Lockout will return to Remote mode)
- Address setting
- Baud rate
- Locked/Unlocked Front Panel
- Parallel Master/Slave setting

Remote/Local, Address setting and Baud rate are related to Remote Digital Control and are explained in Chapter 8.

## 6. SERIES AND PARALLEL OPERATION

---

Users may connect the outputs of Genesys™ Power Supplies together to produce:

- Voltages greater than any one supply rating (series connection).
- Plus and minus polarity (series connection).
- More current than any one supply rating (parallel connection).

In addition to connecting the outputs together, Remote Analog control connections are used to ensure the supplies are properly sharing the total voltage or current. Remote Digital programming through the RS-232/RS-485, LAN, or IEMD is allowed for all power supplies.

### NOTE

*When a Power Supply is set to Remote Analog control then the corresponding voltage or current encoder (and their PREView settings) will not be effective.*

*Although the front panel seems like it can be used to adjust the Output settings, it is the Remote Analog control lines that actually set the programming limits.*

### 6.1. Series Operation

Power supplies of the **SAME MODEL** can be connected in series to obtain increased Output voltage. Split connection of the power supplies gives positive and negative Output voltage.

### CAUTION

Do not connect power supplies from different manufacturers in series or in parallel.

Use only the same models for series or parallel connection.

#### 6.1.1. Series Connection for Increased Output Voltage

In this mode, two units are connected so that their Output voltages are summed (Series Operation). Set the Output current limit of each Power Supply to the maximum that the load can handle without damage. It is recommended that diodes be connected in parallel with each unit Output to prevent reverse voltage during the startup sequence or in case one unit shuts down. Each diode should be rated for at least the Power Supply rated Output voltage and Output current. Refer to Fig.6-1 and 6-2 for Series Operation with Local and Remote sensing.

### WARNING



When power supplies are connected in series, and the load or one of the Output terminals is grounded to Chassis ground:

For models with  $V_{out} \leq 600VDC$  Rated Output, no point may be at a potential greater than  $\pm 600VDC$  from Chassis ground.

When using RS-232/RS-485, IEEE or LAN, refer to Section 3.9.8 (Grounding Outputs)

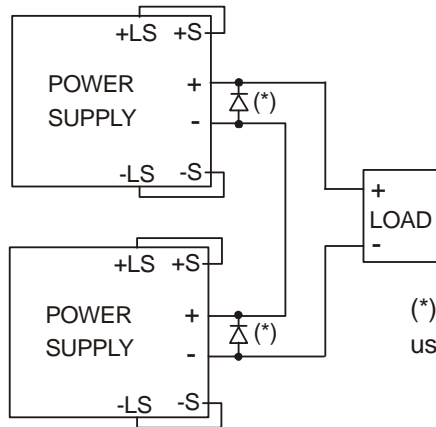

**Fig. 6-1: Series connection, local sensing**

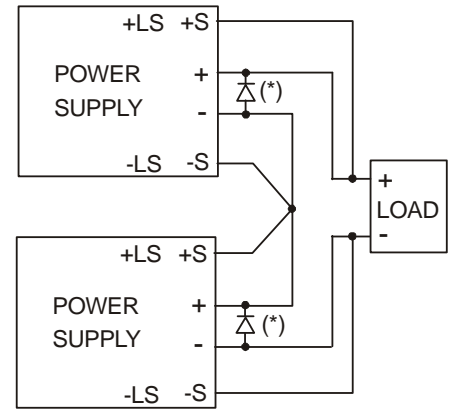

**Fig. 6-2: Series connection, remote sensing**

(\*) Diodes are user supplied.

### Remote programming in series operation for increased Output voltage:

1. Programming by external voltage: The Remote Analog programming circuits of this Power Supply are referenced to the negative local sense (-LS) potential. Therefore, the circuits used to control each series connected unit must be separated and floated from each other using the Isolated Analog interface option.
2. Using the SO function and PS\_OK signal: The Shut-Off and PS\_OK circuits are referenced to the isolated interface common, IF\_COM (J1-2,-3). The IF\_COM terminals of different units can be connected together to obtain a single control circuit for the power supplies connected in series. See Section 6.5.1 for details.
3. Programming by external resistor: Programming by external resistor is possible. Refer to Section 7.5 for details.
4. Programming via the Serial Communication port (RS-232/RS-485): The communication port is referenced to the isolated interface common, IF\_COM (J1-2, -3), which is isolated from the Power Supply output potential. Therefore, power supplies connected in series can be daisy-chained using the Remote-In and Remote-Out connectors. Refer to Chapter 8 for details.

### 6.1.2. Series Connection for Positive and Negative Output Voltage

In this mode, two units are configured as a positive and negative output. Set the Current limit of each power supply to the maximum that the load can handle without damage. It is recommended that diodes be connected in parallel with each unit output to prevent reverse voltage during start-up or in case one of the units shuts down. Each diode should be rated to at least the power supply rated Output voltage and Output current. Refer to Fig.6-3 for this operating mode.

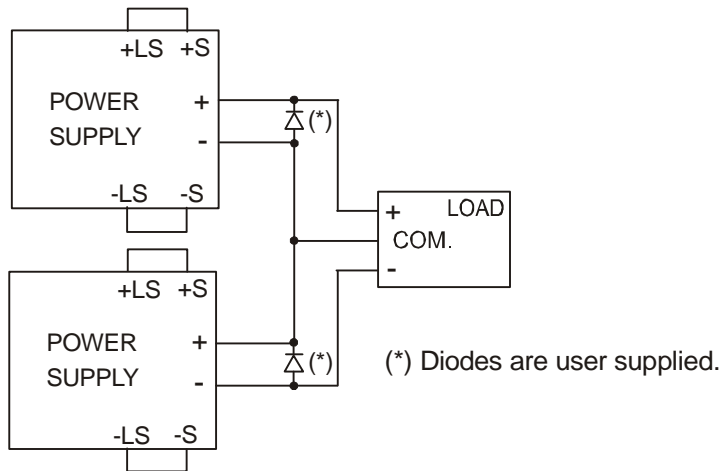

Fig 6-3: Series connection for positive/negative output voltages

#### Remote programming in series operation for positive and negative Output voltage

1. Programming by external voltage: The Analog programming circuits of this power supply are referenced to the negative local sense (-LS) potential. Therefore the circuits used to control series connected unit must be separated and floated from each other.
2. Using the SO function and PS\_OK: The Shut-Off and PS\_OK circuits are referenced to the isolated interface common, IF\_COM (J1-2,-3). The IF\_COM terminals of the units can be connected to obtain a single control circuit for the power supplies connected in series. See Section 6.2.1 for details.
3. Programming by external resistor: Programming by external resistor is possible. Refer to Section 7.5 for details.
4. Programming via the Serial Communication port (RS232/RS-485): The communication port is referenced to the isolated interface common, IF\_COM (J1-2,-3), which is isolated from the power supply output potential. Therefore, power supplies connected in series can be daisy-chained using the Remote-In and Remote-Out connectors. Refer to Chapter 8 for details.

## 6.2. Parallel Operation (Single-Wire/Two-Wire Method)

Up to four units of the SAME VOLTAGE and CURRENT RATING can be connected in parallel to provide up to four times the Output current capability of one power supply. One of the units operates as a Master and the remaining units are Slaves. The Slave units are Remote Analog programmed by the Master unit.

In Remote digital operation (RS-232/RS-485, IEMD or LAN), only the Master unit is programmed by the computer, although measurements and status can be read back from the Slave units.

In the simplest parallel setup (Basic), the Slave unit(s) Output current merely follows that of the Master unit. A shutoff daisy-chain may be added so when one power supply turns On or Off (or has a fault condition) in the parallel combination, they all will.

The Advanced Parallel option is a firmware setting which adds operator convenience by making the Master unit display the calculated sum of all unit Output currents while the Slave unit(s) Front Panel displays are disabled.

### NOTE

Use the “**Single-Wire**” method for 10kW Models where  $7.5V \leq V_{out} \leq 25V$ .  
Use the “**Two-Wire**” method for 10kW/15kW Models where  $25V < V_{out} \leq 600V$ .

### 6.2.1. Basic Parallel Operation

In this method, setting the units as Master and Slaves is made by the rear panel J1 Remote Analog connections and the setup switch SW1. Each unit displays its own Output current and Output voltage. To program the load current, the Master unit should be programmed to the total load current divided by the number of units in the system. Refer to the following procedure to configure multiple power supplies for Basic Parallel operation.

### CAUTION

Make sure that the connection between –V terminals is reliable to avoid disconnection during operation. Disconnection may cause damage to the power supply.

#### 1. Setting up the Master Unit

##### Two-Wire Method

Set the Master unit Output Voltage to the desired voltage. Program the Master unit Output Current to the desired load current divided by the number of parallel units. During operation, the Master unit operates in CV mode, regulating the load voltage at the programmed Output Voltage. Connect the sensing circuit to local or remote sensing as shown in **Fig. 6-7** or **Fig. 6-8**.

##### Single-Wire Method

Set the Master unit Output Voltage to the desired voltage. Program the Master unit Output Current to the desired load current divided by the number of parallel units. During operation, the Master unit operates in CV mode, regulated the load voltage at the programmed Output Voltage. Connect the sensing circuit to local or remote sensing as shown in **Fig. 6-9** or **Fig. 6-10**.

## 2. Setting up the Slave Units

### Two-Wire method

1. The Output Voltage of the Slave units should be programmed 2-5% higher than the Output Voltage of the Master unit to prevent interference with the Master unit's control. The Output Current setting of each Slave unit is programmed by the Master unit to the desired load current divided by the number of parallel units.
2. Set the rear panel setup switch SW1-2 to the UP position.
3. Set SW1-3 of the Slave unit(s) to the same setting as SW1-4 of the Master unit (both units should be either 5V or 10V Remote Analog programming).
4. Connect a wire jumper between J1-8 (LOC/REM) and J1-12 (COM) (refer to Table 4-4)
5. Connect J1-10 (IPGM) of the Slave unit to J1-25 (P) of the Master Unit.
6. Connect J1-23 (IPGM\_RTN) of the Slave unit to J1-12 (COM) of the Master unit.

### Single-Wire Method

1. The Output Voltage of the Slave units should be programmed 2-5% higher than the Output Voltage of the Master unit to prevent interference with the Master unit's control. The Output Current setting of each Slave unit is programmed by the Master unit to the desired load current divided by the number of parallel units.
2. Set the rear panel setup switch SW1-2 to the UP position.
3. Set SW1-3 of the Slave unit(s) to the same setting as SW1-4 of the Master unit (both units should be either 5V or 10V Remote Analog programming).
4. Connect a wire jumper between J1-8 (LOC/REM) and J1-12 (COM) (refer to Table 4-4).
5. Connect J1-10 (IPGM) of the Slave unit to J1-25 (P) of the Master unit.

During operation, the Slave units operate as a controlled current source, following the Master Output Current. It is recommended that the power system be designed so that each unit supplies up to 95% of its current rating because of the imbalance which may be caused by cabling and connection voltage drops.



#### **WARNING**

Failure to set the Slave unit voltage setting high enough will cause the Slave unit to go into Constant Voltage (CV) mode. When this happens, current will no longer be equally shared between the paralleled power supplies.

### 3. Daisy-Chain Connection for Shut-Off

This set up and connections are optional but are strongly recommended. It will shut down all power supplies when a fault condition occurs in any single power supply (see Figure 6-6).

- Switch SW1-5 should be in its DOWN position for all power supplies.
- Connect J1-16 (PS\_OK) of the Master Supply to J1-15 (SO) of the 'First' Slave Supply (if any).
- Connect J1-16 (PS\_OK) of the 'First' Slave Supply to J1-15 (SO) of the 'Second' Slave Supply (if any).
- Connect J1-16 (PS\_OK) of the 'Second' Slave Supply to J1-15 (SO) of the 'Third' Slave Supply (if any).
- Connect J1-16 (PS\_OK) of the 'Last' Slave Supply to J1-15 (SO) of the 'Third' Slave Supply (if any).
- Connect J1-2 or J1-3 (IF\_COM) of all power supplies together.

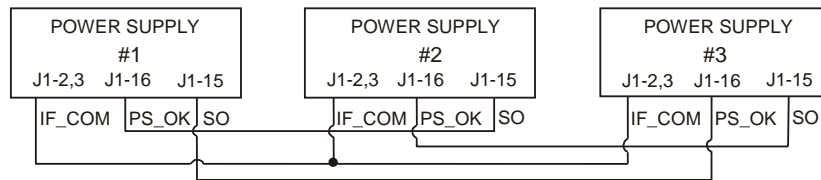

**Fig. 6-6: Daisy-chain connection**

### 4. Setting Over Voltage Protection (OVP)

The Master unit OVP setting should be programmed to the desired OVP level. The OVP setting of the Slave units should be programmed to a higher value than the Master OVP setting, which should prevent the Slave unit from shutting down before the Master unit does. Thus, when the Master unit shuts down due to an OVP condition, it programs the parallel system Output voltage to zero Output voltage.

If a Slave unit shuts down (when its OVP is set lower than the Master Output Voltage and, if all P/S are not daisy-chained), only that Slave unit would shut down, and the remaining Slave units would supply all the load current.

When there is a risk from Output over voltages, it is recommended to use the Shut-Off Daisy-Chain method (see "Daisy-Chain Connection for Shutoff" above) so all power supplies will turn off together.

### 5. Setting Foldback Protection (FB)

Foldback protection, as desired, may only be used with the Master unit. Thus, when the Master unit shuts down, it programs the parallel system Output voltage to zero Output voltage.



## 6. Connection to the Load

### Two-Wire Method

In parallel operation, power supplies can be connected for local or remote sensing. Refer to **Fig. 6-7 and 6-8** for typical connections of parallel power supplies. The figures show the connections for two (2) units, however the same connection method applies for up to four (4) units.

With local sensing, it is important to minimize the wire length and resistance. Also, the positive and negative wire resistance should be as close as possible to each other to achieve current balance between power supplies.

### Single-Wire Method

In Parallel operation, power supplies can be connected for local or remote sensing. Refer to **Fig. 6-9 and 6-10** for typical connections of parallel power supplies. The figures show the connections for two (2) units, however the same connection method applies for up to four (4) units.

With local sensing, it is important to minimize the wire length and resistance. Also, the positive and negative wire resistance should be as close as possible to each other to achieve current balance between power supplies.

### 6.2.2. Advanced Parallel Operation (Two-Wire/Single-Wire Method)

In this method, multiple supplies can be configured to parallel operation as a single power supply. The total load current and Output Voltage are displayed by the Master unit and can be read back from the Master unit. The Slave units display only their operating status (On, Off or Fault condition).

Refer to the following procedure to configure multiple supplies for Advanced Parallel operation.

#### NOTE

In an Advanced Parallel System, the output current measured by the Master supply is only the Master's current multiplied by two, three or four (depending on the number of Slave units).

The total parallel current may be different, subject to the combined output errors of the Slave units.

It is required to use the Shutoff Daisy-Chain with Advanced Parallel.

### 1. Advanced Parallel Configuration

#### Two-Wire Method

- Set SW1-2 to the DOWN position for the Master unit and UP for all Slave units.
- Connect a wire jumper between J1-8 (LOC/REM) and J1-12 (COM) for all Slave units.

- Connect J1-25 (IPGM) of the Master unit to J1-10 (P) of all Slave units.
- Connect J1-12 (COM) of the Master unit to J1-23 (IPGM\_RTN) of all Slave units.

#### **Single-Wire Method**

- Set SW1-2 to the DOWN position for the Master unit and UP for all Slave units.
- Connect a wire jumper between J1-8 (LOC/REM) and J1-12 (COM) for all Slave units.
- Connect J1-25 (IPGM) of the Master unit to J1-10 (P) of all Slave units.

The “Daisy-Chain Connection for Shutoff” is required for Advanced Parallel operation. These setup connections will shut down all the paralleled power supplies when a fault condition occurs in any single power supply (See Fig. 6-6).

In Advanced Parallel mode the fault reset function by ‘OUT’ button & by RS232 is not activated for Slave units.

## **2. Connection to the Load**

#### **Two-Wire Method**

In parallel operation, power supplies can be connected for local or remote sensing. Refer to **Fig. 6-7 and 6-8** for typical connections of parallel power supplies. The figures show the connections for two (2) units, however the same connection method applies for up to four (4) units.

With local sensing, it is important to minimize the wire length and resistance. Also, the positive and negative wire resistance should be as close as possible to each other to achieve current balance between power supplies.

#### **Single-Wire Method**

In parallel operation, power supplies can be connected for local or remote sensing. Refer to **Fig. 6-9 and 6-10** for typical connections of parallel power supplies. The figures show the connections for two (2) units, however the same connection method applies for up to four (4) units.

With local sensing, it is important to minimize the wire length and resistance. Also, the positive and negative wire resistance should be as close as possible to each other to achieve current balance between power supplies.

## **3. Setting the Units as Master or Slave**

- a) Depress and hold the **FINE** button for 3 seconds. The Master/Slave configuration will be displayed on the Current Display. Rotate the **CURRENT** encoder to obtain the desired mode. Refer to Table 6-1 for the CURRENT display and modes of operation.
- b) When the desired configuration is obtained, depress and release the **FINE** button or wait approximately 5 seconds.

CURRENT Display	Operating Mode
H1	Single supply (default)
H2	Master supply with 1 Slave supply
H3	Master supply with 2 Slave supplies
H4	Master supply with 3 Slave supplies
S	Slave supply

**Table 6-1: Setting Mode of Operation (Advanced Parallel Mode)**

#### 4. Master and Slave Units Default Operation

- a) When a unit is programmed to Slave mode, it enters the Remote mode with Local Lockout. In this mode, the Front Panel controls are disabled to prevent any accidental setting change (refer to Section 8.2.7 for details).
- b) The Slave unit's parameters will automatically set the following:
  - Output Voltage to approximately 102% of rated Output Voltage
  - Programmed Current to zero
  - UVL to zero volts
  - OVP to its maximum value
  - AST ON
  - OUT ON
  - Foldback Protection OFF
- c) The Master and Slave operating modes are stored in the power supply EEPROM memory when the AC Input power is turned Off. The system will return to the Master/Slave operating mode upon the re-application of AC Input power.

#### 5. Current Display Accuracy

In the Advanced Parallel mode, the Master unit calculates the total load current by multiplying the Master Output Current by the number of Slave units. In this method, the CURRENT display accuracy is 2% +/- 1 count. In cases where higher accuracy is required, it is recommended to use the Basic Parallel operation mode.

#### 6. To Release Units from Slave Mode

Slave units can be release from their operating mode by using the following procedure:

- a) Depress the **FINE** button for 3 seconds. The Master/Slave configuration will be displayed on the **CURRENT** display.
- b) Select **H1** mode using the **CURRENT** encoder.
- c) Depress the **FINE** button again or wait 5 seconds.
- d) Turn the AC input power Off to store the new setting(s).
- e) After exiting from Slave operation the unit's parameters will be set to:

- Programmed Voltage to zero.
- Programmed Current to zero.
- UVL to zero volts
- OVP to its maximum value
- AST OFF
- OUT OFF
- Foldback Protection OFF
- Locked Front Panel

**NOTE**

With local sensing it is important to minimize the wire length and resistance. Also, the positive and negative wire resistance should be as close as possible to each other to achieve current balance between the power supplies.

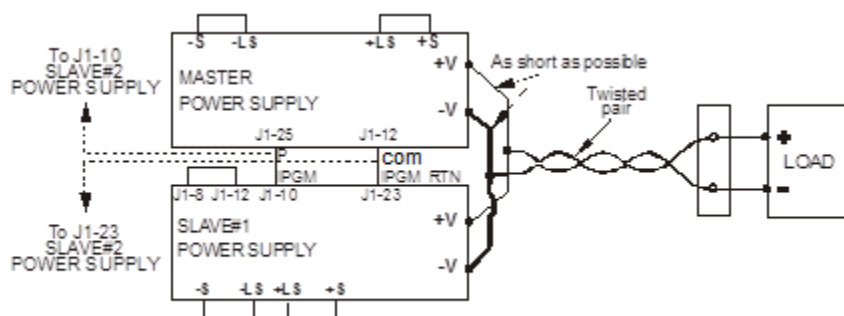

**Figure 6-7: Parallel Connection with Local Sensing (Two-Wire Method)**

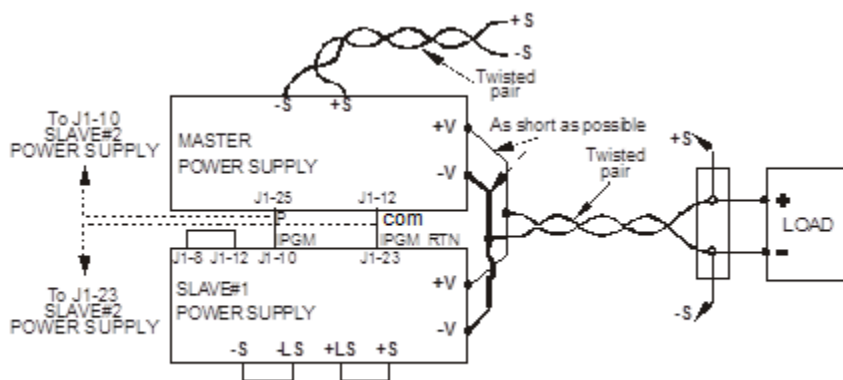

**Figure 6-8: Parallel Connection with Remote Sensing (Two-Wire Method)**

**CAUTION**

Make sure that the connection between  $-V$  terminals is reliable to avoid disconnection during operation. Disconnection may cause damage to the power supply.

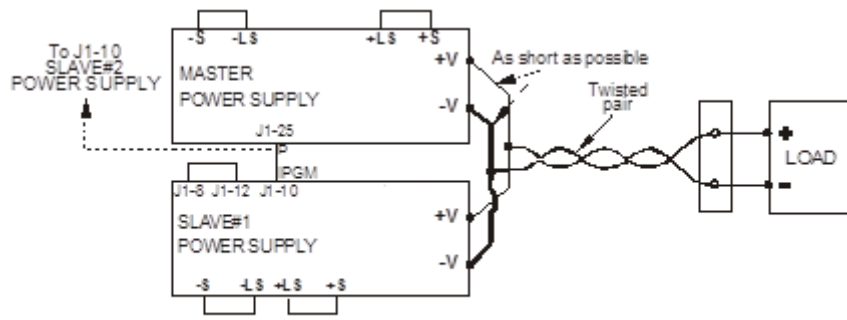

**Figure 6-9: Parallel Connection with Local Sensing (Single-Wire Method)**

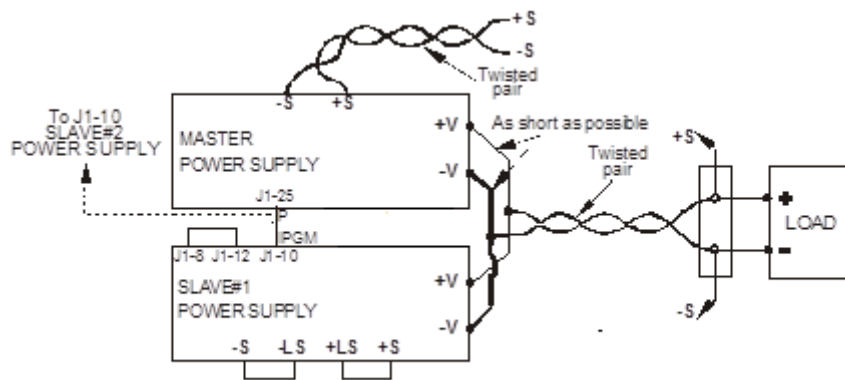

**Figure 6-10: Parallel Connection with Remote Sensing (Single-Wire Method)**

## 7. REMOTE AND ANALOG PROGRAMMING

---

### 7.1. Introduction

The rear panel connector J1 allows the user to program the power supply Output voltage and Output current limit with an analog device. J1 also provides monitoring signals for Output voltage and Output current. The programming range and monitoring signals range can be selected between 0-5V or 0-10V using the setup switch SW1. When the power supply is in Remote Analog programming, the serial communication port is active and can be used to read the power supply operating parameters.

#### CAUTION

COM (J1-12), VPGM\_RTN (J1-22) AND IPGM\_RTN (J1-23) terminals of J1 connect internally to the negative Local Sense potential (-LS). Do not connect these terminals to any potential other than negative Local Sense (-LS), as it may damage the power supply.

#### CAUTION

When the Isolated Analog Option is installed, do not apply any signals to the non-isolated VPGM and IPGM (J1-9 and J1-10) pins. All other J1 features may be used normally. Refer to Section 4.5 for a description of the J1 connector features.

### 7.2. Local/Remote Analog Selection

J1-8 (Fig.4-4) accepts a TTL signal or an Open-Short contact (referenced to J1-12) to select between Local or Remote Analog programming of the Output voltage and Output current limit.

In Local mode, the Output voltage and Output current limit can be programmed via the Front Panel VOLTAGE and CURRENT encoders or via the RS-232/RS-485 port. In Remote Analog mode, the Output voltage and Output current limit can be programmed by analog voltage or by programming resistors via J1-9 and -10 (Refer to Sections 7.4 and 7.5). Refer to Table 7-1 for the Local/Remote Analog control (J1-8) function and Setup switch SW1-1, -2 settings.

SW1-1, -2 setting	J1-8 function	Output voltage/ Current setting
Down (default)	No effect	Local
Up	"0" or Short	Remote
	"1" or Open	Local

**Table 7-1: Local/Remote Analog Control Function**

### 7.3. Local/Remote Analog Indication

J1-21 (Fig. 4-4) is an open collector output that indicates if the Power Supply is in Local mode or in Remote Analog mode. To use this output, connect a pull-up resistor to a voltage source of 30VDC maximum. Choose the pull-up resistor so that the sink current will be less than 5mA when the output is in the low state. Refer to Table 7-2 for the J1-21 function.

J1-8	SW1-1	SW1-2	J1-21 signal	Analog Mode
TTL "0" or short	Down	Down	Open	Local: Voltage/Current programming
	Down	Up	0-0.6V	Local: Voltage programming Remote: Current programming
	Up	Down	0-0.6V	Remote: Voltage programming Local: Current programming
	Up	Up	0-0.6V	Remote: Voltage/Current programming
TTL "1" or open	Down or Up	Down or Up	Open	Local: Voltage/Current programming

**Table 7-2: Local/Remote Analog indication**

### 7.4. Remote Voltage Programming of Output Voltage and Current Limit

**CAUTION**

To maintain the isolation of power supply and prevent ground loops, use an isolated programming source when operating the power supply via Remote Analog programming at the J1 connector.

Perform the following procedure to set the Power Supply to Remote Voltage programming:

- a) Turn the AC On/Off power switch to the OFF position.
- b) Set SW1-1 to the UP position for Output voltage external programming and SW1-2 to the UP position for Output current external programming.
- c) Set SW1-3 to select the programming Voltage Range according to Table 7-3.
- d) Ensure that SW1-7 and SW1-8 are in their DOWN (default) position.
- e) Connect a wire jumper between J1-8 and J1-12 (refer to Table 4-4).
- f) Connect the programming sources to the mating plug of J1 as shown in Fig.7-1. Observe the correct polarity for the voltage source.
- g) Set the programming sources to the desired levels and turn On the AC On/Off power switch. Then adjust the programming sources to change the power supply output level(s).

**NOTES:**

1. SW1-4, -5, -6 and -9 are not required for Remote Analog programming. Their settings can be determined according to the application.
2. The control circuits allow the user to set the Output voltage and Output current limit up to 5% over the model-rated maximum value. The Power Supply will operate within the extended range, however it is not recommended to operate the power supply outside of its Output voltage and Output current rating and performance is not guaranteed.

SW1-3 setting	Output Voltage programming VPGM (J1-9)	Current limit programming IPGM (J1-10)
UP	0-10V	0-10V
DOWN	0-5V	0-5V

**Table 7-3: SW1-3 Setting and Programming Range (Remote Voltage PGM)**

J1 connector, rear panel view

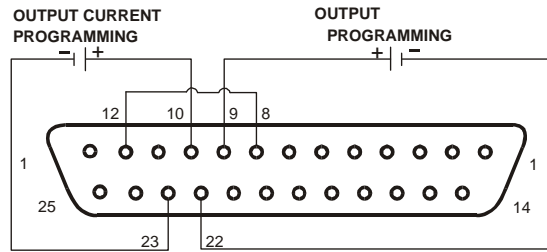

**Fig. 7-1: Remote voltage programming connection**

**NOTE**

Use a shielded cable (refer to Section 4.4)



## 7.5. Resistive Programming of Output Voltage and Current Limit

For Remote Resistive programming, internal current sources, for Output voltage and/or Output current control, supply 1mA of current through external programming resistors connected between J1-9, -22 and J1-10, -23. The voltage across the programming resistors is used as a programming voltage for the Power Supply. Resistance of 0 to 5kOhm or 0 to 10kOhm can be selected to program the Output voltage and Output current limit from zero to full-scale.

A variable resistor can control the Output over its entire range, or a combination of variable resistor and series/parallel resistors can control the Output over a restricted portion of its range.

Perform the following procedure to set the Power Supply to Remote Resistive programming:

- a) Turn the AC On/Off power switch to the OFF position.
- b) Set SW1-1 to the UP position for Output voltage external programming and SW1-2 to the UP position for Output current external programming.
- c) Set SW1-3 to select the programming resistor range according to Table 7-4.
- d) Set SW1-7 and SW1-8 to the UP position to enable the Resistive programming mode.
- e) Connect a wire jumper between J1-8 and J1-12 (refer to Table 4-4).
- f) Connect the programming resistors to the mating plug of J1 as shown in Fig.7-2.
- g) Set the programming resistors to the desired resistance and turn on the AC On/Off power switch. Then adjust the programming resistances to change the power supply output level(s).

### NOTES:

1. SW1-4, -5, -6 and -9 are not required for remote programming. Their settings can be determined according to the application requirements.
2. The control circuits allow the user to set the Output voltage and Output current limit up to 5% over the model-rated maximum value. The Power Supply will operate within the extended range, however it is not recommended to operate the Power Supply outside of its voltage and current rating and performance is not guaranteed.
3. To maintain the temperature stability specification of the Power Supply, the resistors used for programming should be stable and low noise resistors, with a temperature coefficient of less than 50ppm.
4. When Remote Resistive programming is used, front panel and computer control (via the serial communication port) of Output voltage and Output current are disabled.

SW1-3 setting	Output Voltage programming VPGM (J1-9)	Current limit programming IPGM (J1-10)
UP	0-10kOhms	0-10kOhms
DOWN	0-5kOhms	0-5kOhms

**Table 7-4: SW1-3 Setting and Programming Range (Remote Resistive PGM)**

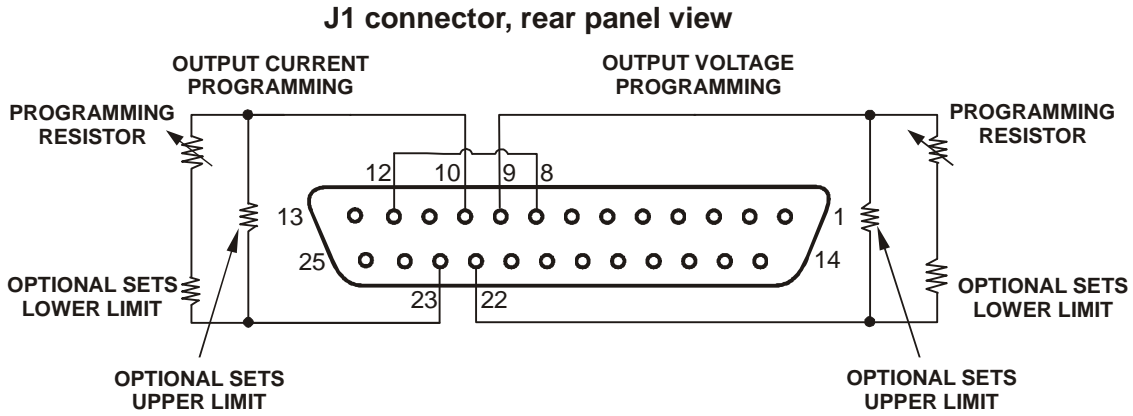

### 7.6. Remote Monitoring of Output Voltage and Current

The J1 connector, located on the Rear Panel provides Analog signals for monitoring the Output voltage and Output current. Selection of the voltage range between 0-5V or 0-10V is made by setup switch SW1-4. The monitoring signals represent 0 to 100% of the Power Supply Output voltage and Output current. The monitor outputs have 500 ohms of series output resistance. Ensure that the sensing circuit has an input resistance of greater than 500kOhms or Output voltage/Output current accuracy will be reduced.

Refer to Table 7-5 for required J1 connections, SW1-4 settings and monitoring voltage ranges.

Signal name	Signal function	J1 connection		Range	SW1-4
		Signal (+)	Return (-)		
V <sub>MON</sub>	V <sub>out</sub> monitor	J1-11	J1-12	0-5V	Down
I <sub>MON</sub>	I <sub>out</sub> monitor	J1-24			
V <sub>MON</sub>	V <sub>out</sub> monitor	J1-11	J1-12	0-10V	Up
I <sub>MON</sub>	I <sub>out</sub> monitor	J1-24			

**Table 7-5 Monitoring Signals Setting**

**Notes:**

- |  |  |
|--|--|
| 1. Radiated emissions, FCC requirements: | FCC requirements for radiated emissions use shielded cable for the analog control signals and connect the shield to chassis (A stud is provided near J1).            |
| 2. Front panel encoders operation:       | In Remote Analog mode the Output voltage and Output current can't be set by the VOLTAGE and CURRENT encoders.  |
| 3. Front panel PREView button:           | Use the PREView button to display the Output voltage and Output current setting defined by the encoders or Digital communication.                                    |
| 4. Communication:                        | Remote Analog mode - Power Supply parameters can be programmed and readback via the Digital communication port except the Output voltage and Output current setting. |

## 8. RS-232 & RS-485 REMOTE CONTROL

---

### 8.1. Introduction

This Chapter describes the operation of the Genesys™ 10kW and 15kW power supplies via the serial communication port. Details of the initial set-up, operation via RS-232 or RS-485, the command set and the communication protocol are described in this Chapter.

### 8.2. Configuration

#### 8.2.1. Default setting

The Power Supply is shipped with the following settings:

-Address	6	-Output	Off
-Baud-rate	9600	-Start up mode	Safe start
-RS-232/RS-485	RS-232	-OVP	Maximum
-V <sub>out</sub> setting	0	-UVL	0
-I <sub>out</sub> setting	Maximum	-Foldback	Off
		-Front panel	Unlocked (UFP)

#### 8.2.2. Address Setting

The Power Supply Address can be set to any address between 0 and 30. Follow the instructions described below to set the unit address.

- If the unit is in Remote mode (front panel REM/LOC LED illuminated), press the REM/LOC button to put the unit into Local mode.
- Press and hold the REM/LOC button for approximately 3 seconds. The VOLTAGE display will then indicate the communication port Address.
- Using the VOLTAGE adjust encoder, select the unit Address (0 to 30).
- After 3 seconds of idleness, the front panel display will revert and save the last Address setting.

To preview the unit Address setting at any time, press and hold the REM/LOC button for approximately 3 sec. The VOLTAGE display will indicate the Power Supply communication port Address.

#### 8.2.3. RS-232 or RS-485 Selection

To select between RS-232 or RS-485 set the rear panel setup switch SW1-6 position to:

- DOWN for RS-232
- UP for RS-485

#### 8.2.4. Baud rate Setting

Five optional Baud rates are possible: 1200, 2400, 4800, 9600 and 19200. To select the desired Baud rate, the following steps should be taken:

- If the unit is in Remote mode (front panel REM/LOC LED illuminated), press the REM/LOC button to put the unit into Local mode.
- Press and hold the REM/LOC button for approximately 3 seconds. The CURRENT display will show the communication port Baud rate.
- Using the CURRENT adjust encoder, select the desired Baud rate.
- After 3 seconds of idleness, the front panel display will revert and save the last Baud rate setting.

### 8.2.5. Setting the Unit into Remote or Local Mode

The unit will be put into Remote mode only via serial communication command.

Commands that will put the unit into Remote mode are:

RST            PV n            RMT n  
 OUT n        PC n  
 (for values of “n”, see Tables 7-4, 7-5 and 7-6)

There are two Remote modes:

- a) **Remote:** In this mode, return to Local can be made by the front panel REM/LOC button or via serial port command “RMT 0”. Set the unit into Remote mode via the serial port “RMT 1” command.
- b) **Local Lockout:** In this mode the unit can be returned to Remote mode via the serial port “RMT 1” command or by turning off the AC Input power (until the Front Panel display turns off) and then recycling AC Input power. In local Lockout mode, the front panel REM/LOC button is not active. Set the unit into Local Lockout mode via the serial port “RMT 2” command.

### 8.2.6. RS-232/RS-485 Port in Local Mode

When the Power Supply is in Local mode, it can receive queries or commands. If a query is received, the Power Supply will reply and remain in Local mode. If a command that affects the output is received, the Power Supply will perform the command and change to Remote mode.

### 8.2.7. Front Panel in Remote Mode

Front panel control in Remote mode is disabled except for:

1. PREV: use to preview the Output voltage and Output current limit setting.
2. OVP/UVL: use to preview the OVP/UVL settings.
3. LOC/REM: use to set the unit into Local mode.

In Local Lockout mode, only the PREV and OVP/UVL Front Panel functions are active.

### 8.3. Rear Panel RS-232/RS-485 Connector

The RS-232/RS-485 interface is accessible through the rear panel RS-232/RS-485 IN and RS-485 OUT connectors (8-contact RJ-45). The IN and OUT connectors are used to connect power supplies in a RS-232 or RS-485 daisy-chain to a controller. Refer to Fig. 8-1 for the IN/OUT connectors.

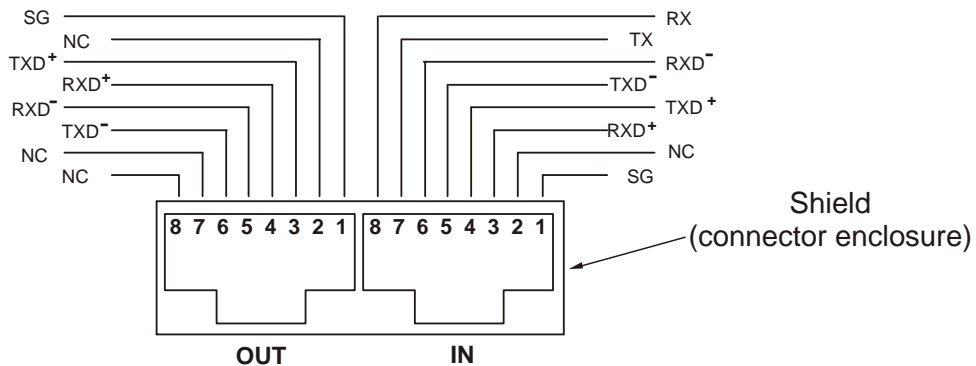

**Fig 8-1: Rear panel J3 IN/OUT connectors pinout**

Tx and Rx are used for RS-232 communication. Txd +/- and Rxd +/- are used for RS-485 communication. Refer to the RS-232 and RS-485 cable descriptions for connection details.

## 8.4. Connecting Power Supplies to the RS-232 or RS-485 Bus

### 8.4.1. Single Power Supply

- a) Select the desired interface, RS-232 or RS-485, using the rear panel setup switch SW1-6 (Section 4.3).
  - SW1-6 DOWN: RS-232
  - SW1-6 UP: RS-485
- b) Connect the rear panel J3-IN connector to the controller RS-232 or RS-485 Digital communication port using a suitable shielded cable.

Refer to Figures 8-2, 8-3 and 8-4 for available RS-232 and RS-485 cables.

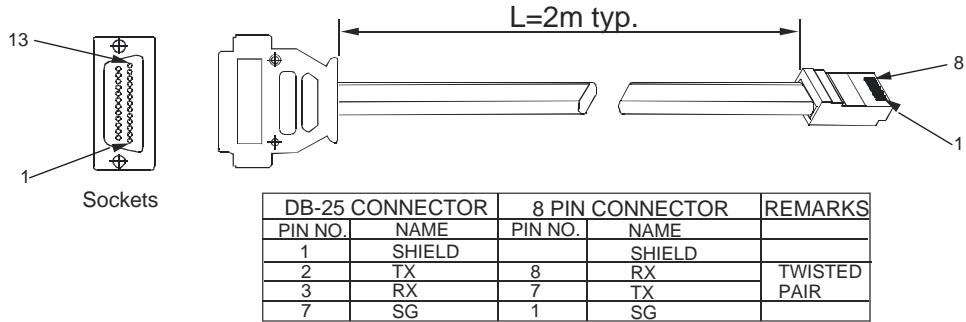

**Fig.8-2: RS-232 cable with DB25 connector (P/N: GEN/232-25)**

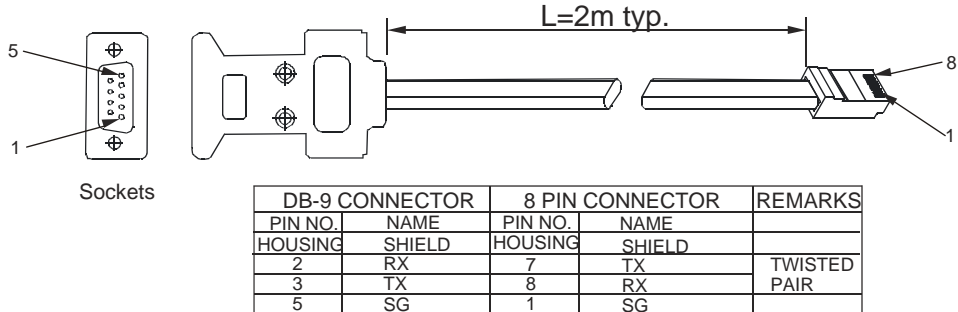

**Fig.8-3: RS-232 cable with DB9 connector (P/N: GEN/232-9)**

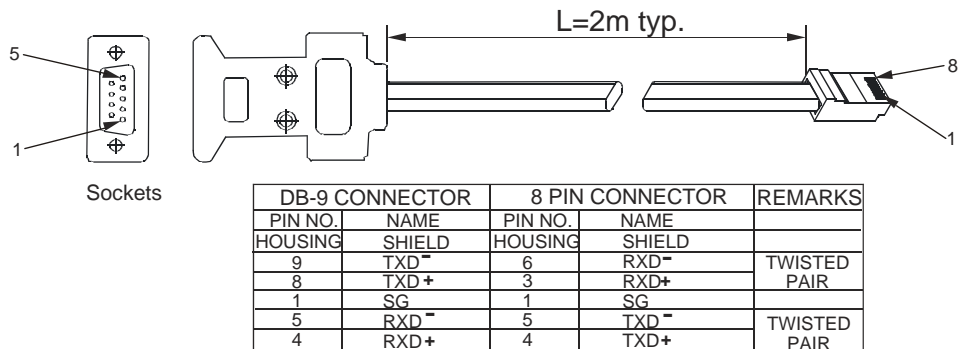

**Fig.8-4: RS-485 cable with DB9 connector (P/N: GEN/485-9)**

### 8.4.2. Multi Power Supply Connection to RS-232 or RS-485 Bus

Up to 31 units (0 - 30) can be connected to the the RS-232 or RS-485 Digital communication bus. The first unit connects to the controller via RS-232 or RS-485 (J3-IN) and the other units are connected with the RS-485 bus.

- a) First unit connection: Refer to Section 8.4.1 for connecting the first unit to the controller.
- b) Remaining units connection: The remaining units on the Digital communication bus are connected via their RS-485 interface.

Refer to Figure 8-5 for typical unit-to-unit connections.

- Set the rear panel setup switch SW1-6 to its UP position (RS-485).
- Using the “Linking” cable (Refer to Fig. 8-6), connect each unit J3-OUT connector to the next unit J3-IN connector.

### 8.5. Communication Interface Protocol

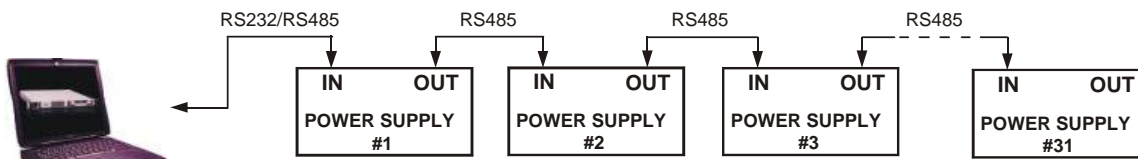

**Fig 8-5: Multiple power supply RS-232/RS-485 connection**

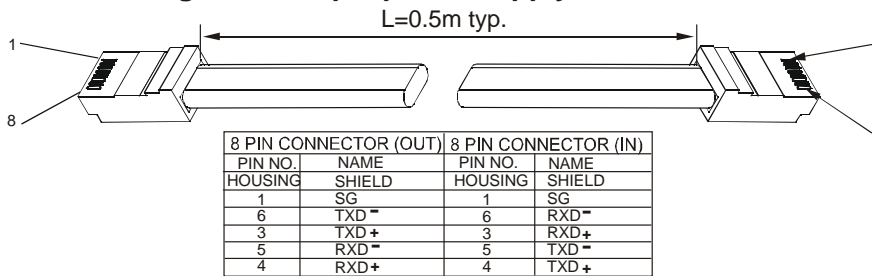

**Fig.8-6: Serial Link Cable with RJ-45 shielded connectors (P/N: GEN/RJ-45)**

#### 8.5.1. Data format

Serial data format is 8 bit, one start bit and one stop bit. No parity bit.

**NOTE**

*The address (“ADR n”) command must return an “OK” response before any other commands are accepted.*

#### 8.5.2. Addressing

The Address is sent separately from the command. It is recommended to add a 100msec delay between a queries or sent command to next unit addressing. Refer to Section 8.7.3 for details.

#### 8.5.3. End of Message

The end of message is the Carriage Return character (ASCII 13). The Power Supply ignores the Line Feed (ASCII 10) character.

#### 8.5.4. Command Repeat

The backslash character “\” will cause the last command to be repeated.

### 8.5.5. Checksum

The user may add a checksum (optional) to the end of the command. The checksum is “\$” followed by two hex characters. If a command or a query has a checksum, the response will also have a checksum. There is no CR between the command string and the “\$” sign.

Example: STT?3A

STAT?\$7B

### 8.5.6. Acknowledge

The Power Supply acknowledges received commands by returning an “OK” message. If an error is detected, the Power Supply will return an error message. The rules of checksum apply also to the Acknowledge.

### 8.5.7. Error Message

If an error is detected in a command or query, the Power Supply will respond with an error message. Refer to Section 8.6 for details.

### 8.5.8. Backspace

The backspace character (ASCII 8) clears the last character sent to the Power Supply.

## 8.6. Error Messages

The Power Supply will return error messages for illegal commands and illegal programming parameters. Refer to Table 8-1 for programming error messages and Table 8-2 for commands error messages.

**Table 8-1: Programming Error Messages**

Error Code	Description
E01	Returned when program voltage (PV) is programmed above acceptable range. Example: PV above ‘105% of supply rating’ or PV above “95% of OVP setting.”
E02	Returned when programming Output voltage below UVL setting.
E04	Returned when OVP is programmed below acceptable range. Example: OVP less than 5% of supply voltage rating’ plus ‘voltage setting’.
E06	Returned when UVL is programmed above the programmed Output voltage.
E07	Returned when programming the Output to ON during a fault shut down.

**Table 8-2: Commands Error Messages**

Error Code	Description
C01	Illegal command or query
C02	Missing parameter
C03	Illegal parameter
C04	Checksum error
C05	Setting out of range

## 8.7. Command Set Description

### 8.7.1. General Guide

1. Any command or argument may be in capital letters or small letters.
2. In commands with an argument, a space must be between the command and the argument.
3. For any command that sets a numeric value, the value may be up to 12 characters long.
4. Carriage Return: If the CR character (ASCII 13) is received by itself, the power supply will respond with "OK" and CR.

### 8.7.2. Command Set Categories

The command set is divided into four categories as follows:

1. Initialization control
2. ID control
3. Output control
4. Status control

### 8.7.3. Initialization Control Commands

#	Command	Description
1	ADR n	ADR is followed by address, which can be 0 to 30 and is used to access the power supply.
2	CLS	Clear status. Sets FEVE and SEVE registers to zero (refer to Section 8.11).
3	RST	Reset command. Brings the power supply to a safe and known state: Output voltage: zero, Remote: non-lockout remote, Output current: zero, Auto-start: Off, Output: Off, OVP: maximum, FOLD: Off, UVL: zero The conditional registers (FLT and STAT) are updated, the other registers are not changed.
4	RMT	Sets the power supply to local or remote mode: 1. RMT 0 or RMT LOC, sets the power supply into Local mode. 2. RMT 1 or RMT REM, sets the unit into remote mode. 3. RMT 2 or RMT LLO, sets the unit into Local Lockout mode (latched remote mode).
5	RMT?	Returns to the Remote mode setting: 1. "LOC" - The unit is in Local mode. 2. "REM" - The unit is in Remote mode. 3. "LLO" - The unit is in Local Lockout (latched remote) mode.
6	MDAV?	Returns if the MD Mode Option status option is installed. 1 indicates installed and 0 indicates not installed.
7	\	Repeat last command. If \<CR> is received, the power supply will repeat the last command.

### 8.7.4. ID Control Commands

#	Command	Description
1	IDN?	Returns the power supply model identification as an ASCII string: TDK-Lambda, GENX-Y
2	REV?	Returns the software version as an ASCII string.
3	SN?	Returns the unit serial number. Up to 12 characters.
4	DATE?	Returns date of last test. Date format: yyyy/mm/dd



### 8.7.5. Output Control Commands

#	Command	Description
1	PV n	Sets the Output voltage value in Volts. The range of voltage value is described in Table 8-6. The maximum number of characters is 12. See the following examples for PV n format: PV 12, PV 012, PV 12.0, PV 012.00, etc...
2	PV?	Reads the Output voltage setting. Returns the string "n" where "n" is the exact string sent in the PV n command. When in Local mode, returns the PREVIEW (front panel) settings in a 5 digit string.
3	MV?	Reads the actual Output voltage. Returns a 5 digit string. Example: 60V supply sends 01.150, 15.012, 50.000, etc...
4	PC n	Set the Output current value in Amperes. The range of current values is described in Tables 8-7 and 8-10. The maximum number of characters is 12. See the following examples for "PC n" format PC 10, PC 10.0, PC 010.00, etc... <b>See Note 1</b>
5	PC?	Reads the Output current setting. Returns the string "n" where "n" is the exact string sent in the "PC n" command. When in Local mode, returns the PREVIEW (front panel) settings in a 5 digit string.
6	MC?	Reads the actual Output current. Returns a 5 digit string. Example: 200A supply sends 000.50, 110.12, 200.00, etc... <b>See Note 2</b>
7	DVC?	Display Voltage and Current data. Data will be returned as a string of ASCII characters. A comma will separate the different fields. The fields, in order, are: Measured Voltage, Programmed Voltage, Measured Current, Programmed Current, Over Voltage Set Point and Under Voltage Set Point. Example: 5.9999,6.0000,010.02,010.00,7.500,0.000
8	STT?	Reads the complete power supply status. Returns ASCII characters representing the following data, separated by commas: <b>MV:</b> <actual (measured) voltage> <b>PC:</b> <programmed (set) current> <b>PV:</b> <programmed (set) voltage> <b>SR:</b> <status register, 2-digit hex> <b>MC:</b> <actual (measured) current> <b>FR:</b> <fault register, 2-digit hex> Example response: MV(45.201),PV(45), MC(4.3257), PC(10), SR(30), FR(00)
9	FILTER nn	Set the low pass filter frequency of the A to D Converter for Voltage and Current Measurement where nn = 18, 23 or 46Hz (default is 18Hz)
10	FILTER?	Returns the A to D Converter filter frequency: 18,23 or 46 Hz (default is 18Hz)
11	OUT n	Turns the Output to ON or OFF. Recover from Safe-Start, OVP or FLD fault. "OUT 1" (or "OUT ON"): Turn On. "OUT 0" (or "OUT OFF"): Turn Off
12	OUT?	Returns the Output On/Off status string. ON - Output On. OFF - Output Off.
13	FLD n	Sets the Foldback protection to ON or OFF. "FLD 1" (or "FOLD ON") - Arms the Foldback protection "FLD 0" (or "FOLD OFF") - Cancels the Foldback protection. When the Foldback protection has been activated, the "OUT 1" command will release the protection and re-arm it, while "FLD 0" will cancel the protection.
14	FLD?	Returns the Foldback protection status string: "ON": Foldback is armed. "OFF": Foldback is cancelled.
15	FBD nn	Add (nn x 0.1) seconds to the Fold Back Delay. This delay is in addition to the standard delay. The range of nn is 0 to 255. The value is stored in memory at AC power down and recovered at AC power up.
16	FBD ?	Supply returns the value of the added Fold Back Delay.
17	FBDRST	Reset the added Foldback Delay to zero.
18	OVP n	Sets the OVP level. The OVP setting range is given in Tables 8-8 and 8-11. The number of characters after OVP is up to 12. The minimum setting level is approximately 105% of the Output Voltage setting, or the values in Tables 8-8 and 8-11, whichever is higher. The maximum OVP setting level are shown in Tables 8-8 and 8-11. Attempting to program the OVP below this level will result in an execution error response ("E04") and the OVP setting stays unchanged.
19	OVP?	Returns the setting "n" where "n" is the exact string in the user's "OVP n". When in Local mode, returns the last setting from the front panel in a 4 digit string.
20	OVM	Sets the OVP level to the maximum level. Refer to Tables 8-8 and 8-11.
21	UVL n	Sets the Under Voltage Limit. Value of "n" may be equal to PV setting, but returns "E06" if higher. Refer to Tables 8-9 and 8-12 for the UVL programming range.

#	Command	Description
22	UVL?	Returns the setting "n" where "n" is the exact string in the user's "UVL n". When in Local mode, returns the last setting from the front panel in a 4 digit string.
23	AST n	Sets the Auto-restart mode to ON or OFF. AST 1 (or AST ON): Auto-Restart On. AST 0 (or AST OFF): Auto-Restart Off.
24	AST?	Returns the string Auto-Restart mode status.
25	SAV	Saves present settings. The settings are the same as power-down last setting. These settings are erased when the supply power is switched Off and the new "last settings" are saved.
26	RCL	Recalls last settings. Settings are from the last power-down or from the last "SAV" command.
27	MODE?	Returns the Power Supply operating mode. When the Power Supply is On (OUT 1) it will return "CV" or "CC". When the power supply is Off (OUT 0 or fault shutdown) it will return "OFF".
28	MS?	Returns the Master/Slave setting. Master: n = 1, 2, 3, or 4; Slave: n=0

**NOTES:**

1. *In Advanced Parallel mode (refer to Sec. 6.2.1), "n" is the total system current.*
2. *In Advanced Parallel mode, "MC?" returns the Master unit current multiplied by the number of Slave units +1.*

## 8.8. Global Output Commands

### 8.8.1. Description

Global commands are a way to quickly set all power supplies on the RS-232/RS-485 Digital communication bus to the same setting. For example, sending “GOUT OFF” is one way to turn a whole group of supplies OFF at nearly the same time.

#### CAUTION



After sending a global command, it is important that the controller wait 200 mSec before sending any more RS-232/RS-485 messages.

If the command contains an error, such as incorrect syntax or range values, *NO* error response will be returned by any power supply.

**Table 8.5: Global Output Commands**

1	GRST	Reset. Brings the Power Supply to a safe and known state: Output voltage: 0V, Output current: 0A, OUT: Off, Remote: RMT 1, AST: Off OVP: Max, UVL: 0. The conditional register (FLT and STAT) are updated. Other registers are <i>not</i> changed. Non-Latching faults (FB, OVP, SO) are cleared, OUT fault stays
2	GPV n	Sets the Output voltage value in volts. The range of Output voltage values is shown in Table 8-6. 'n' may be up to 12 characters plus decimal point.
3	GPC n	Program the Output current value in amperes. The range of Output current values is shown in Table 8-7 and 8-10. 'n' may be up to 12 characters plus decimal point.
4	GOUT	Turns the Output to ON or OFF: “OUT 1/ON” = turn On “OUT 0/OFF” = turn Off, clears CV and CC bits in the Status Condition (STAT). “OUT ON” will respond with “E07” if the Output cannot be turned on because of a latching fault (OTP, AC, ENA, SO) shutdown.
5	GSAV	Save present settings (to RAM memory) per Section 5.14. Same settings as power-down last settings listed in Section 5.14 except the unit Address and Baud rate are not saved These settings are erased when the Power Supply is switched Off and the new “Last Settings” are saved.
6	GRCL	Recall last settings. Settings are from last power-down or from last ‘SAV’ or ‘GSAV’ command. Unit Address and Baud rate are not recalled so communication is not interrupted.

#### NOTE

*The Power Supply can accept values greater than 5% of the maximum value called out in Table 8-6, however it is not recommended to program the Power Supply beyond the rated Output Voltage/Current values and performance is not guaranteed.*

**Table 8-6: Voltage Programming Range (10kW/15kW)**

Model Rated Output Voltage (VDC)	Minimum (VDC)	Maximum (VDC)
7.5	0.0	7.5
10	0.0	10.0
12.5	0.0	12.5
20	0.0	20.0
25	0.0	25.0
30	0.0	30.0
40	0.0	40.0
50	0.0	50.0
60	0.0	60.0
80	0.0	80.0
100	0.0	100.0
125	0.0	125.0
150	0.0	150.0
200	0.0	200.0
250	0.0	250.0
300	0.0	300.0
400	0.0	400.0
500	0.0	500.0
600	0.0	600.0

**Table 8-7: Current programming range (10kW)**

Model	Minimum (A)	Maximum (A)
7.5-1000	0.0	100.0
10-1000	0.0	100.0
12.5-800	0.0	800.0
20-500	0.0	500.0
25-400	0.0	400.0
30-333	0.0	333.0
40-250	0.0	250.0
50-200	0.0	200.0
60-167	0.0	167.0
80-125	0.0	125.0
100-100	0.0	100.0
125-80	0.0	80.0
150-66	0.0	66.0
200-50	0.0	50.0
250-40	0.0	40.0
300-33	0.0	33.0
400-25	0.0	25.0
500-20	0.0	20.0
600-17	0.0	17.0

**Table 8-8: OVP Programming Range (10kW)**

Model Rated Output Voltage (V)	Minimum (V)	Maximum (V)
7.5-1000	0.75	7.88
10-1000	1.0	10.5
12.5-800	1.25	13.13
20-500	2.0	21.0
25-400	2.5	26.25
30-333	3.0	31.5
40-250	4.0	42.0
50-200	5.0	52.5
60-167	6.0	63.0
80-125	8.0	84.0
100-100	10.0	105.0
125-80	12.5	131.25
150-66	15.0	157.5
200-50	20.0	210.0
250-40	25.0	262.5
300-33	30.0	315.0
400-25	40.0	420.0
500-20	50.0	525.0
600-17	60.0	630.0

**Table 8-9: UVL Programming Range (10kW)**

Model Rated Output Voltage (V)	Minimum (V)	Maximum (V)
7.5-1000	0.0	7.125
10-1000	0.0	9.5
12.5-800	0.0	11.875
20-500	0.0	19.0
25-400	0.0	23.75
30-333	0.0	28.5
40-250	0.0	38.0
50-200	0.0	47.5
60-167	0.0	57.0
80-125	0.0	76.0
100-100	0.0	95.0
125-80	0.0	118.75
150-66	0.0	142.5
200-50	0.0	190.0
250-40	0.0	237.5
300-33	0.0	285.0
400-25	0.0	380.0
500-20	0.0	475.0
600-17	0.0	570.0

**Table 8-10: Current programming range (15kW)**

Model	Minimum (A)	Maximum (A)
30-500	0.0	500.0
40-375	0.0	375.0
50-300	0.0	300.0
60-250	0.0	250.0
80-187.5	0.0	187.5
100-150	0.0	150.0
125-120	0.0	120.0
150-100	0.0	100.0
200-75	0.0	75.0
250-60	0.0	60.0
300-50	0.0	50.0
400-37.5	0.0	37.5
500-30	0.0	30.0
600-25	0.0	25.0

**Table 8-11: OVP Programming Range (15kW)**

Model Rated Output Voltage (V)	Minimum (V)	Maximum (V)
30-500	3.0	31.5
40-375	4.0	42.0
50-300	5.0	52.5
60-250	6.0	63.0
80-187.5	8.0	84.0
100-150	10.0	105.0
125-120	12.5	131.25
150-100	15.0	157.5
200-75	20.0	210.0
250-60	25.0	262.5
300-50	30.0	315.0
400-37.5	40.0	420.0
500-30	50.0	525.0
600-25	60.0	630.0

**Table 8-12: UVL Programming Range (15kW)**

Model Rated Output Voltage (V)	Minimum (V)	Maximum (V)
30-500	0.0	28.5
40-375	0.0	38.0
50-300	0.0	47.5
60-250	0.0	57.0
80-187.5	0.0	76.0
100-150	0.0	95.0
125-120	0.0	118.75
150-100	0.0	142.5
200-75	0.0	190.0
250-60	0.0	237.5
300-50	0.0	285.0
400-37.5	0.0	380.0
500-30	0.0	475.0
600-25	0.0	570.0

## 8.9. Fast Queries

These are commands that read a response very quickly from the Power Supply. They use unprintable character codes. They allow the Power Supply to avoid the normal command processing delays.

The processing time for these queries is typically 2ms, so total query speed is 2ms plus the RS-232/RS-485 transmission time.

Since these queries embed the power supply address (0 to 30), there is no need to first send the "ADR n" addressing command.

### 8.9.1. Fast Test for Connection

This is an addressed query that is good for scanning to see what power supplies are "on line". If no response is returned within 10ms, the control program has determined that no Power Supply is connected at that address.

#### **Query Format:**

Send two bytes of unreadable characters. First:

Byte 1 = 1010 1010 = AA hex

Byte 2 = 000x xxxx (where xxxxx is the address of the supply in binary)

#### **Query Response:**

The power supply returns 5 characters:

First a "1" = 31 hex if Multi-drop is enabled

or a "0" = 30 hex if Multi-drop is not enabled

Then four printable characters:

Dollar sign "\$"

Checksum (two ASCII hex characters) = "30" or "31"

Carriage-return terminator

### 8.9.2. Fast Read Registers

This query allows fast polling of the status and error registers for many power supplies on a RS-232/RS-485 link. It is useful for checking many supplies to verify they are all operating as expected.

#### **Query Format:**

Send two bytes of unreadable characters. First:

100x xxxx (where xxxxx is the address of the supply in binary)

And send it a second time:

100x xxxx send 2 characters sequentially

#### **Query Response:**

The power supply returns 16 characters including the contents of the status and fault registers (see Section 8.11 and Figure 8-7).

First twelve bytes contain binary data from six registers:

STAT? SENA? SEVE? FLT? FENA? FEVE?

Then four printable characters:

Dollar sign "\$"

Checksum (two ASCII hex characters)

Carriage-return terminator

### 8.9.3. Read Power-On Time

This query allows you to read how many minutes the Power Supply has been running since it was built. The accuracy, in minutes, is not guaranteed for time critical applications.

#### **Query Format:**

Send two bytes of unreadable characters. First:

Byte 1 = 1010 0110 = A6 hex

Byte 2 = 000x xxxx (where xxxxx is the address of the supply in binary)

#### **Query Response:**

The Power Supply returns 12 characters:

First is the minutes as a 32 Bit integer as 8 ASCII Hex bytes

Then four printable characters:

Dollar sign "\$"

Checksum (two ASCII hex characters) = "30" or "31"

Carriage-return terminator

### 8.9.4. Service Request Messages

A Genesys™ power supply can automatically send messages over the RS-232/RS-485 lines when there is a change in operating mode or if a fault occurs. These messages are called Service Requests or SRQs. They are setup with the RS-232/RS-485 status registers (see Section 8.11 and 8.12).

Since the SRQ messages may be sent from any supply at any time, there is a chance they can collide with other messages from other supplies. The controller software has to be developed enough to read messages that may come at any time, and to recover if messages are corrupted by collisions.

If Service Request messaging is needed, please contact TDK-Lambda for assistance. Several special communication commands and settings can be provided to help with this issue.

### 8.10. Status and Error Commands

The following commands operate on the Power Supply status and error registers. They are used to read operating conditions and fault conditions, they can be set to latch changes in these conditions, and masks can be set up to send service requests messages if the conditions change.

Refer to Section 8.11 and Figure 8-7 for more instructions on using these register commands.

**Table 8-9 Status and Error Register Commands**

#	Command	Description
1	FLT?	Reads Fault Conditional Register. Returns 2-digit hex.
2	FENA	Set Fault Enable Register using 2-digit hex.
3	FENA?	Reads Fault Enable Register. Returns 2-digit hex.
4	FEVE?	Reads Fault Event Register. Returns 2-digit hex. Clears bits of Fault Event
5	STAT?	Reads Status Conditional Register. Returns 2-digit hex.
6	SENA	Sets Status Enable Register using 2-digit hex.
7	SENA?	Reads Status Enable Register. Returns 2-digit hex.
8	SEVE?	Reads Status Event register. Returns 2-digit hex. Clears bits of Status Event

## 8.11. Status, Error, and SRQ Registers

### 8.11.1. General Description

This Section describes the structure and operation of the six status, error, and SRQ registers. The registers can be set or read via the RS-232/RS-485 commands.

Refer to Fig. 8-7 for the Status and Error Registers Diagram.

NOTE: these registers operate in a way that is similar to the IEEE-488 and SCPI registers (as used by the Genesys™ with the “-IEMD” option), but the structure and command set is different.

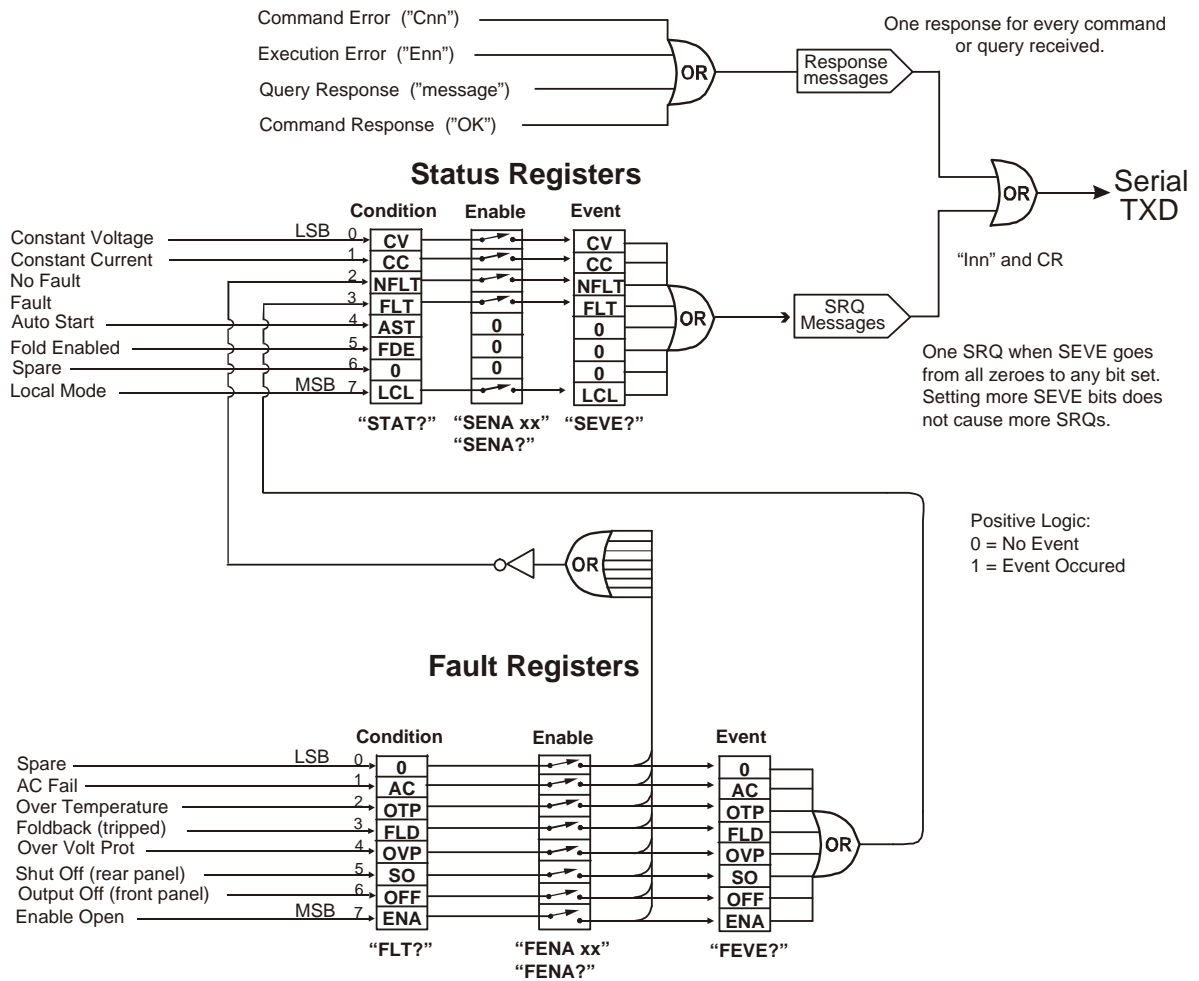

Fig.8-7: Status and Error Registers Diagram



## Conditional Registers

The fault Condition Register and the Status Condition Register are read only registers that the user may read to see the condition of the Power Supply. Refer to Table 8-8 for description of the Fault Condition Register bits and Table 8-9 for the Status Condition register bits.

**Table 8-10: Fault Condition Register (FLT?)**

BIT	Fault name	Fault symbol	Bit Set condition	Bit Reset condition
0 (LSB)	Spare bit	SPARE	Fixed to zero	Fixed to zero
1	AC Fail	AC	AC fail has occurred.	The AC input returns to normal.
2	Over temperature	OTP	OTP shutdown has occurred.	The power supply cools down.
3	Foldback	FOLD	Foldback shutdown has occurred	The supply Output is turned On by front panel button or OUT 1 command.
4	Over voltage	OVP	OVP shutdown has occurred.	The supply Output is turned ON by front panel button or OUT 1 command.
5	Shut Off	SO	Rear panel J1 "Shut Off" condition has occurred.	Rear panel J1 "Shut Off" condition removed.
6	Output Off	OFF	Front panel OUT button pressed to Off.	The supply Output is turned On by front panel button or OUT 1 command.
7(MSB)	Enable	ENA	Rear panel J1 Enable terminal (J1-1 & J1-14) opened.	Rear panel J1 Enable terminals closed.

**Table 8-11: Status Condition Register (STAT?)**

BIT	Fault name	Fault symbol	Bit Set condition	Bit Reset condition
0 (LSB)	Constant Voltage	CV	Output is On and the supply in CV.	Output is ON and the supply is not in CV.
1	Constant Current	CC	Output is ON and the supply in CC.	Output is ON and the supply is not in CC.
2	No Fault	NFLT	The power supply is operating normally or fault reporting is not enabled. See "OUT n" command in Section 8.7.5.	One or more faults are active and fault reporting is enabled (using "FENAx").
3	Fault active	FLT	One or more faults are enabled and occur.	Fault Event Register cleared (FEVE?).
4	Auto-Restart Enabled	AST	Supply is in Auto-Restart mode (from Front Panel or serial command).	Supply is in Safe-Start mode (from Front Panel or serial command).
5	Fold Enabled	FDE	Fold protection enabled (from Front Panel or serial command).	Fold protection disabled (from Front Panel or serial command).
6	Spare bit	SPARE	Fixed to zero.	Fixed to zero.
7(MSB)	Local Mode	LCL	Supply in Local mode.	Supply in Remote mode or Local-Lockout mode.

### 8.11.2. Service Request: Enable and Event Registers

The conditional Registers are continuously monitored. When a change is detected in a register bit, which is enabled, the power supply will generate an SRQ message.

The SRQ message is: "Inn" terminated by CR, where the nn is the power supply Address. The SRQ will be generated either in Local or Remote mode.

Refer to Tables 8-10 through 8-13 for details of the Enable and Event registers.

### A. Fault Enable Register (FENA nn, FENA?)

The Fault Enable Register is set to the enable faults SRQs.

**Table 8-12: Fault Enable Register**

BIT	Enable bit name	Fault symbol	Bit Set condition	Bit reset condition
0 (LSB)	Spare bit	SPARE	User command: "FENA nn" where nn is hexadecimal	User command: "FENA nn" where nn is hexadecimal (if nn="00", no fault SRQs will be generated).
1	AC Fail	AC		
2	Over Temperature	OTP		
3	Foldback	FOLD		
4	Over Voltage	OVP		
5	Shut Off	SO		
6	Output Off	OFF		
7(MSB)	Enable	ENA		

### B. Fault Event Register (FEVE?)

The Fault Event will set a bit if a condition occurs and it is enabled. The register is cleared when FEVE?, CLS or RST commands are received.

**Table 8-13: Fault Event Register**

BIT	Enable bit name	Fault symbol	Bit Set condition	Bit reset condition
0 (LSB)	Spare bit	SPARE	Fault condition occurs and it is enabled. The fault can set a bit, but when the fault clears, the bit remains set.	Entire Event Register is cleared when user sends "FEVE?" command to read the register. "CLS" and power-up also clear the Fault Event Register (the Fault Event Register is not cleared by RST).
1	AC Fail	AC		
2	Over Temperature	OTP		
3	Foldback	FOLD		
4	Over Voltage	OVP		
5	Shut Off	SO		
6	Output Off	OFF		
7(MSB)	Enable	ENA		

### C. Status Enable Register (SENA nn, SENA?)

The Status Enable Register is set by the user to enable SRQs from changes in Power Supply status.

**Table 8-14: Status Enable Register**

BIT	Status name	Status symbol	Bit Set condition	Bit reset condition
0 (LSB)	Constant Voltage	CV	User command: "SENA nn" is received, where nn is hexadecimal bits.	User command: "SENA nn" is received, where nn is hexadecimal bits. If "nn"=00, no SRQ is sent when there is a change in Status Condition Register.
1	Constant Current	CC		
2	No Fault	NFLT		
3	Fault active	FLT		
4	Auto-Restart enabled	AST	Always zero	Always zero
5	Fold enabled	FDE	Always zero	Always zero
6	Spare	Spare	Always zero	Always zero
7 (MSB)	Local Mode	LCL	"SENA nn" command	"SENA nn" command

#### D. Status Event Register (SEVE?)

The Status Event Register will set a bit if a change in the Power Supply status occurs and it is enabled. The register is cleared when the “SEVE?” or “CLS” commands are received. A change in this register will generate SRQ.

**Table 8-15: Status Event Register (SEVE?)**

BIT	Status name	Status symbol	Bit Set condition	Bit reset condition
0 (LSB)	Constant Voltage	CV	Changes in status occurs and it is enabled. The change can set a bit, but when the change clears the bit remains set.	Entire Event Register is cleared when user sends “SEVE?” command to read the register. “CLS” and power-up also clear the Status Event Register.
1	Constant Current	CC		
2	No Fault	NFLT		
3	Fault active	FLT		
4	Auto-Restart enabled	0	Always zero	
5	Fold enabled	0	Always zero	
6	Spare	0	Always zero	
7 (MSB)	Local Mode	LCL	Unit is set to Local by pressing front panel REM/LOC button	

#### 8.12. Serial Communication Test Set-Up

Use the following instructions as basic set-up to test the serial communication operation.

**8.12.1. Equipment:** PC with Windows Hyper Terminal, software installed, Genesys™ Power supply, RS-232 cable.

**8.12.2. PC set-up:**

- 2.1 Open Hyper Terminal.....New Connection
- 2.2 Enter a name
- 2.3 Connect to..... Direct to Com 1 or Com 2
- 2.4 Configure port properties:
  - Bits per second.....9600
  - Data bits.....8
  - Parity.....None
  - Stop bits.....1
  - Flow control.....None
  - File.....Properties
- 2.5 Open Properties in the program
- 2.6 Setting: ASCII Set Up

Select Echo characters locally, select send line ends with line feed. On some PC systems, pressing the number keypad “Enter” will distort displayed messages. Use the alphabetic “Enter” instead.

#### 8.12.3. Power Supply Set-Up:

Connect the power supply to the PC using the RS-232 cable.

Set via the front panel: Baud rate: 9600, Address: 06 (default).

Set via the rear panel: RS-232/RS-485 to RS-232 (refer to Section 8.2.3).

#### 8.12.4. Communication Test:

Select a power supply at address 6:  
PC write: ADR 06  
Power supply response: "OK"

Command test:  
PC write: OUT 1  
Power supply response: "OK"  
PC write: PV 5.0  
Power supply response: "OK"  
PC write: PC 10.0  
Power supply response: "OK"

Read back the Output voltage test:  
PC write: MV?  
Power supply response "05.00" (or voltage as seen on the front panel display)

The power supply should turn on and the display will indicate the actual Output voltage and the actual Output current.

## 9. ISOLATED ANALOG PROGRAMMING OPTION

### 9.1. Introduction

Isolated Analog Programming is an internal option card for Remote Analog programming of the Genesys™ power supply series. The option is factory installed and cannot be obtained with IEMD or LAN Interfaces. Output Voltage and Current Limit can be programmed and read back through optically isolated signals which are isolated from all other ground references in the power supply.

There are two types of Isolated Analog programming cards:

- a) 0-5V/0-10V option (P/N: IS510): Using 0-5V or 0-10V signals for programming and readback.
- b) 4-20mA option (P/N: IS420): Using current signals for programming and readback.

### 9.2. Specifications

#### 9.2.1. 0-5V/0-10V Option (PN: IS510)

Programming Inputs	Output voltage programming accuracy	%	+/-1
	Output current programming accuracy	%	+/-1
	Output voltage programming temperature coefficient	ppm/°C	+/-100
	Output current programming temperature coefficient	ppm/°C	+/-100
	Input impedance	Ohm	1M
	Absolute maximum voltage	VDC	0-15
	Max. voltage between program inputs and supply outputs	VDC	600
Monitoring Outputs	Output voltage monitoring accuracy	%	+/-1.5
	Output current monitoring accuracy	%	+/-1.5
	Output Impedance (see Note)	Ohm	100
	Max. voltage between monitoring outputs and supply outputs	VDC	600

#### NOTE:

Use 100kohms minimum input impedance for the monitoring circuits to minimize the readback error.

#### 9.2.2. 4-20mA Option (PN: IS420)

Programming Inputs	Output voltage programming accuracy	%	+/-1
	Output current programming accuracy	%	+/-1
	Output voltage programming temperature coefficient	ppm/°C	+/-100
	Output current programming temperature coefficient	ppm/°C	+/-100
	Input impedance	Ohm	1M
	Absolute maximum input current	VDC	0-15
	Max. voltage between program inputs and supply outputs	VDC	600
Monitoring Outputs	Output voltage monitoring accuracy	%	+/-1.5
	Output current monitoring accuracy	%	+/-1.5
	Maximum load impedance	Ohm	100
	Max. voltage between monitoring outputs and supply outputs	VDC	600

### 9.3. Isolated Programming & Monitoring Connector

Refer to Table 9-1 for a detailed description of the rear panel Isolated Programming & Monitoring connector. To provide the lowest noise performance, it is recommended to use shielded-twisted pair wiring.

Refer to Fig.9-1 for description of the connector.

Isolated programming plug P/N: MC1.5/8-ST-3.81, Phoenix.

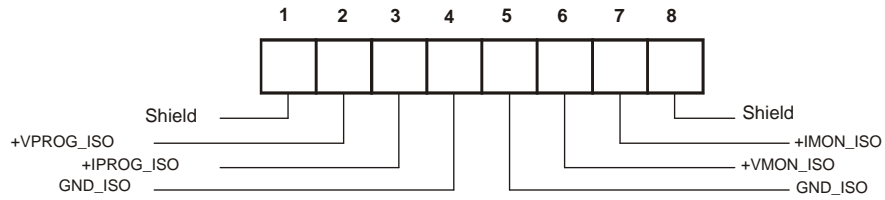

**Fig. 9-1: Isolated Programming & Monitoring connector**

**Table 9-1: Detailed Description of Isolated Programming & Monitoring Connector**

Terminal	Signal name	Function	Range 0-5V/0-10V IS510 option	Range 4-20mA IS420 option
1	SHLD	Shield, connected internally to chassis of the power supply.	Chassis ground	
2	+VPROG_ISO	Output Voltage Programming input	0-5V/0-10V	4-20mA
3	+IPROG_ISO	Output Current Programming input	0-5V/0-10V	4-20mA
4	GND_ISO	Ground for programming signals.	Ground	Ground
5	GND_ISO	Ground for programming signals.	Ground	Ground
6	+VMON_ISO	Output Voltage Monitoring output	0-5V/0-10V	4-20mA
7	+IMON_ISO	Output Current Monitoring output	0-5V/0-10V	4-20mA
8	SHLD	Shield, connected internally to chassis of the power supply.	Chassis ground	

## 9.4. Setup and Operating Instructions

### CAUTION

To prevent damage to the unit, do not program the Output voltage and Output current to higher than the power supply ratings.

#### 9.4.1. Setting up the power supply for 0-5V/0-10V Isolated Programming and Monitoring

Perform the following procedure to configure the power supply.

- a) Turn the power supply AC power switch to Off.
- b) Connect a wire jumper between J1-8 and J1-12 (refer to Table 4-4).
- c) Set the Setup switch SW1-1 and -2 to their UP position.
- d) Set SW1-3 to select the programming voltage range: Down=0-5V, Up=0-10V.
- e) Set SW1-4 to select the monitoring range: Down=0-5V, Up=0-10V.
- f) Ensure that SW1-7 and -8 are in their DOWN position.
- g) Connect the programming sources to the mating plug of the Isolated Programming connector. Observe for correct polarity of the voltage source.

### NOTE

*J1-8 and J1-12 must be shorted together with a wire jumper.*

- h) Set the programming sources to the desired levels and turn the power supply ON.

#### 9.4.2. Setting up the power supply for 4-20mA Isolated Programming and Monitoring

Perform the following procedure to configure the power supply:

- a) Turn the power supply AC power switch to Off.
- b) Connect a wire jumper between J1-8 and J1-12 (refer to Table 4-4).
- c) Set the Setup switch SW1-1 and -2 to their Up position.
- d) Set SW1-3 to its UP position.
- e) Set SW1-4 to its UP position.
- f) Ensure that SW1-1 and -2 to their UP position.
- g) Connect the programming source to the mating plug of the Isolated Programming connector. Observe for correct polarity of the current source.

### NOTE

*J1-8 and J1-12 must be shorted together with a jumper.*

- h) Set the programming sources to the desired levels and turn the power supply ON.

### CAUTION

When the Isolated Analog Option is installed, do not apply any signals to the non-isolated VPGM and IPGM (J1-9 and J1-10) pins. All other J1 connector features may be used normally. Refer to Section 4.5 for a description of J1 connector features.

### NOTE

*SW1-3 and -4 must be in their UP position for operation with 4-20mA Isolated Programming and Monitoring.*

## **10. MAINTENANCE**

---

### **10.1. Introduction**

This Chapter provides information about maintenance, calibration and troubleshooting.

### **10.2. Units Under Warranty**

Units requiring repair during the warranty period should be returned to a TDK-Lambda Americas Inc. Authorized Service Facility. Refer to the addresses listing on the back cover of this user manual. Unauthorized repairs performed by other than the Authorized Service Facilities will void the warranty.

### **10.3. Periodic Maintenance**

No routine maintenance of the power supply is required except for periodic cleaning. To clean, disconnect the unit from the AC power source and allow 60 seconds for discharging internal voltage. The front panel and the metal surfaces should be cleaned using a damp cloth containing a mild solution of detergent and water. The solution should be applied onto a soft cloth, and not directly to the surface of the unit. Do not use aromatic hydrocarbons or chlorinated solvents for cleaning. Use low pressure compressed air to blow dust from the unit.

### **10.4. Adjustments and Calibration**

No internal adjustment or calibration is required. There is NO REASON to open the power supply cover. This will void the warranty.

### **10.5. Parts Replacement and Repairs**

As repairs are made only by the manufacturer or by Authorized Service Facilities, no parts replacement information is provided in this User's Manual. In case of failure, unusual or erratic operation of the unit, contact a TDK-Lambda Americas Inc. Sales or Authorized Service Facility nearest you. Please refer to the TDK-Lambda Americas Inc. Sales Offices addresses listing on the back cover of this user manual.

### **10.6. Troubleshooting**

If the Power Supply appears to be operating improperly, use the troubleshooting guide to determine whether the power supply, load or external control circuit are the cause.

Configure the power supply for basic front panel operation and perform the tests of Section 0 to determine if the problem is with the power supply.

Table 10-1 provides the basic checks that can be performed to diagnose problems, and references to Sections of this manual for further information.



**Table 10-1: Troubleshooting Guide**

<b>SYMPTOM</b>	<b>CHECK</b>	<b>ACTION</b>	<b>REF</b>
No output. All displays and indicators are blank.	Is the AC power cord defective?	Check continuity, replace if necessary.	3.7
	Is the AC input voltage within range?	Check AC input voltage. Connect to appropriate voltage source.	3.6 3.7
Output is present momentarily but shuts off quickly. The display indicates "AC".	Does the AC source voltage sag when load is applied?	Check AC input voltage. Connect to appropriate voltage source.	3.6
Output is present momentarily but shuts off quickly. The display indicates "OUP".	Is the power supply configured to Remote sense?	Check if the positive or negative load wire is loose.	3.9.8 3.10.3
Output voltage will not adjust. Front panel CC LED is on.	Is the unit in constant current mode?	Check current limit setting and load current.	5.2.1 5.2.2
Output voltage will not adjust Front panel CV Led is on.	Check if output voltage is adjusted above OVP setting or below UVL setting.	Set OVP or UVL so they will not limit the output.	5.3 5.4
Output current will not adjust. Front panel CV LED is on.	Is the unit in constant voltage mode?	Check current limit and voltage setting	5.2.1 5.2.2
Large ripple present in output.	Is the power supply in remote sense? Is the voltage drop on the load wire high?	Check load and sense wires connection for noise and impedance effects. Minimize the drop on the load wires.	3.9.2 3.9.5 3.10.3
No output. Display indicates "OUP"	Over Voltage Protection circuit is tripped.	Turn Off the AC power switch. Check load connections. If analog programming is used, check if the OVP is set lower than the output.	5.3
No output. Front panel ALARM LED is blinking.	Display indicates "ENA"	Check rear panel J1 ENABLE connection. Setup SW1 switch setting.	5.8 5.8
	Display indicates "SO"	Check rear panel J1 Output Shut-Off connection.	5.7
	Display indicates "OTP"	Check if air intake or exhaust are blocked. Check if the unit is installed adjacent to heat generating equipment.	1.2.7 3.5 5.13
	Display indicates "Fb"	Check Foldback setting and load current.	5.5
Poor Load regulation. Front panel CV LED is on.	Are sensing wires connected properly?	Connect the sense wires according to User's Manual instructions.	3.9 3.10.3
The front panel controls are nonfunctional.	Is the power supply in Local-Lockout mode?	Turn Off the AC power and wait until the display turns off. Turn On the AC power and press front panel REM/LOC button.	5.12 8.2.5

THIS IS A COMPUTER GENERATED DWG.  
NO MANUAL REVISIONS ARE PERMITTED.

LTR	E.C.O. NO.	BY	APP.
1	INITIAL RELEASE	10/7/14	HP
2	TO CHANGE	12/5/14	HP
A	REL TO MFG REV2 = REVA	1/21/15	HP

MOUNTING FOR SLIDE MOUNTS (NOT INCLUDED)  
RECOMMENDED CHASSIS SLIDE MANUFACTURER:  
GENERAL DEVICES CHASSIS TRAK P/N C230-S-122  
SECURE WITH PAN HEAD SCREW M5x0.8-8mm LG MAX

TOP VIEW  
O/P SHROUD REMOVED FOR CLARITY

RIGHT SIDE VIEW  
O/P SHROUD REMOVED FOR CLARITY

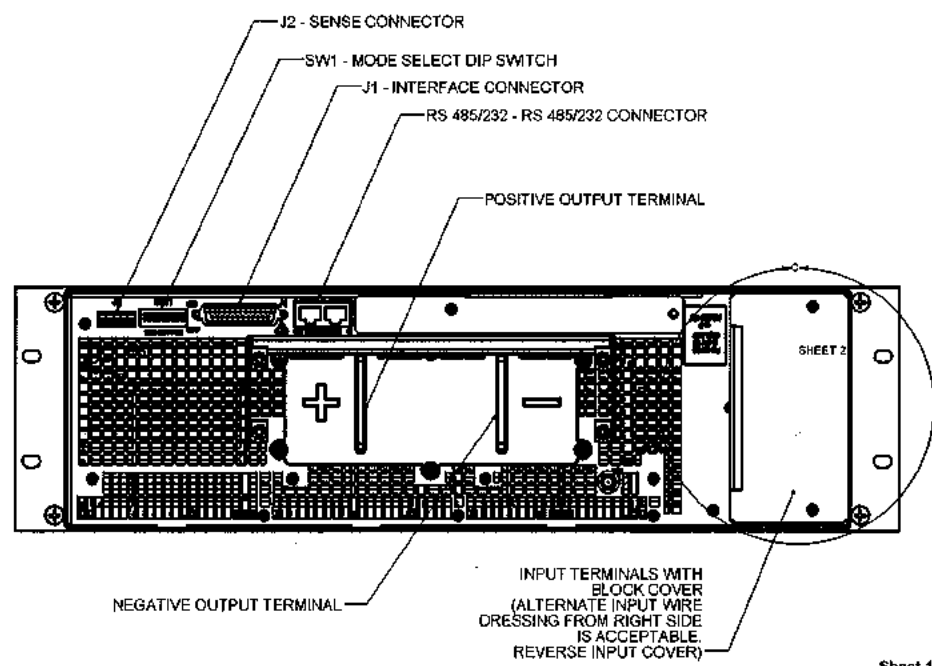
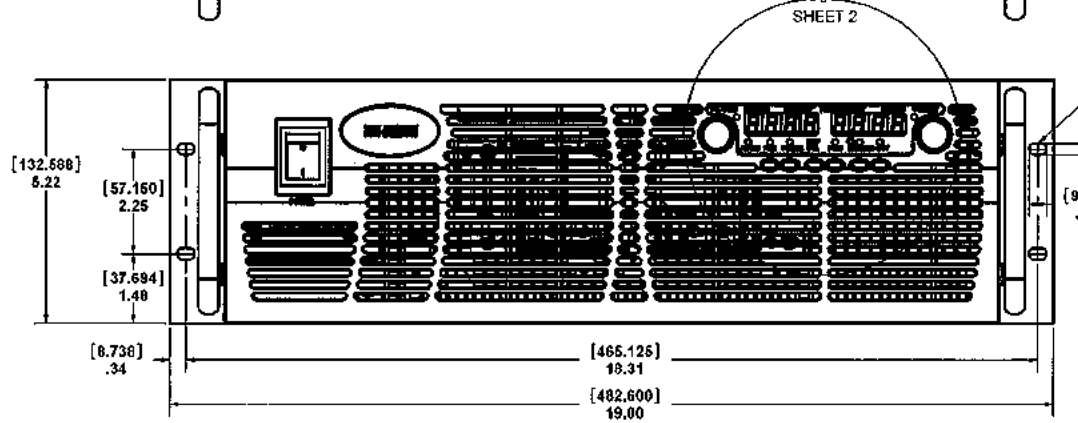
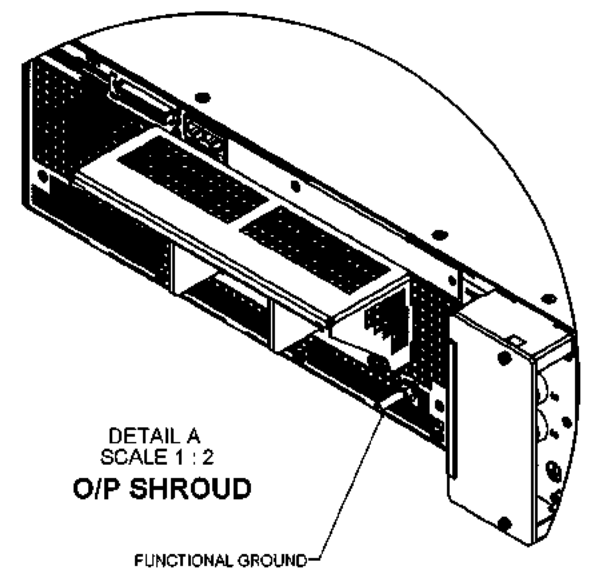
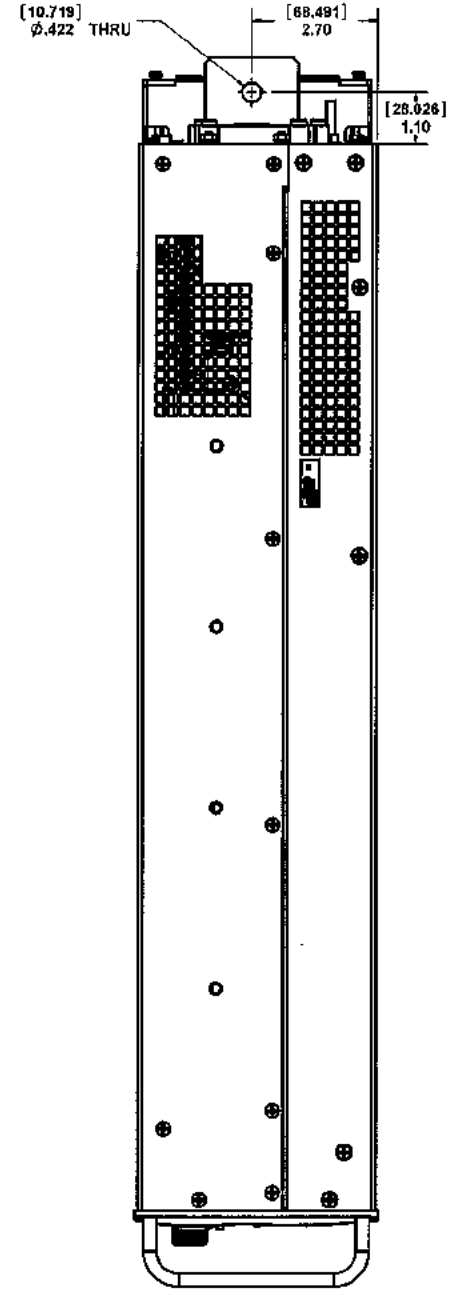
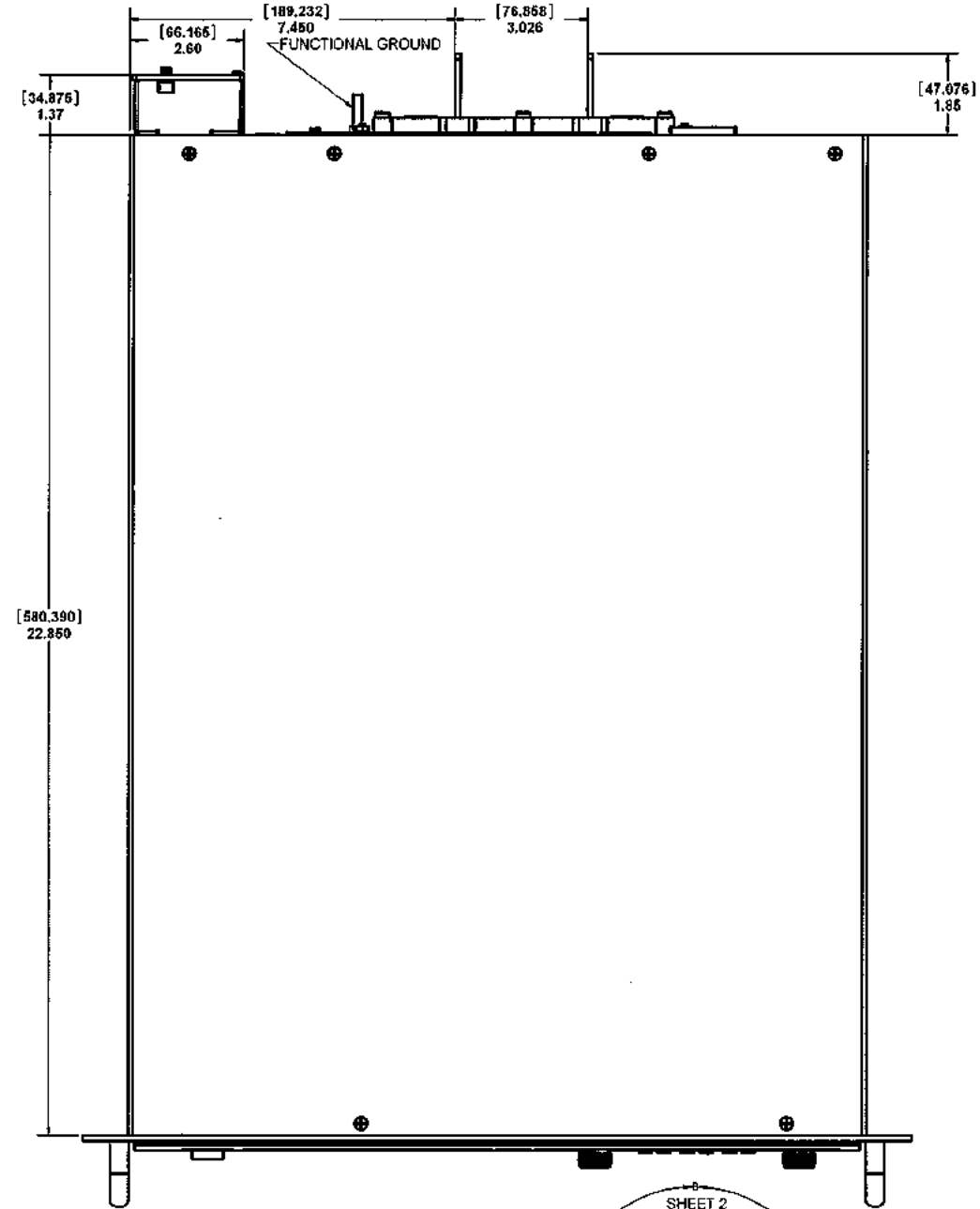
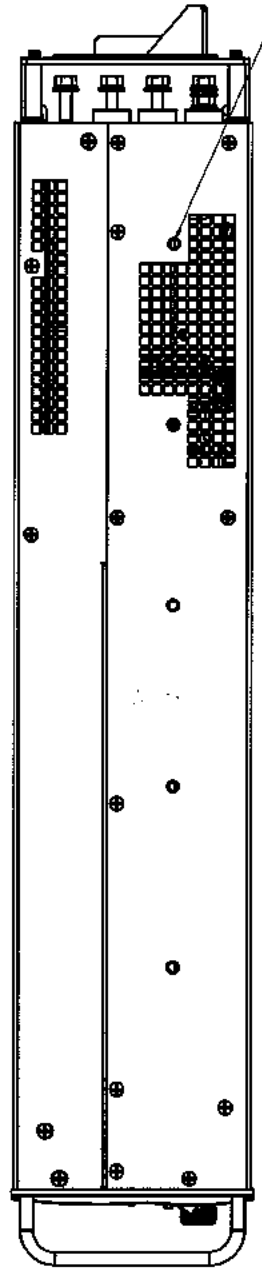

DIMENSIONS IN BRACKETS [ ] ARE METRIC EQUIVALENT IN MILLIMETERS.  
SOLIDWORKS DRAWING.  
THIS IS A STANDARD FORMAT.  
NOT ALL BOXES APPLY TO EVERY DRAWING AND MAY NOT BE FILLED IN.  
Drawing file name: 02532020 GEN 3U PLATFORM A OUTLINE  
Model File name: 00TOP\_005323027-3029

RoHS COMPLIANCE REQUIRED

- NOTES:
- DENOTES ITEMS ON KIT UNIVERSAL PARTS.
  - △ DENOTES VARIABLE PARTS REFERENCED ON MAGNETICS KIT.
  - ⊕ DENOTES TORQUE IN INCH-LBS.
  - USE PROPER AMOUNT OF ITEMS AS CALLED OUT FOR ON BOM.

MTL:	TOL.	REL TO MFG	ENG. CTL.	TITLE
	X = ± .01" (0.254) XX = ± .01" (0.254) XXX = ± .005" (0.127) FRAC. = ± 1/64" (0.0156) ANGLES = ± 1/2°	DATE: 1/21/15 APP: [Signature]	DATE: 1/21/15 APP: [Signature]	DATE: 1/21/15 APP: [Signature]
SCALE: 1:1				

Sheet 1 of 2

TDK-Lambda

OUTLINE, GEN 3U PLATFORM A

02-532-020

THIS IS A COMPUTER GENERATED DWG.  
NO MANUAL REVISIONS ARE PERMITTED.

LTR	E.C.O. NO.	BY	APP.

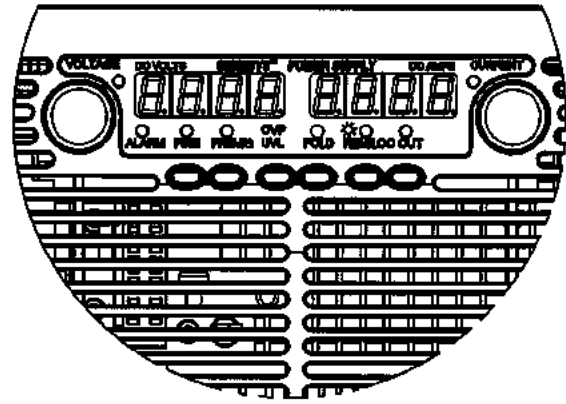

DETAIL B  
DISPLAY / CONTROLS

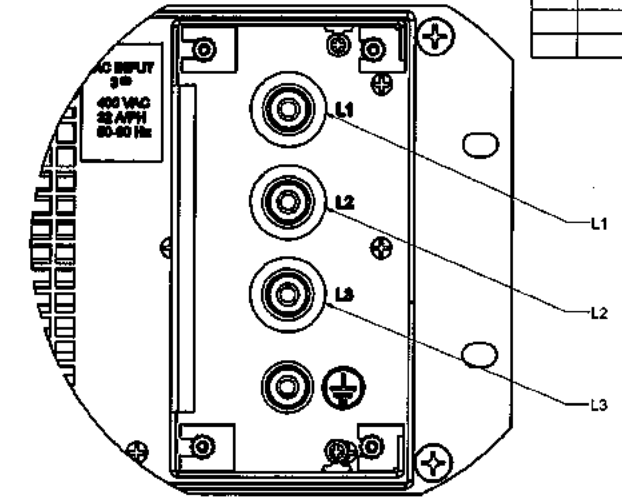

DETAIL C  
AC INPUT TERMINALS  
WITH COVER REMOVED FOR CLARITY

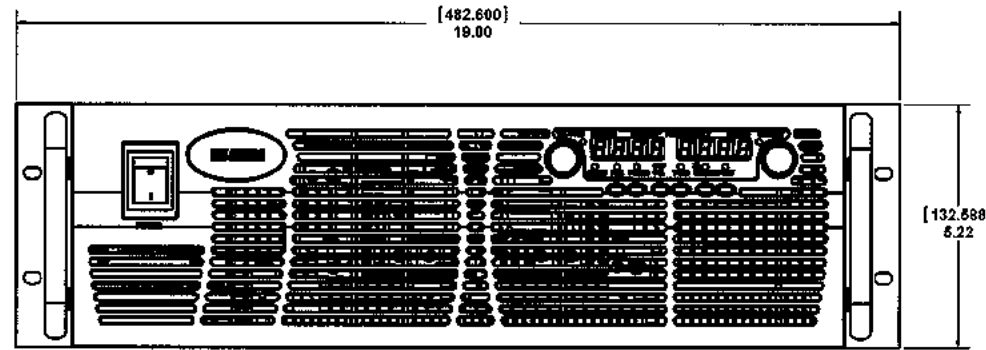

FRONT VIEW

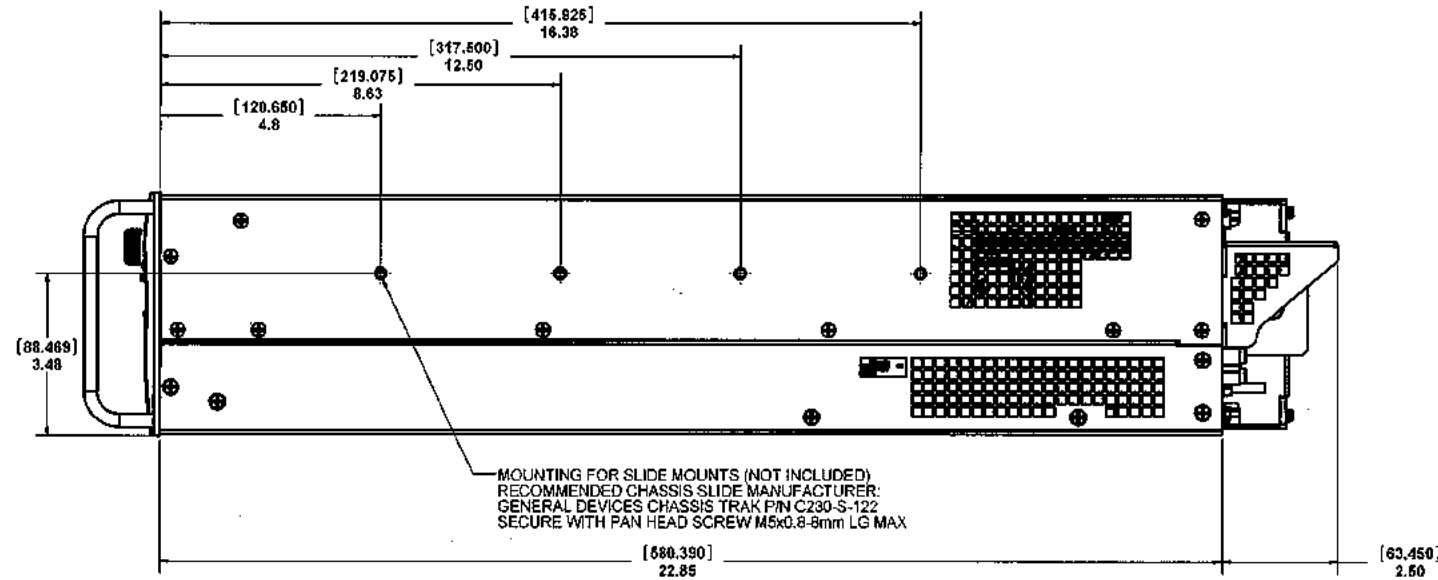

SIDE VIEW

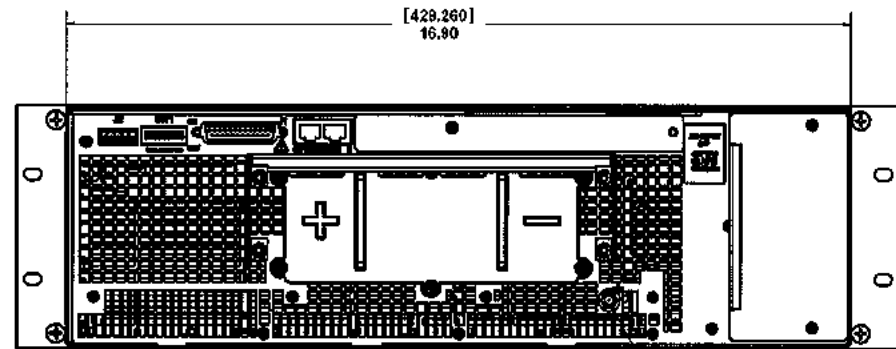

REAR VIEW

FUNCTIONAL GROUND  
M5x0.8 X .91 (23.00) LG THREADED STUD

MOUNTING FOR SLIDE MOUNTS (NOT INCLUDED)  
RECOMMENDED CHASSIS SLIDE MANUFACTURER:  
GENERAL DEVICES CHASSIS TRAK P/N C230-S-122  
SECURE WITH PAN HEAD SCREW M5x0.8-9mm LG MAX

DIMENSIONS IN BRACKETS [ ]  
ARE METRIC EQUIVALENT IN  
MILLIMETERS.

SOLIDWORKS DRAWING.  
THIS IS A STANDARD FORMAT.  
NOT ALL BOXES APPLY TO EVERY  
DRAWING AND MAY NOT BE FILLED IN.

Drawing file name: 02532020 GEN 3U PLATFORM A OUTLINE  
Model File name: 00TOP\_005323027-3029

RoHS COMPLIANCE REQUIRED

NOTES:

- DENOTES ITEMS ON KIT UNIVERSAL PARTS.
- △ DENOTES VARIABLE PARTS REFERENCED ON MAGNETICS KIT.
- ⊖ DENOTES TORQUE IN INCH-LBS.
- USE PROPER AMOUNT OF ITEMS AS CALLED OUT FOR ON BOM.

MFL:	TOL: X = ± .01" (0.254) XX = ± .01" (0.254) XXX = ± .005" (0.127) FRAC. = ± 1/64" (0.391) ANGLES = ± 1/2°	REL. TO MFG:		ENG. CTL:		TDK-Lambda
		PRJ. ENG. DATE:	DWR. DATE:	H. POWELL 1/21/15		
FILE:	SCALE: 1:1	DOC. RFL. DATE:	ENG. DATE:	DATE:	DATE:	TITLE: OUTLINE, GEN 3U PLATFORM A
		FLAT PLAN REL. DATE:	APP. DATE:	DATE:	DATE:	DWG. NO. 02-532-020 REV. A

THIS IS A COMPUTER GENERATED DWG.  
NO MANUAL REVISIONS ARE PERMITTED.

MOUNTING FOR SLIDE MOUNTS (NOT INCLUDED)  
RECOMMENDED CHASSIS SLIDE MANUFACTURER:  
GENERAL DEVICES CHASSIS TRAK P/N C230-S-122  
SECURE WITH PAN HEAD SCREW M5x0.8-8mm LG MAX

TOP VIEW  
O/P SHROUD REMOVED FOR CLARITY

RIGHT SIDE VIEW  
O/P SHROUD REMOVED FOR CLARITY

LTR	E.C.O. NO.	BY	APP.
1	INITIAL RELEASE	08/25/15	OM
A	REL TO MFG REV1=REVA	08/25/15	OM

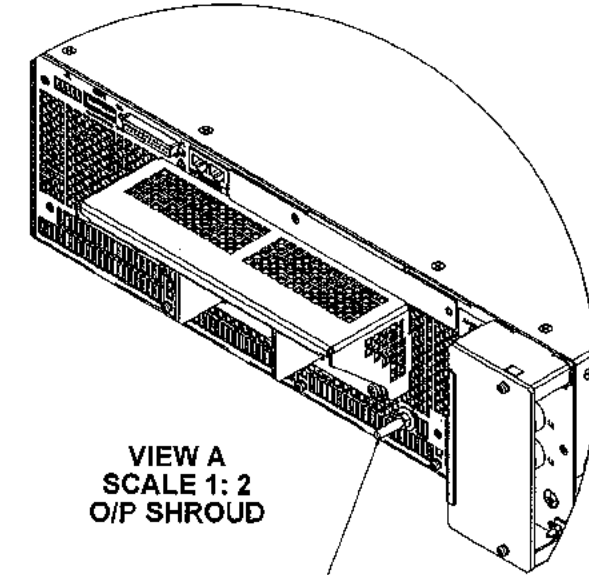
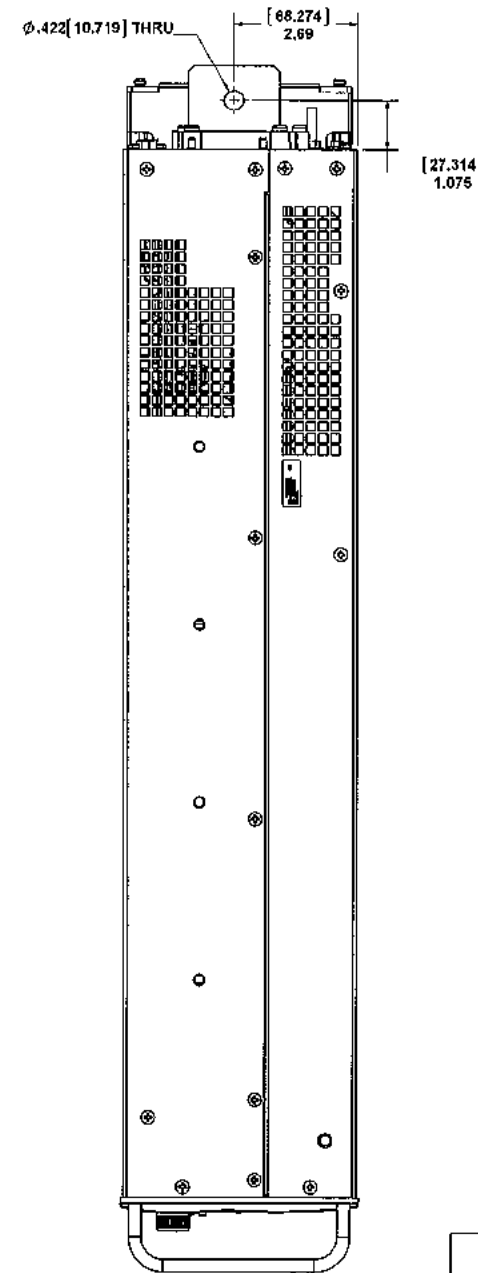
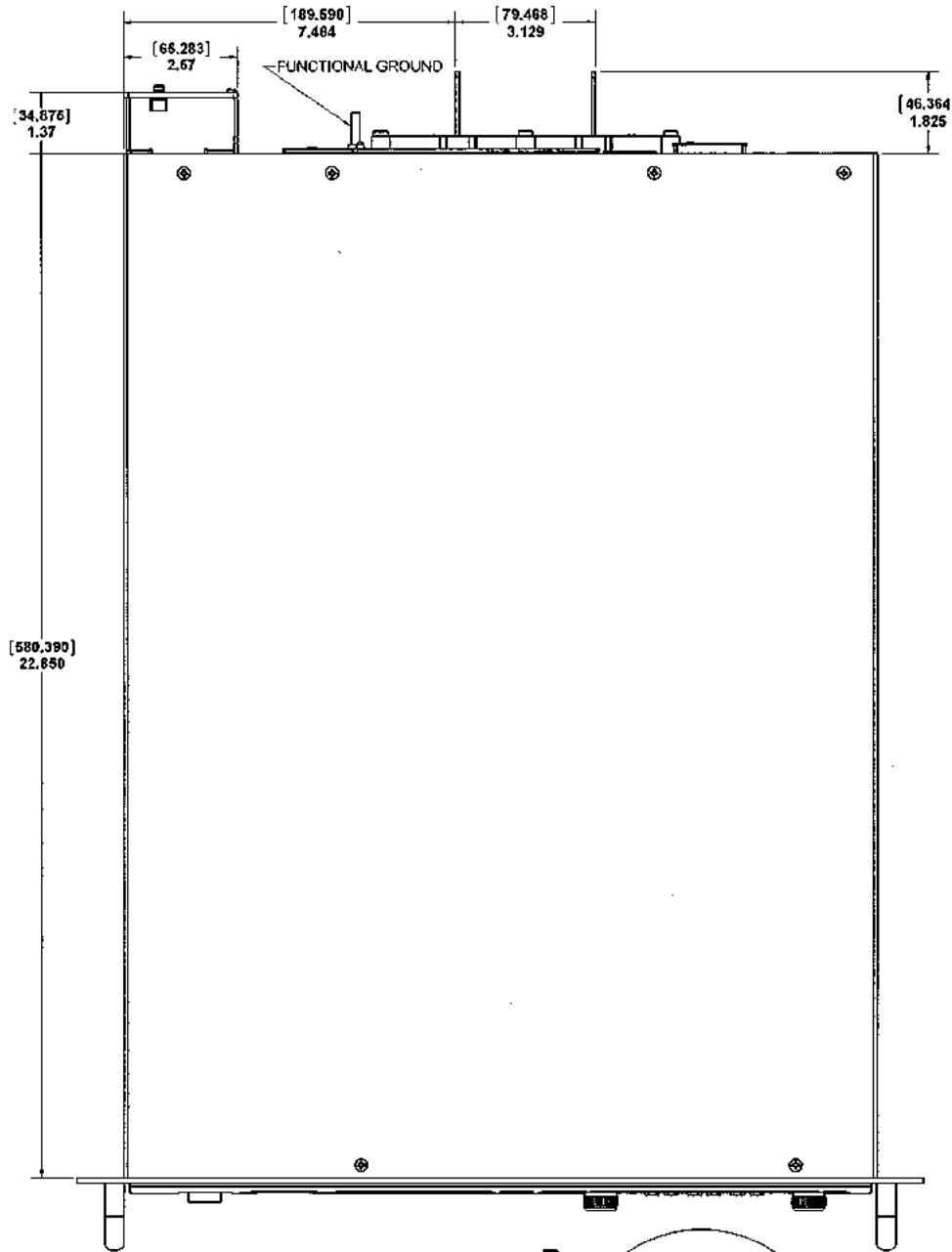
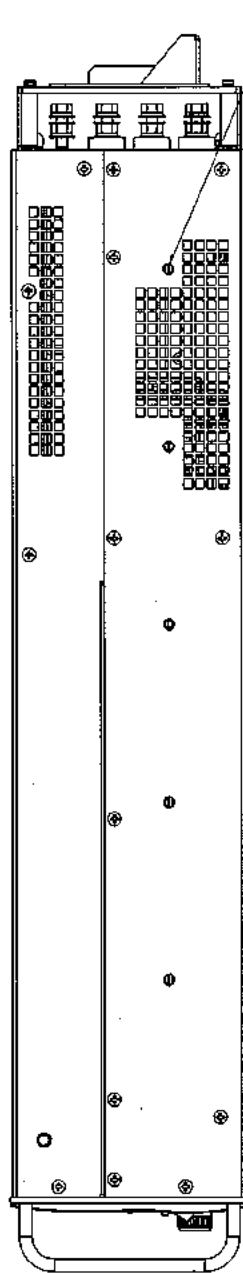

VIEW A  
SCALE 1: 2  
O/P SHROUD

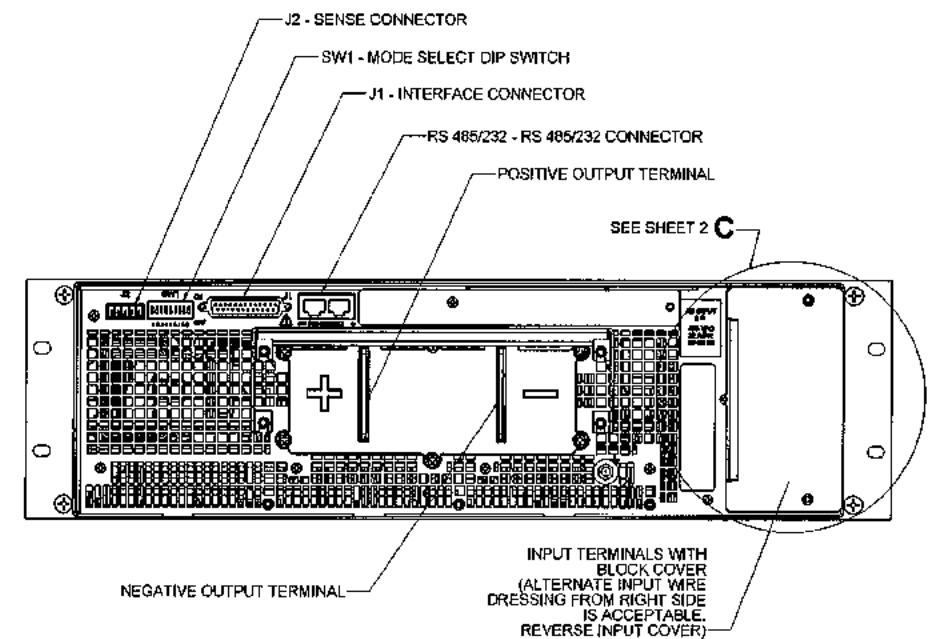
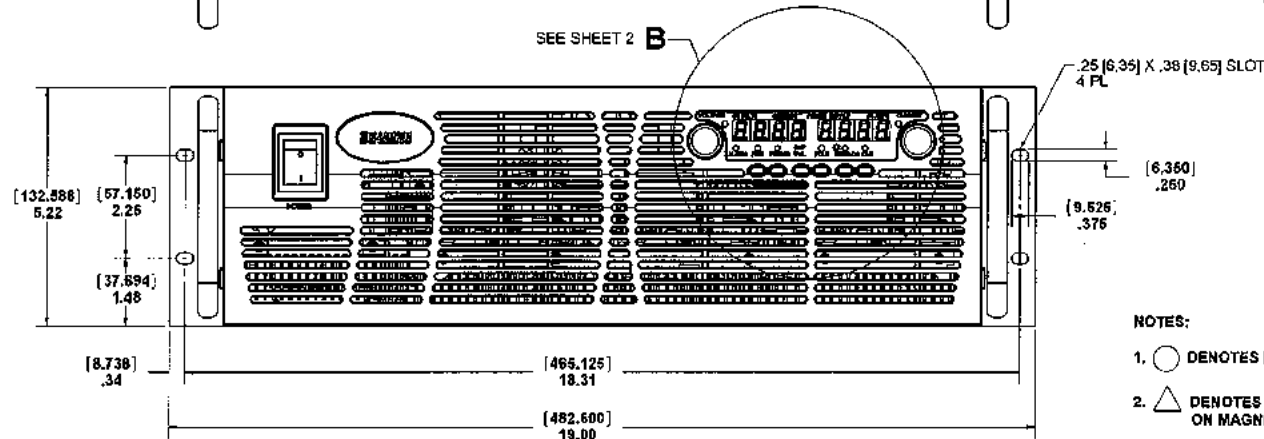

DIMENSIONS IN BRACKETS [ ]  
ARE METRIC EQUIVALENT IN  
MILLIMETERS.  
SOLIDWORKS DRAWING.  
THIS IS A STANDARD FORMAT.  
NOT ALL BOXES APPLY TO EVERY  
DRAWING AND MAY NOT BE FILLED IN.  
Drawing file name: 02632021  
Model file name: 00TOP\_0083230XX-B

RoHS COMPLIANCE REQUIRED

- NOTES:
- DENOTES ITEMS ON KIT UNIVERSAL PARTS.
  - △ DENOTES VARIABLE PARTS REFERENCED ON MAGNETICS KIT.
  - ⊙ DENOTES TORQUE IN INCH-LBS.
  - USE PROPER AMOUNT OF ITEMS AS CALLED OUT FOR ON BOM.

MTL	TOL	REL TO MFG	ENG. CTL	DATE	DATE	DATE	DATE	TITLE
	X = .02 [0.508] XX = .01 [0.254] XXX = .005 [0.127] FRAG = 1/2 ANGLED = 1/2	REL TO MFG	DATE: 06/28/16	DATE: 06/28/16	DATE: 06/28/16	DATE: 06/28/16	DATE: 06/28/16	DATE: 06/28/16
FIN	PL 532	SCALE 1:1	DATE: 08/26/15	DATE: 08/26/15	DATE: 08/26/15	DATE: 08/26/15	DATE: 08/26/15	DATE: 08/26/15

Sheet 1 of 2

**TDK-Lambda**  
OUTLINE, GEN 3U,  
PLATFORM B  
02-632-021

THIS IS A COMPUTER GENERATED DWG.  
NO MANUAL REVISIONS ARE PERMITTED.

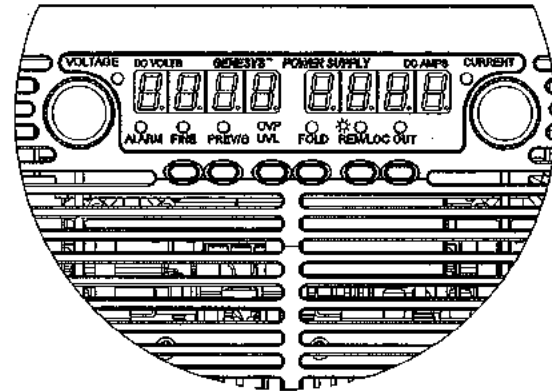

DETAIL B

DISPLAY / CONTROLS

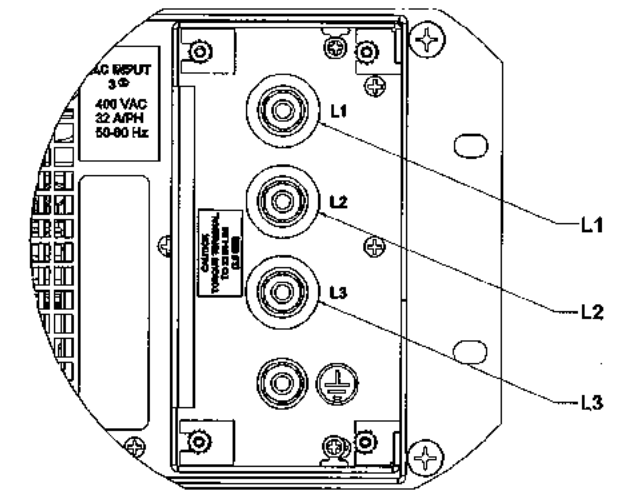

DETAIL C

AC INPUT TERMINALS  
WITH COVER REMOVED FOR CLARITY

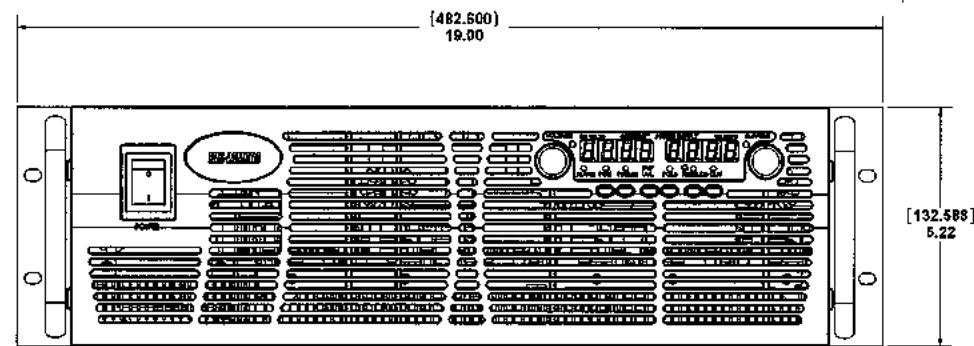

FRONT VIEW

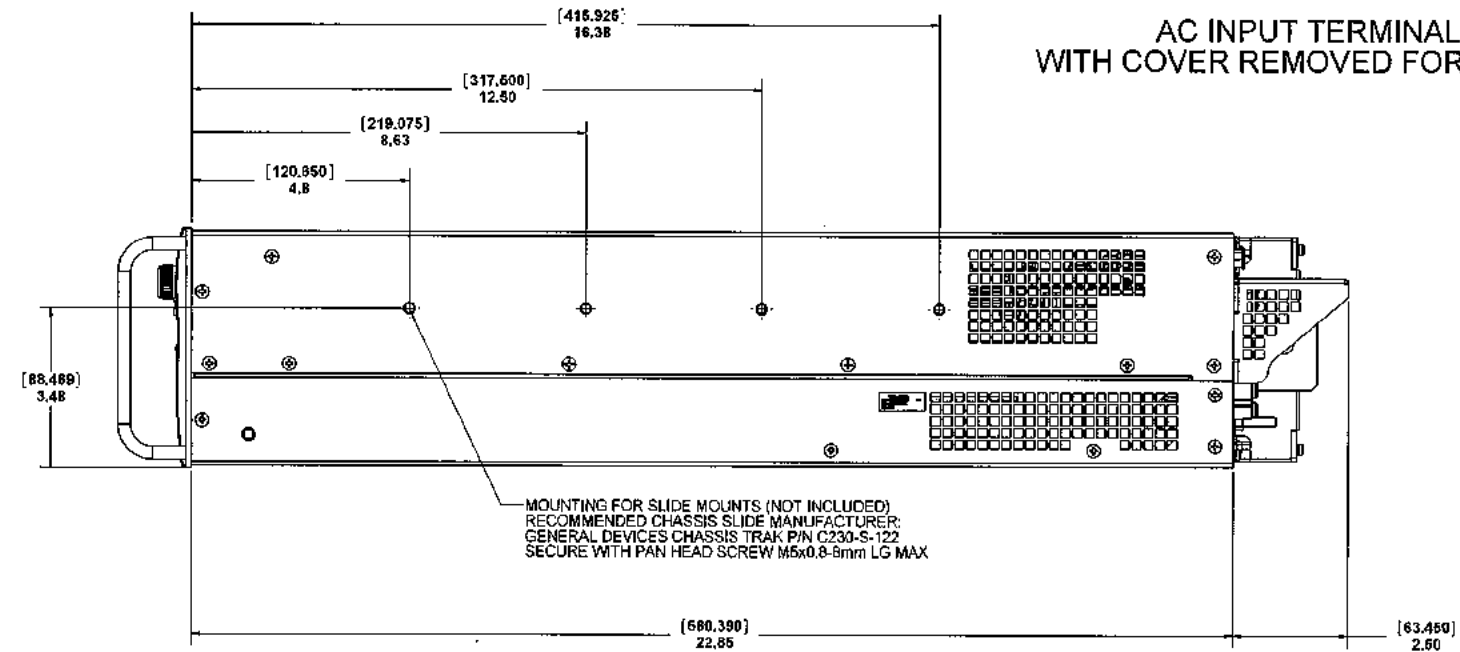

SIDE VIEW

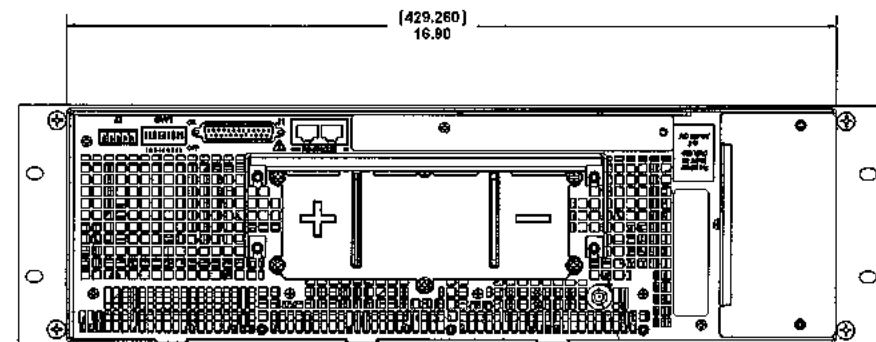

REAR VIEW

FUNCTIONAL GROUND  
M5x0.8 X .91 [23.00] LG THREADED STUD

DIMENSIONS IN BRACKETS [ ]  
ARE METRIC EQUIVALENT IN  
MILLIMETERS.

SOLIDWORKS DRAWING.  
THIS IS A STANDARD FORMAT.  
NOT ALL BOXES APPLY TO EVERY  
DRAWING AND MAY NOT BE FILLED IN.

Drawing file name: 02532021

Model file name: 00TOP\_0053230XX-B

RoHS COMPLIANCE REQUIRED

NOTES:

- DENOTES ITEMS ON KIT UNIVERSAL PARTS.
- △ DENOTES VARIABLE PARTS REFERENCED ON MAGNETICS KIT.
- ⊙ DENOTES TORQUE IN INCH-LBS.
- USE PROPER AMOUNT OF ITEMS AS CALLED OUT FOR ON BOM.

Sheet 2 of 2

MTL	TOL	REL TO MFG	ENG. CTL	TITLE	
	X = ± .02 [0.508] XX = ± .01 [0.254] XXX = ± .005 [0.127] FRS = ± .004 [0.101] ANGLES = 1/2°	PRJ. ENG. DATE: DWN. DATE: CHK. DATE:	06/26/15	TDK-Lambda	
PRJ.	632	DOC. REL. DATE: ENG. DATE: FLAT PLAN REL. DATE: APP. DATE:	08/26/15	OUTLINE, GEN 3U, PLATFORM B	
	SCALE: 1:1			DWG. NO. 02-532-021	REV. A

THIS IS A COMPUTER GENERATED DWG.  
NO MANUAL REVISIONS ARE PERMITTED.

MOUNTING FOR SLIDE MOUNTS (NOT INCLUDED)  
RECOMMENDED CHASSIS SLIDE MANUFACTURER:  
GENERAL DEVICES CHASSIS TRAK P/N C230-S-122  
SECURE WITH PAN HEAD SCREW M5x0.8-9mm LG MAX

TOP VIEW  
O/P SHROUD REMOVED FOR CLARITY

RIGHT SIDE VIEW  
O/P SHROUD REMOVED FOR CLARITY

LTR	E.C.O. NO.	BY	APP.
1	INITIAL RELEASE	06/25/15	DM
A	REL TO MFG REV1-REVA	06/25/15	DM
B	ECOP# 27202	11/20/15	VLB

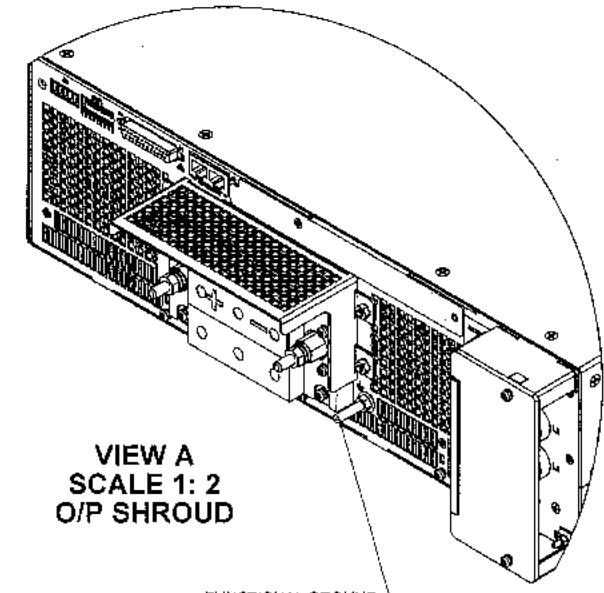
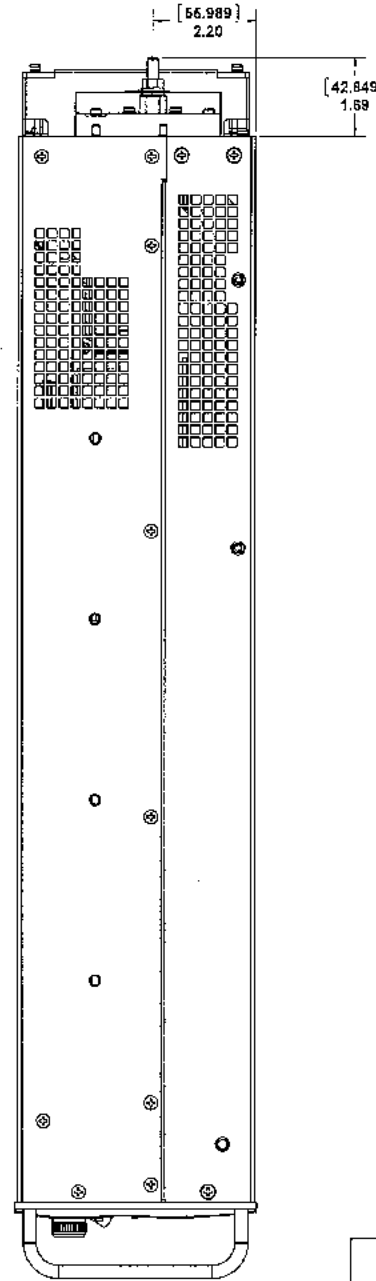
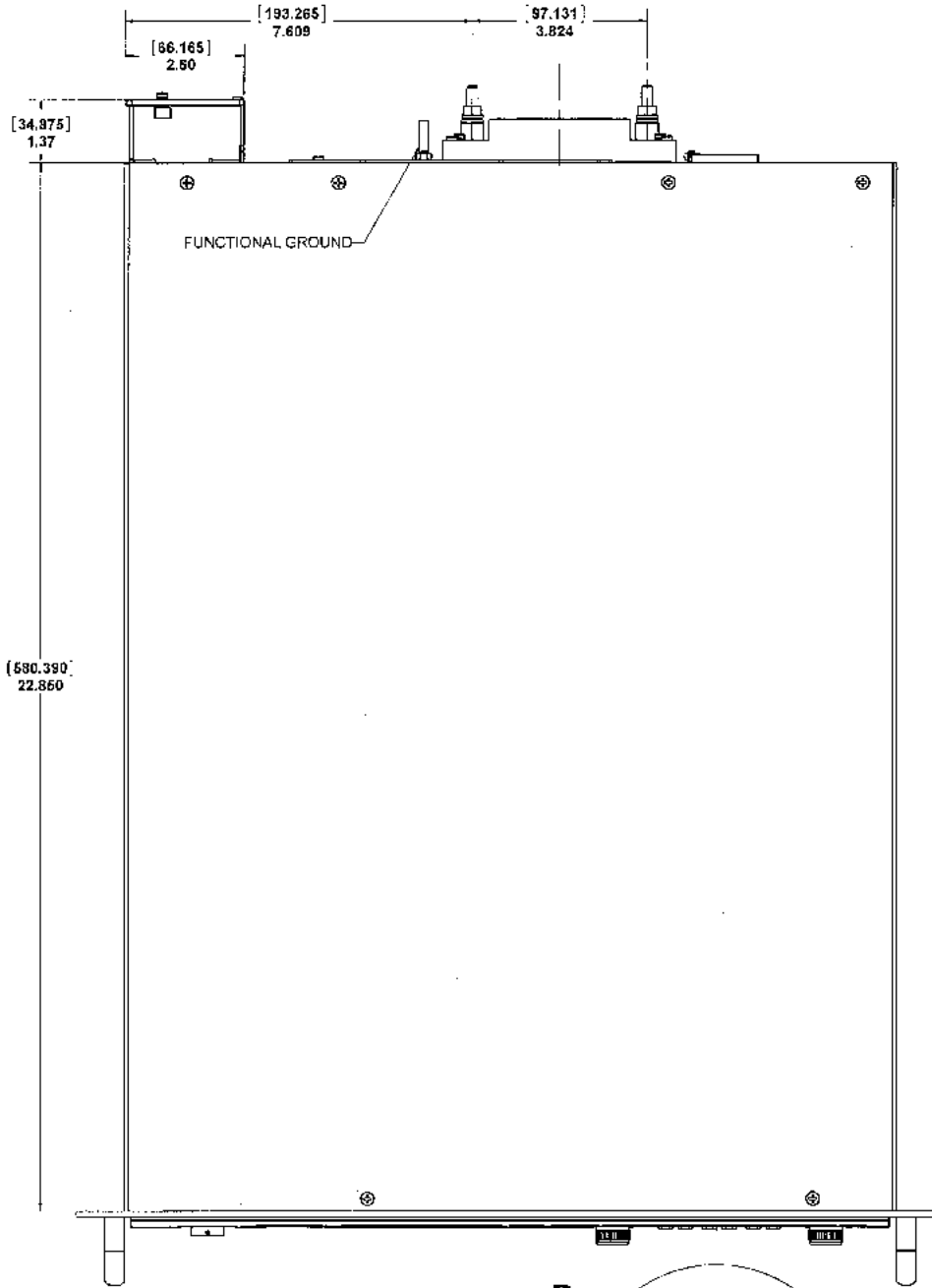
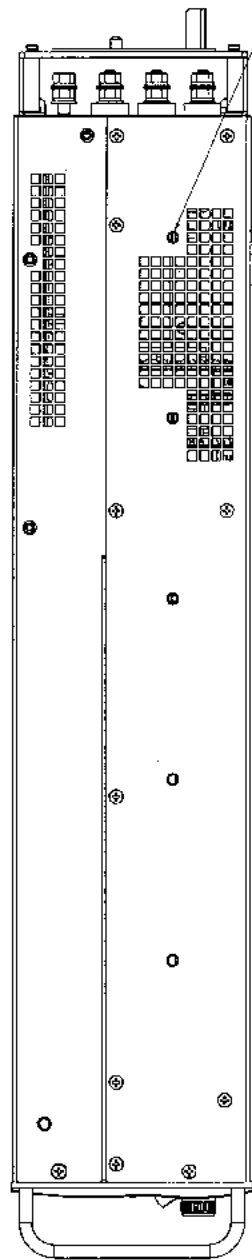

VIEW A  
SCALE 1: 2  
O/P SHROUD

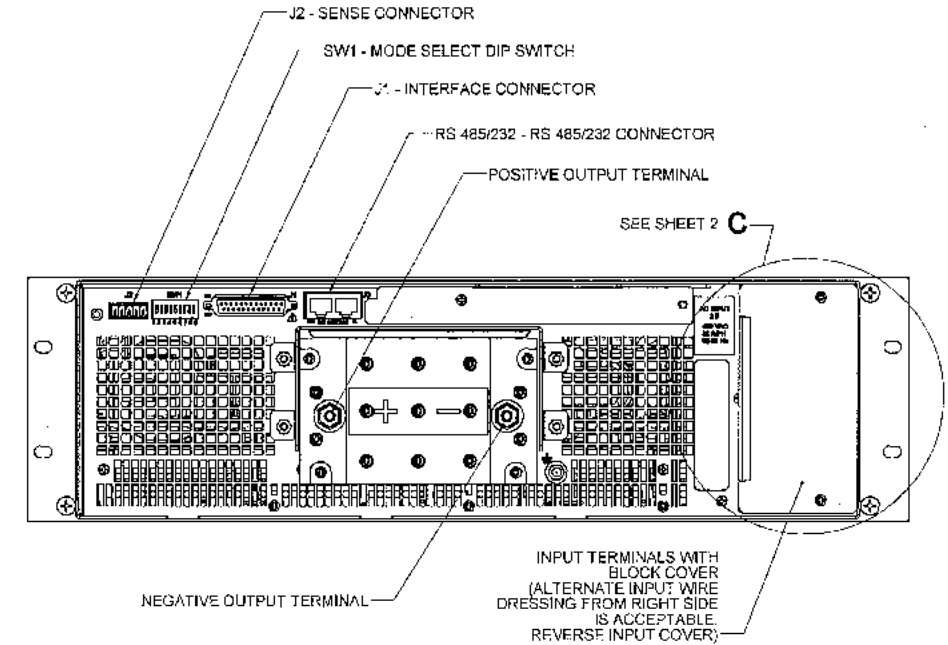
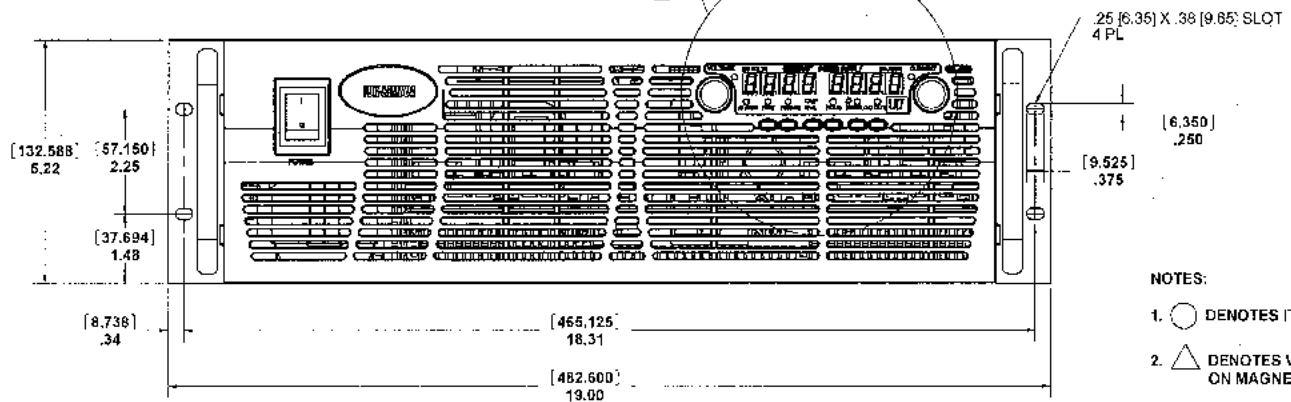

DIMENSIONS IN BRACKETS [ ]  
ARE METRIC EQUIVALENT IN  
MILLIMETERS.  
SOLIDWORKS DRAWING.  
THIS IS A STANDARD FORMAT.  
NOT ALL BOXES APPLY TO EVERY  
DRAWING AND MAY NOT BE FILLED IN.  
Drawing file name: 02532022  
Model File name: 00TOP\_0053230XX-C-092215

- NOTES:
- DENOTES ITEMS ON KIT UNIVERSAL PARTS.
  - △ DENOTES VARIABLE PARTS REFERENCED ON MAGNETICS KIT.
  - ⊙ DENOTES TORQUE IN INCH-LBS.
  - USE PROPER AMOUNT OF ITEMS AS CALLED OUT FOR ON BOM.

RoHS COMPLIANCE REQUIRED

MTL	TOL	REL TO MFG	ENG_CTL	TDK-Lambda
	X = ± .02 [0.508] Y = ± .01 [0.254] Z = ± .005 [0.127] FRAC = ± 1/64 [0.381] ANGLES = 1/12°	FR. ENG. DATE 12/15/15	DATE 12/15/15	OUTLINE, GEN 3U, PLATFORM C
FIN:	PRI: 532	DOC. RFL DATE 12/15/15	DATE 12/15/15	REV. B
	SCALE: 1:1	PLAT PLAN REL. DATE	APP.	DWG. NO. 02-632-022

THIS IS A COMPUTER GENERATED DWG.  
NO MANUAL REVISIONS ARE PERMITTED.

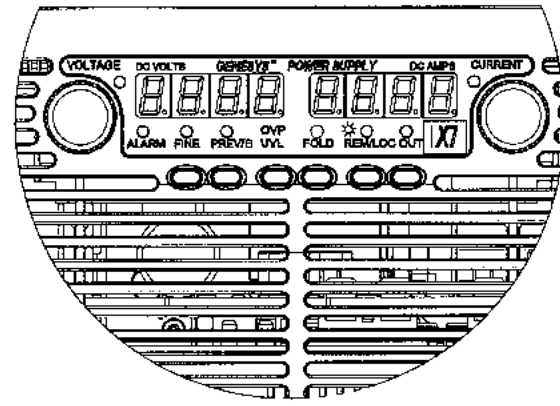

DETAIL B

DISPLAY / CONTROLS

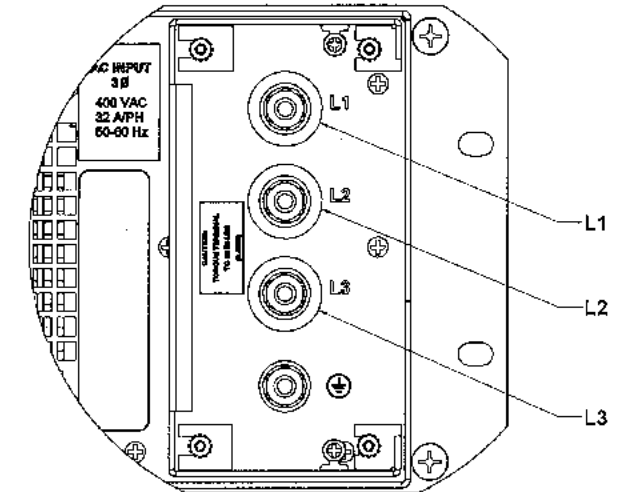

DETAIL C

AC INPUT TERMINALS  
WITH COVER REMOVED FOR CLARITY

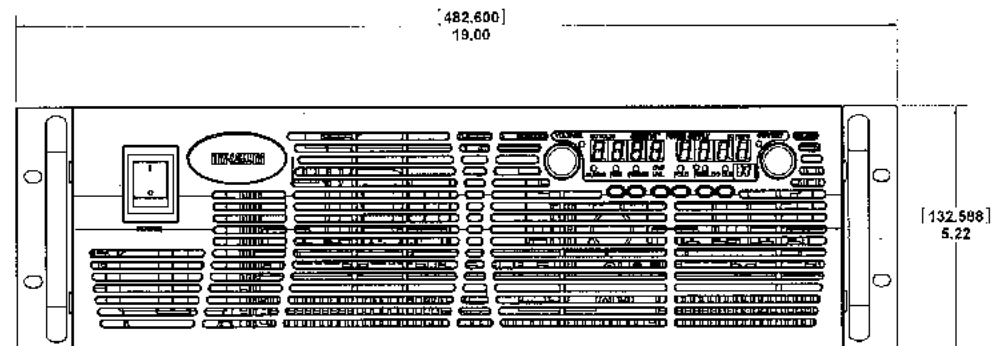

FRONT VIEW

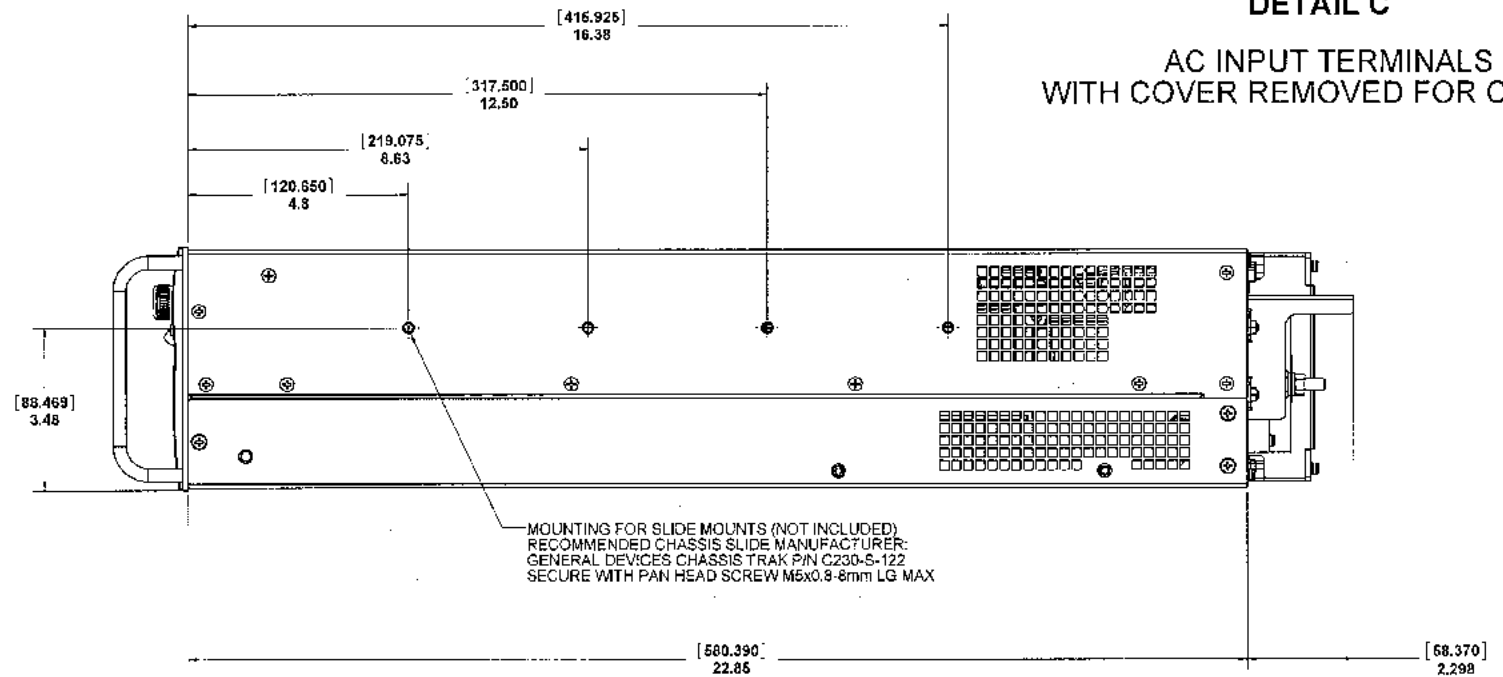

SIDE VIEW

MOUNTING FOR SLIDE MOUNTS (NOT INCLUDED).  
RECOMMENDED CHASSIS SLIDE MANUFACTURER:  
GENERAL DEVICES CHASSIS TRAK P/N C230-S-122  
SECURE WITH PAN HEAD SCREW M6x0.8-8mm LG MAX

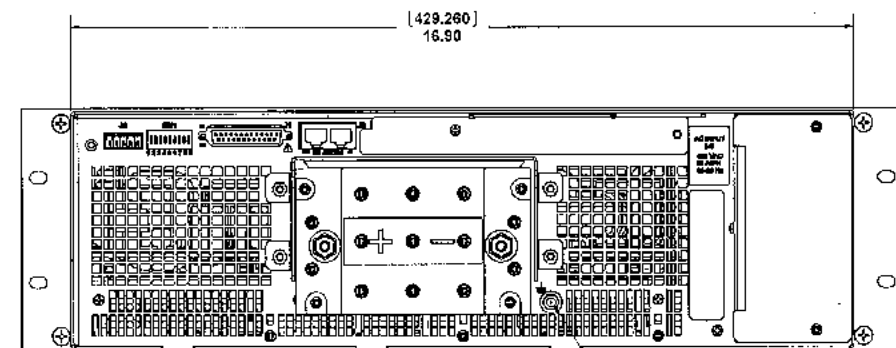

REAR VIEW

FUNCTIONAL GROUND  
M5x0.8 X .91 [23.00] LG THREADED STUD

DIMENSIONS IN BRACKETS [ ]  
ARE METRIC EQUIVALENT IN  
MILLIMETERS.

SOLIDWORKS DRAWING.  
THIS IS A STANDARD FORMAT.  
NOT ALL BOXES APPLY TO EVERY  
DRAWING AND MAY NOT BE FILLED IN.

Drawing file name: 02532022

Model file name: 00TOP\_0053230XX-C-092215

NOTES:

- DENOTES ITEMS ON KIT UNIVERSAL PARTS.
- △ DENOTES VARIABLE PARTS REFERENCED ON MAGNETICS KIT.
- ◇ DENOTES TORQUE IN INCH-LBS.
- USE PROPER AMOUNT OF ITEMS AS CALLED OUT FOR ON BOM.

RoHS COMPLIANCE REQUIRED

MTL:	TOL: X = ± .02" [0.508] XX = ± .01" [0.254] XXX = ± .005" [0.127] FRAC. = 1/16" [0.381] ANGLES = ± 1/2°	REL. TO NEG. DATE:	ENG. OTL. DATE:	TDK-Lambda	
PRJ. LEAD:	532	DATE:	DATE:	TITLE: OUTLINE, GEN 3U, PLATFORM C	
SCALE:	1:1	DOC. REL. DATE:	ENG. DATE:	DWG. NO.:	REV.:
		LAT. PART REL. DATE:	APP. DATE:	02-532-022	B

THIS IS A COMPUTER GENERATED DWG.  
NO MANUAL REVISIONS ARE PERMITTED.

NOTE:  
WITH INPUT TERMINAL BLOCK  
COVER INSTALLED (DETAIL B).

NOTE: OUTPUT TERMINAL COVERS  
NOT SHOWN IN TOP AND REAR VIEW  
FOR CLARITY.

LTR	E.C.O. NO.	BY	APP.
1	INITIAL RELEASE		
2	UPDATE DIMS AND NOTES		
3	REMOVE ENCAPSULATED REF. FROM TITLE BLOCK		
A	T/G REL. REV J = REV A	LWR	TR
B	ECO#27202	YLB	

MOUNTING FOR  
SLIDE MOUNTS  
(NOT INCLUDED)  
RECOMMENDED  
CHASSIS SLIDE  
MANUFACTURE:  
GENERAL DEVICES  
CHASSIS TRAK  
P/N C230-S-122  
SECURE WITH  
PAN HEAD SCREW  
M5x0.8-8mm LONG  
MAX.

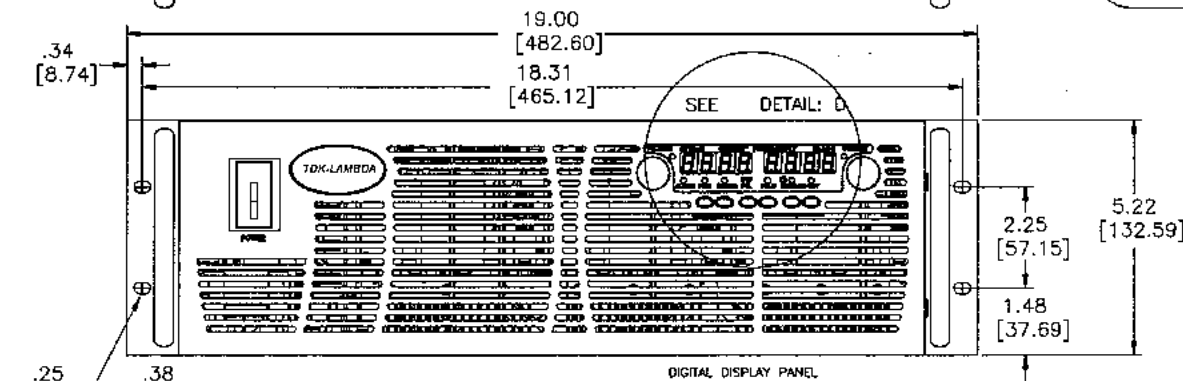
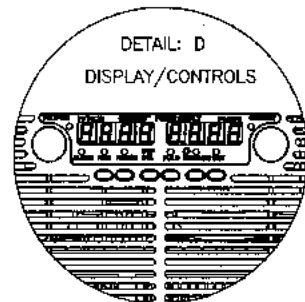
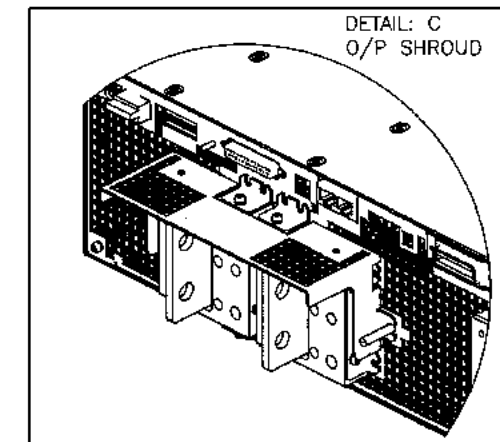
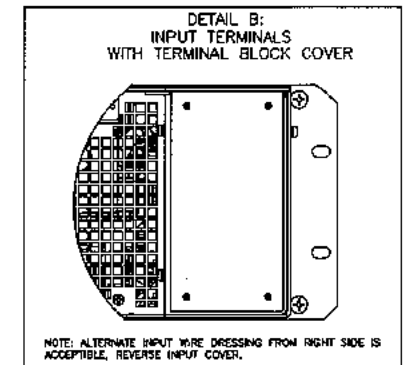
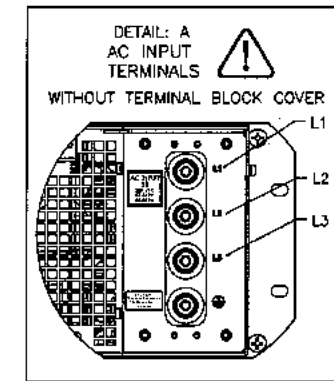
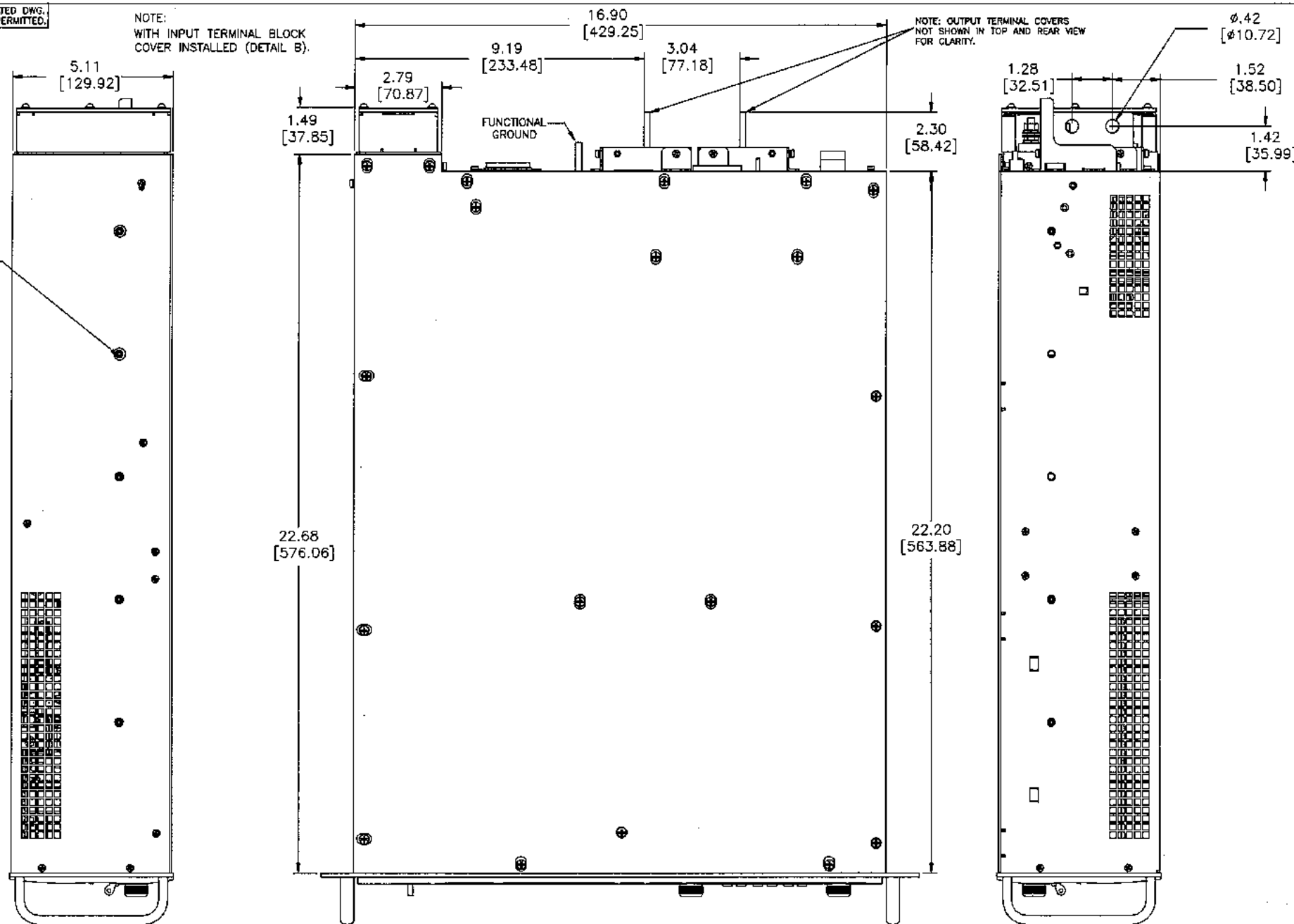

PRODUCT DIMENSIONS		
PANEL SIZE	LENGTH WITH TERMINALS AND WITHOUT I/O COVERS	WIDTH BEHIND PANELS
[132.59] [482.60] 5.22" HEIGHT x 19" WIDTH	[522.30] 24.50	[429.26] 16.90

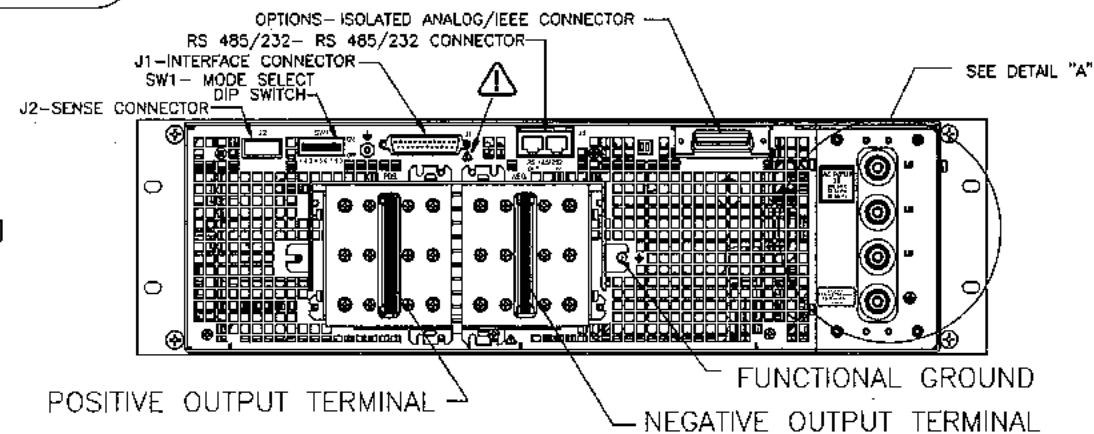

ISO/CAD DRAWING  
THIS IS A STANDARD FORMAT.  
NOT ALL BOXES APPLY TO EVERY  
DRAWING AND MAY NOT BE FILLED IN.

DIMENSIONS WITH BRACKETS [ ]  
ARE METRIC EQUIVALENT  
IN MILLIMETERS.

MTL	REL. TO MFG.	ENG. CTL.	TITLE
	ENG. DATE: 12/15/85	DATE: 12/15/85	TDK-Lambda
FIN	PAL 530	DO NOT SCALE ENG.	DIM OUTLINE GEN 3U PLATFORM A STD
	SCALE: NONE		DWG. NO. 02-530-000

SHEET 1 OF 6



THIS IS A COMPUTER GENERATED DWG.  
NO MANUAL REVISIONS ARE PERMITTED.

LTR	E.C.G. NO.	BY	APP.
	SEE SHEET ONE		

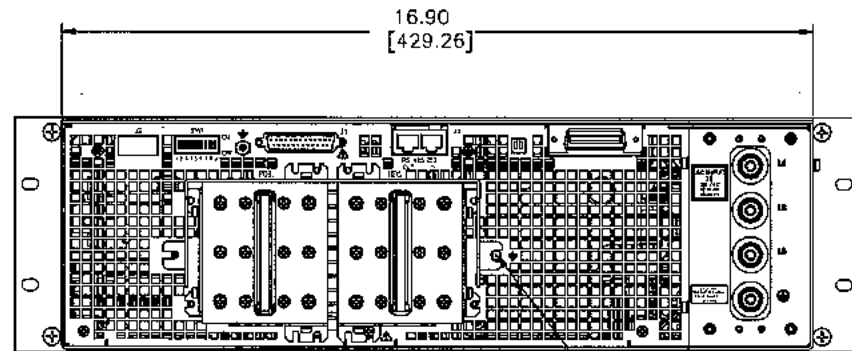
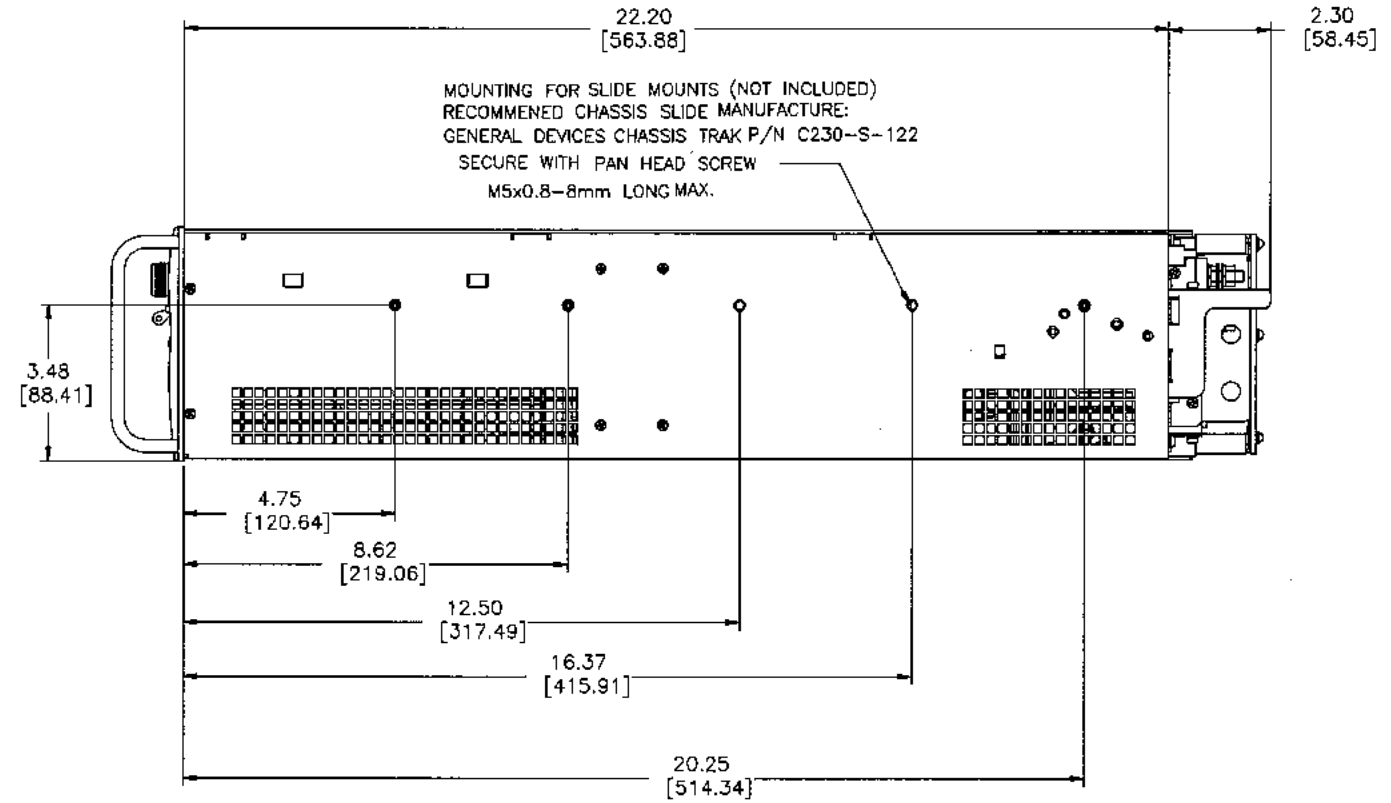
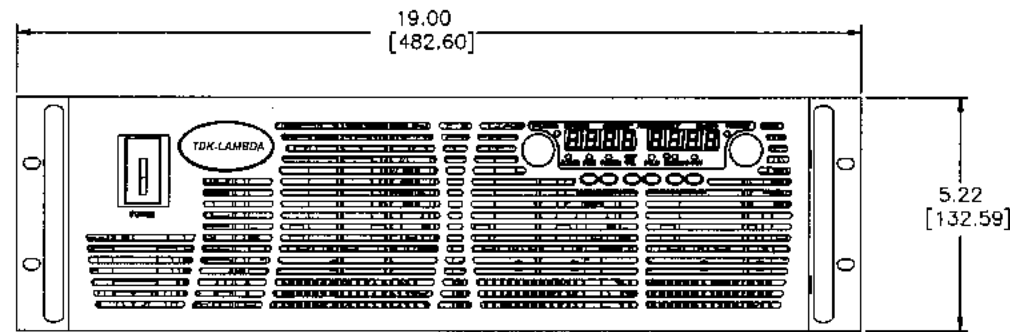

FUNCTIONAL GROUND  
M5x 0.8 X 29/32 LONG THREADED STUD.  
[23mm]

DIMENSIONS WITH BRACKET [ ]  
ARE METRIC EQUIVALENT  
IN MILLIMETERS.

SHEET 2 OF 6

MFG.		REL. TO MFG.	ENG. CTL.	TITLE	
ENG. DATE	SEE SHEET ONE	DATE	DATE	TDK-Lambda	
DWG. DATE	SEE SHEET ONE	DATE	DATE	DIM OUTLINE	
APP. DATE	SEE SHEET ONE	DATE	DATE	GEN 3U PLATFORM A STD	
DWG. REL. DATE	SEE SHEET ONE	DATE	DATE	DWG. NO.	02-530-000
APP. DATE	SEE SHEET ONE	DATE	DATE	REV	B