

Cordex HP Controller Software Manual

Technical Guide: 0350058-J0

Effective: 02/2020



Cordex HP Controller Software Manual

NOTE: Photographs contained in this manual are for illustrative purposes only. These photographs may not match your installation.

NOTE: Operator is cautioned to review the drawings and illustrations contained in this manual before proceeding. If there are questions regarding the safe operation of this powering system, contact Alpha Technologies or your nearest Alpha representative.

NOTE: Alpha shall not be held liable for any damage or injury involving its enclosures, power supplies, generators, batteries, or other hardware if used or operated in any manner or subject to any condition inconsistent with its intended purpose, or if installed or operated in an unapproved manner, or improperly maintained.

HELIOS POWER
SOLUTIONS
NEW ZEALAND
www.heliosps.co.nz

HELIOS POWER
SOLUTIONS
AUSTRALIA
www.heliosps.com.au

HELIOS POWER
SOLUTIONS
MIDDLE EAST & ASIA
www.heliosps.asia

Helios Power Solutions is Alpha Technologies partner and has been providing DC Power Solutions over the last 35 years.

No part of this documentation shall be reproduced, stored in a retrieval system, translated, transcribed, or transmitted in any form or by any means manual, electric, electronic, electromechanical, chemical, optical, or other-wise without prior explicit written permission from Alpha Technologies.

This document, the software it describes, and the information and know-how they contain constitute the proprietary, confidential and valuable trade secret information of Alpha Technologies, and may not be used for any unauthorized purpose, or disclosed to others without the prior written permission of Alpha Technologies.

The material contained in this document is for information only and is subject to change without notice. While reasonable efforts have been made in the preparation of this document to assure its accuracy, Alpha Technologies assumes no liability resulting from errors or omissions in this document, or from the use of the information contained herein. Alpha Technologies reserves the right to make changes in the product design without reservation and without notification to its users.

Contents

List of Figures.....	12
List of Tables.....	16
1. Safety.....	17
2. Software Release History.....	20
2.1. Application Release 6.20.....	20
2.2. Application Release 6.10.....	20
2.3. Application Release 6.00.....	21
2.4. Application Release 5.20.....	21
2.5. Application Release 5.10.....	22
2.6. Application Release 5.01.....	22
2.7. Application Release 5.00.....	22
2.8. OS Release 6.00.....	23
2.9. OS Release 5.20.....	23
2.10. OS Release 4.70.....	23
2.11. OS Release 2.20.....	23
2.12. Known Issues.....	24
3. Introduction.....	26
3.1. Using the CXC HP Software Manual.....	26
3.1.1. Purpose and Audience.....	26
3.1.2. Knowledge and Permissions.....	26
3.2. Product Overview.....	26
3.2.1. What Does the CXC HP Do?.....	27
3.2.2. Typical System Configuration.....	28
3.2.3. How to Get Help.....	28
4. Getting Started.....	31
4.1. Applying Power.....	31
4.2. Connecting the Controller.....	31
4.2.1. In-Shelf Controller.....	32
4.3. Navigating the CXC HP User Interface.....	33
4.3.1. Logging in to the Controller.....	33
4.3.2. Controller Menu Map.....	34
4.3.3. Overview of the LCD Interface.....	36

4.3.4. Overview of the Web Interface.....	46
4.3.5. Overview of the In-Shelf Display.....	57
4.4. Email Notification.....	60
4.5. Setting up SNMP Communication.....	62
4.6. Setting up Modbus Communication.....	64
5. DC Power Systems.....	66
5.1. Guidelines for Commissioning the DC System.....	66
5.1.1. The Battery Mode.....	67
5.2. DC System Functions.....	67
5.2.1. Modules, Inventory and System Functions.....	67
5.2.2. Mixed Rectifier System.....	68
5.2.3. Battery Charging.....	69
5.2.4. Battery Temperature Compensation.....	70
5.2.5. Battery Runtime and Health Estimation.....	71
5.2.6. Low Voltage Disconnect Operation.....	72
5.2.7. Battery Test.....	73
5.2.8. Power Save.....	75
5.3. Creating a DC System Manually.....	76
5.3.1. Quick Reference for Configuring a DC System.....	77
5.3.2. Creating a DC System.....	78
5.3.3. Configure the Basic DC System Settings.....	81
5.3.4. Configure Dynamic Thresholds for Output Voltage Alarms.....	81
5.3.5. Configure the Rectifiers.....	81
5.3.6. Configure the Shunts.....	83
5.3.7. Configure the Loads.....	83
5.3.8. Configure the Current Transducer.....	84
5.3.9. Configure the General Purpose Transducer.....	84
5.3.10. Configure the Disconnects.....	85
5.3.11. Configure the Battery Parameters.....	86
5.3.12. Configure the Battery Temperature Sensors.....	88
5.3.13. Configure the Charging System Function.....	89
5.3.14. Configure the Temperature Compensation System Function.....	90
5.3.15. Configure Battery Runtime and Health Estimation.....	91
5.3.16. Run a Manual Battery Test.....	91

5.3.17. Configure Power Save.....	92
5.4. Connecting to Other Systems.....	92
5.4.1. Representing a Converter System as a DC Load.....	92
5.4.2. Representing an Inverter System as a DC Load.....	93
6. Converter Systems.....	94
6.1. Introduction to Converter Systems.....	94
6.2. Creating a Converter System.....	95
6.2.1. Creating a System from a Configuration File.....	96
6.3. Configure the Converters.....	97
6.4. Configure the Shunts.....	97
6.5. Configure the Loads.....	98
6.6. Configure the Current Transducer.....	98
6.7. Configure the General Purpose Transducer.....	99
7. Inverter Systems (Single T2S).....	100
7.1. Introduction to Inverter Systems.....	100
7.1.1. Components of a Single T2S Inverter System.....	100
7.1.2. Quick Reference for Configuring an Inverter System.....	102
7.1.3. Phase and Group Data.....	102
7.1.4. Live Alerts.....	103
7.1.5. System Functions.....	103
7.2. Creating an Inverter System.....	104
7.2.1. Creating a System from a Configuration File.....	104
7.3. Assigning a T2S.....	105
7.4. Commissioning a Single T2S Inverter System.....	105
7.5. Configure the T2S.....	107
7.6. Configure the Inverters.....	108
7.7. Configure the Bypass Switch.....	109
7.8. Configure the Breaker or Fuse.....	111
8. Line Power Systems.....	113
8.1. Introduction to Line Power Systems.....	113
8.1.1. Components of a Line Power System.....	113
8.1.2. Quick Reference for Configuring a Line Power System.....	115
8.2. Creating a Line Power System.....	115
8.2.1. Creating a System from a Configuration File.....	116

8.3. Configure the Line Power Modules.....	116
8.3.1. Shared Alarm Configuration.....	117
8.4. Line Power Module Alarms.....	117
8.5. Configure the Line Power System Channels.....	118
8.6. Configure the Line Power System Loads.....	118
8.7. Line Power System Layout.....	119
8.7.1. Using the Layout Screen to View Module Status.....	119
8.7.2. Using the Layout Screen to View Load Status.....	120
8.7.3. Using the Layout Screen to Assign Channels to Loads.....	121
9. Auxiliary Systems.....	124
9.1. Introduction to Auxiliary Systems.....	124
9.2. Create an Auxiliary System.....	124
9.2.1. Creating a System from a Configuration File.....	124
9.3. Current Transducers.....	124
9.4. Configure the Current Transducer.....	124
9.5. Configure the General Purpose Transducer.....	125
10. Distribution Systems.....	126
10.1. Introduction to Distribution Systems.....	126
10.2. Creating a Distribution System.....	127
10.2.1. Creating a System from a Configuration File.....	128
10.3. Distribution Subsystems.....	128
10.4. Create a Smart Subsystem.....	128
10.5. Create a User Defined Subsystem.....	129
10.6. Configure the Panel Details.....	130
10.7. Configure the Breaker/Fuse Details.....	131
10.8. The Subsystem Layout.....	132
10.9. Map Shunts to ADIO Inputs.....	132
11. DC Source Systems.....	134
11.1. Creating a DC Source System.....	134
11.2. Create and Configure a DC Source.....	134
11.3. DC Generator.....	135
11.3.1. Create and Configure a DC Generator.....	135
11.4. DC Source System Effect on Other Systems.....	136
12. AC Source Systems.....	137

12.1. Creating an AC Source System.....	137
12.2. Create an AC Source.....	137
12.2.1. Map Rectifiers to an AC Source.....	138
12.3. AC Generator.....	139
12.3.1. Create an AC Generator.....	139
12.3.2. Configure Generator Control.....	140
13. FXM-HP Systems.....	141
14. Controller Redundancy.....	142
15. Power Flow.....	143
15.1. Introduction to Power Flow.....	143
15.2. Accessing the Power Flow.....	143
15.2.1. Getting Help.....	144
15.2.2. Using Power Flow Configuration Suggestions.....	144
15.2.3. Configuring the Default Power Flow.....	145
15.3. Interacting with the Power Flow.....	145
15.4. Controller Power Flow.....	146
15.5. Power Flow for Systems Managed by Different Controllers.....	147
16. Maintaining the System.....	148
16.1. Rectifier Maintenance.....	148
16.1.1. Rectifier Alarms.....	148
16.1.2. Insert Unassigned Modules.....	148
16.2. Inverter and T2S Maintenance.....	148
16.2.1. Maintenance Bypass.....	149
16.2.2. Taking Power from DC Source.....	149
16.2.3. Replace Fan.....	150
16.2.4. Identifying an Inverter.....	151
16.2.5. Alarms and Alerts.....	151
16.2.6. Replacing a T2S.....	151
16.2.7. Shelf Layout.....	152
16.3. Line Power System Maintenance.....	152
16.3.1. Powering On and Off Line Power Loads.....	152
16.3.2. Replacing Line Power Modules.....	152
16.4. Battery Maintenance.....	153
16.4.1. Battery Alarms.....	153

16.4.2. Charging Batteries.....	153
16.4.3. Maintaining Batteries.....	155
16.4.4. Battery Temperature Compensation.....	159
16.5. Low Voltage Disconnect (LVD) Maintenance.....	159
17. Maintaining the Controller.....	161
17.1. Ethernet Communications.....	161
17.1.1. Connecting via the Web.....	162
17.2. Working with Alarms, Alerts and Hints.....	162
17.2.1. Active Alarms.....	162
17.2.2. Alerts.....	163
17.2.3. Hints.....	163
17.2.4. Alarm Cut-off.....	163
17.2.5. Alarm Activation Delay at Startup.....	164
17.2.6. Alarm Summary Relays.....	164
17.2.7. Creating User Alarms.....	164
17.3. Controller Maintenance.....	165
17.3.1. Restarting the Controller.....	166
17.3.2. Restarting via the LCD.....	166
17.3.3. Powering Down the Controller.....	167
17.3.4. Changing the Time and Date.....	167
17.3.5. Changing the Default Login Language.....	168
17.3.6. Changing User Interface Strings.....	169
17.3.7. Changing the Web Session Language.....	170
17.3.8. Changing the System Status Bar.....	171
17.3.9. Changing the Dashboard Values.....	171
17.3.10. Data Sharing.....	172
17.4. Working with Logs.....	173
17.4.1. Event and Alert Logs.....	174
17.4.2. Battery Log.....	174
17.4.3. Power Outage Log.....	175
17.4.4. Datalogs.....	176
17.4.5. Performance Logs.....	179
17.5. File Maintenance.....	180
17.5.1. File Preferences.....	181

17.5.2. File Maintenance via the LCD.....	181
17.5.3. Upgrading the Controller Software.....	183
17.5.4. Exporting Configuration.....	184
17.5.5. Importing Configuration.....	185
17.5.6. Configuration Restore Points.....	187
17.5.7. Exporting Diagnostic Information.....	189
17.5.8. Licensing.....	189
17.5.9. Uploading the Software Manual.....	191
17.5.10. Exporting Inventory.....	192
17.6. User Account Maintenance.....	193
17.6.1. Setting Up Users and Permissions.....	193
17.6.2. Editing User Permissions.....	193
17.6.3. Enabling New Users.....	193
17.6.4. Disabling Users.....	195
17.6.5. Changing the Default Password - LCD.....	196
17.6.6. Changing the Default Password - Web.....	196
17.6.7. Remote Configuration Lockout.....	197
17.7. Remote Authentication.....	198
17.7.1. RADIUS Authentication.....	199
17.7.2. TACACS+ Authentication.....	200
17.8. Flash Maintenance.....	202
17.8.1. Memory Status.....	202
17.8.2. Using Flash Refresh.....	203
17.9. Secure Web Server.....	203
17.9.1. HTTPS And Certificate Overview.....	203
17.9.2. Configuring HTTPS.....	204
17.10. VLAN Support.....	206
17.11. Testing Relays.....	208
18. Maintaining Modules.....	209
18.1. ADIO Maintenance.....	209
18.1.1. Configuring an ADIO.....	209
18.1.2. Replacing an ADIO.....	210
18.1.3. Calibrating Analog Inputs.....	211
18.1.4. Calibrating Shunts, Current Transducers and Temperature Probes.....	219

18.1.5. Testing Relays.....	222
18.1.6. Testing Comms Lost Action.....	223
18.1.7. Enabling Temperature Sensor Failure Alarms.....	223
18.1.8. Ground Fault Detection.....	224
18.2. Module Firmware Upgrades.....	224
18.2.1. Module Firmware Upgrade.....	224
18.2.2. Uploading a Firmware File.....	225
18.2.3. Selecting the File to Upgrade.....	226
18.2.4. Upgrading the Module.....	227
19. Using Custom Data, Timers, Counters, Scheduler and Custom Actions.....	229
19.1. Using Custom Data.....	229
19.1.1. Configuring Custom Data.....	229
19.1.2. Creating Custom Data.....	232
19.1.3. Creating Custom Data - Basic Work Flow.....	232
19.1.4. Creating Custom Data - Detailed Work Flow.....	232
19.1.5. Custom Data Examples.....	234
19.1.6. Custom Data - Summing Load Shunts.....	234
19.1.7. Custom Data - AC Cooling too Low User Alarm.....	235
19.2. Using Timers.....	237
19.2.1. Configuring the Delay Timer.....	237
19.2.2. Configuring the Interval Timer.....	238
19.3. Using Counters.....	239
19.3.1. Configuring the Up Counter.....	239
19.3.2. Configuring the Down Counter.....	240
19.4. Using Scheduler.....	241
19.4.1. Configuring a Recurring Action.....	241
19.5. Configuring a One-Time Action.....	242
19.6. Configuring Scheduled Actions.....	243
19.7. Using Scheduled Time Spans.....	244
19.8. Using Custom Actions.....	245
19.8.1. Configuring a Change Relay Action.....	245
19.8.2. Configuring a Change Field To Constant Action.....	246
19.8.3. Configuring a Change Field To Variable Action.....	247
20. Troubleshooting.....	249

20.1. Troubleshooting Your Controller.....	249
20.1.1. No Communication.....	249
20.1.2. Unable to Communicate via Ethernet.....	249
20.1.3. Home Button or LCD Screen Not Responding.....	249
20.1.4. Controller Fail.....	250
20.2. Troubleshooting a Rectifier System.....	251
20.2.1. Relays Not Triggered During Alarm Conditions.....	251
20.2.2. Rectifier Alarms and Alerts.....	251
20.2.3. Rectifier Not Acquired.....	251
20.2.4. Rectifier Communication Lost.....	252
20.2.5. Replacing a Defective Rectifier.....	252
20.2.6. Using Extended Ranges.....	252
20.2.7. Rectifier Configuration Error.....	253
20.2.8. Rediscovering CAN Devices.....	254
20.2.9. Replacing a Defective ADIO.....	254
20.2.10. Troubleshooting a Battery Test.....	254
20.2.11. Troubleshooting Power Save.....	255
20.3. Troubleshooting an Inverter System.....	256
20.3.1. Wrong Inverter AC Input Group.....	256
20.3.2. Wrong Inverter DC Input Group.....	256
20.3.3. T2S Expert Operations.....	257
20.3.4. Troubleshooting and Clearing the System Error Alarm.....	257
20.3.5. Phase Saturation Alarm.....	258
20.4. Troubleshooting a Line Power System.....	258
20.4.1. Resolving Line Power System Alarms.....	258
20.4.2. Fan Tray Alarms.....	259
20.4.3. Line Power System Overload.....	259
20.4.4. Line Power System Transient Events.....	259
21. CXC HP Reference Guide.....	260
21.1. Modules.....	260
21.2. Communication Ports.....	261
21.2.1. Ethernet Ports.....	262
21.2.2. USB Ports.....	262
21.2.3. CAN Ports.....	262

21.3. Default System Values and Ranges.....	264
21.3.1. 12V System Default Values and Ranges.....	264
21.3.2. 24V System Default Values and Ranges.....	265
21.3.3. 48V System Default Values and Ranges.....	266
21.3.4. 125V System Default Values and Ranges.....	266
21.3.5. 220V System Default Values and Ranges.....	267
21.3.6. AC Voltage Alarm Ranges.....	268
22. Certification.....	269
23. Glossary.....	270
24. Index.....	

List of Figures

Figure 1: CXC HP Controller (2RU model).....	27
Figure 2: Typical DC System Configuration.....	28
Figure 3: Accessing Help on the LCD Interface.....	29
Figure 4: Accessing Help on the Web Interface.....	29
Figure 5: Accounts and Shortcuts.....	30
Figure 6: Menu Structure.....	35
Figure 7: CXC HP Controller Dashboard.....	36
Figure 8: Maintenance Page.....	37
Figure 9: System Maintenance Page.....	37
Figure 10: LCD Menus.....	38
Figure 11: Controller Status.....	39
Figure 12: Time and Date.....	39
Figure 13: Timezone.....	40
Figure 14: Network Time Server.....	40
Figure 15: Synchronize Time.....	41
Figure 16: Shortcuts.....	41
Figure 17: Ethernet.....	42
Figure 18: Inventory.....	42
Figure 19: Dashboard with Multi-system Panels.....	43
Figure 20: Dashboard Using Wide Data Panel View.....	43
Figure 21: Language.....	44
Figure 22: Browse USB.....	44
Figure 23: Export Diagnostic Information.....	45
Figure 24: Backup.....	45
Figure 25: Dashboard Overview on Web Interface.....	47
Figure 26: Main Dashboard Tables.....	48
Figure 27: Table Icons.....	48
Figure 28: Global Search Example.....	49
Figure 29: Web Interface Table Features.....	50
Figure 30: Controller Menu.....	50
Figure 31: System Wizards.....	51
Figure 32: Controller with No System Configured.....	52

Figure 33: Systems Data Tiles.....	52
Figure 34: System Menu.....	52
Figure 35: Modules Menu.....	54
Figure 36: Alarms Menu.....	54
Figure 37: Logs Menu.....	55
Figure 38: Shelf Layout Menu.....	56
Figure 39: In-Shelf Controller Dashboard Screens.....	58
Figure 40: In-Shelf Controller Menu.....	58
Figure 41: In-Shelf Controller Buttons: Vertical Mount.....	59
Figure 42: In-Shelf Controller Buttons: Horizontal Mount.....	60
Figure 43: Default Ports: SMTP Client and Server.....	60
Figure 44: Default Ports: SNMP Manager and Agent.....	63
Figure 45: SNMP Destination Page:.....	63
Figure 46: Destination 1 More Information Page:.....	64
Figure 47: Default Ports: Modbus Client (Master) and Server (Slave).....	64
Figure 48: Enabling Modbus on the Controller.....	65
Figure 49: Battery Mode.....	67
Figure 50: Three-Stage Charging Cycle.....	69
Figure 51: Temperature Compensation Voltage Graph.....	71
Figure 52: Inhibit Disconnect.....	72
Figure 53: Example of a DC System.....	77
Figure 54: Quick Reference for Configuring a DC System.....	78
Figure 55: Configure DC System Results Page.....	80
Figure 56: Example Converter System.....	94
Figure 57: Quick Reference for Configuring a Converter System.....	95
Figure 58: Create Converter System Wizard.....	96
Figure 59: Single T2S Inverter System Components.....	101
Figure 60: Quick Reference for Configuring an Inverter System.....	102
Figure 61: Create Inverter System Wizard.....	104
Figure 62: Commission Inverter System Wizard.....	106
Figure 63: Example LPS36 System.....	114
Figure 64: Example eLimiter+ System.....	114
Figure 65: Quick Reference for Configuring a Line Power System.....	115
Figure 66: Create Line System Wizard.....	116

Figure 67: Example of a DC System Distribution System.....	127
Figure 68: Example of BDFB Distribution Subsystem.....	129
Figure 69: Example of a User Defined Subsystem.....	130
Figure 70: Distribution Subsystem Layout.....	132
Figure 71: Power Flow for a DC System.....	143
Figure 72: Navigating to Power Flow.....	144
Figure 73: Power Flow Configuration Suggestions.....	144
Figure 74: Interacting with the Power Flow.....	145
Figure 75: Power Flow Controls.....	146
Figure 76: Controller Power Flow.....	146
Figure 77: Using Data Sharing to Create Power Flow Across Different Controllers.....	147
Figure 78: Add/Remove Inverters.....	149
Figure 79: Battery Charging Tables.....	154
Figure 80: Battery Maintenance System Functions.....	155
Figure 81: Battery Runtime and Health Menu.....	155
Figure 82: Events and Alerts Log.....	174
Figure 83: Battery Log on the LCD.....	175
Figure 84: Battery Log on the Web.....	175
Figure 85: Battery Log in Excel.....	175
Figure 86: Datalogs Table.....	176
Figure 87: Datalog Window: Status, Signals, Configuration and Preview Chart.....	176
Figure 88: CPU Memory in Use Performance Log.....	180
Figure 89: The Licensing Page.....	191
Figure 90: RADIUS Configuration Table.....	200
Figure 91: TACACS+ Configuration Table.....	202
Figure 92: Web Server Port Communications.....	204
Figure 93: Example Certificate.....	205
Figure 94: Valid Certificate.....	205
Figure 95: Incomplete Certificate.....	206
Figure 96: VLAN Support.....	207
Figure 97: VLAN Support Table.....	207
Figure 98: Module Upgrade Page - web.....	224
Figure 99: Module Upgrade - LCD.....	225
Figure 100: Firmware Files Table.....	225

Figure 101: Upload File Dialog.....	226
Figure 102: Ready to Start Upgrade.....	227
Figure 103: Upgrade in Progress.....	227
Figure 104: Upgrade Succeeded.....	228
Figure 105: Custom Data Load Current Shunts.....	235
Figure 106: Scheduler Wizard.....	244
Figure 107: CAN Differential Signaling.....	263
Figure 108: CAN Network Topology.....	263
Figure 109: Alpha CAN Connector.....	264

List of Tables

Table 1: In-Shelf Controller Full Menu.....	58
Table 2: Email Notification Features.....	60
Table 3: Email Configuration.....	62
Table 4: ADIO Input Calibration Modes.....	212
Table 5: Troubleshooting Power Save.....	255
Table 6: Support for CAN Modules.....	260
Table 7: 12V System Default Values.....	264
Table 8: 24V System Default Values.....	265
Table 9: 48V System Default Values.....	266
Table 10: 125V System Default Values.....	267
Table 11: 220V System Default Values.....	267
Table 12: AC Voltage Alarm Ranges.....	268

1. Safety

SAVE THESE INSTRUCTIONS: This manual contains important safety instructions that must be followed during the installation, servicing, and maintenance of the product. Keep it in a safe place. Review the drawings and illustrations contained in this manual before proceeding. If there are any questions regarding the safe installation or operation of this product, contact Alpha Technologies or the nearest Alpha representative.

Safety Wording/Symbols

To reduce the risk of injury or death, and to ensure the continued safe operation of this product, the following symbols have been placed throughout this manual. Where these symbols appear, use extra care and attention.

 **Attention:** *The use of attention indicates specific regulatory/code requirements that may affect the placement of equipment and /or installation procedures.*

 **Note:** *Notes provide additional information to help complete a specific task or procedure.*

 **CAUTION:** *Cautions indicate safety information intended to PREVENT DAMAGE to material or equipment.*

 **Warning:** *Warnings present safety information to PREVENT INJURY OR DEATH to personnel.*

 **Note:** *HOT! The use of Hot presents safety information to PREVENT BURNS to the technician or user.*

General Warning and Cautions

 **Warning:**

You must read and understand the following warnings before installing the system and its components. Failure to do so could result in personal injury or death.

- Read and follow all instructions included in this manual.
- Only trained personnel are qualified to install or replace this equipment and its components.
- Use proper lifting techniques whenever handling equipment, parts, or batteries.

Electrical Safety

 **Warning:**

Hazardous voltages are present at the input of power systems. The DC output from some rectifiers and batteries can have high voltage and high short-circuit current capacity that may cause severe burns and electrical arcing.

Before working with any live battery or power system, follow these precautions:

- Remove all metallic jewelry, such as watches, rings, metal rimmed glasses, or necklaces.

- Wear safety glasses with side shields at all times during the installation.
- Use OSHA approved insulated hand tools. Do not rest tools on top of batteries.

 **Warning:**

Lethal voltages are present within the power system. Always assume that an electrical connection or conductor is energized. Check the circuit with a voltmeter with respect to the grounded portion of the enclosure (both AC and DC) before performing any installation or removal procedure.

- Do not work alone under hazardous conditions.
- A licensed electrician is required to install permanently wired equipment. Input voltages can range up to 480Vac. Ensure that the utility power is disconnected and locked out before performing any installation or removal procedure.
- Ensure that no liquids or wet clothes come into contact with internal components.
- Hazardous electrically live parts inside this unit are energized from the batteries even when the AC input power is disconnected.
- The enclosure which contains the DC or AC power system along with customer installed radios must remain locked at all times, except when authorized service personnel are present.
- Always assume electrical connections or conductors are live. Turn off all circuit breakers and double-check with a voltmeter before performing installation or maintenance.
- Place a warning label on the utility panel to warn emergency personnel that a reserve battery source is present which will power the loads in a power outage condition or if the AC disconnect breaker is turned off.
- At high ambient temperature conditions, the internal temperature can be hot so use caution when touching the equipment.

Battery Safety

- Never transport an enclosure with batteries installed. Batteries must ONLY be installed after the enclosure has been securely set in place at its permanent installation location. Transporting the unit with batteries installed may cause a short circuit, fire, explosion, and/or damage to the battery pack, enclosure and installed equipment.
- Servicing and connection of batteries must be performed by, or under the direct supervision of, personnel knowledgeable of batteries and the required safety precautions.
- Batteries contain or emit chemicals known to cause cancer and birth defects or other reproductive harm. Battery post terminals and related accessories contain lead and lead compounds. Wash your hands after handling batteries.

 **Warning:**

Follow battery manufacturer's safety recommendations when working around battery systems. Do not smoke or introduce an open flame when batteries (especially vented batteries) are charging. When charging, batteries vent hydrogen gas, which can explode.

- Batteries are hazardous to the environment and should be disposed at a recycling facility. Consult the battery manufacturer for recommended local authorized recyclers.

2. Software Release History

The release history for recent versions are found below. For a full release history visit the Alpha website at **Support - Software/Firmware Downloads**.

2.1. Application Release 6.20

Released in Feb 2020.

Contains the following significant changes:

- Added support for ending a battery test based on state of charge (SOC).
- Added support for upgrading the OS via a web browser.
- Added support for setting some controller configuration from SNMP.
- Added Configuration Hints to help identify system states (i.e. Temperature Compensation) and potential configuration issues (i.e. missing or incorrectly configured settings).
- Added Power Flow for Line Power Systems. Also added the ability to show power flow between a DC system and AMPS-HP2 when those systems are on different controllers.
- Added Configuration Restore Points to better manage storing and restoring configuration files.
- Added basic support for AC and DC generator control.
- Added AC current to performance log for AMPS HP2 systems.
- Added support for starting timers manually.
- Added support for the Alpha XMBS Smart Bypass.
- Added support for Controller Redundancy.

2.2. Application Release 6.10

Released in October 2019.

Contains the following significant changes:

- Added a feature to automatically back up configuration to USB drive on a schedule.
- Added a feature to manually set the bay/shelf/slot ID of CAN devices that do not automatically provide this information.
- Improved the way time data is displayed and entered as configuration.
- Added basic support for a generic AC Input source to allow for mapping rectifiers to different AC inputs.
- Added a disconnect that can be used for load shedding.
- Added a feature to allow an ADIO relay to be used to indicate when the ADIO loses CAN communication. This functionality requires a firmware upgrade on any supported ADIO device.
- Added shunt and transducer to allowable FXM-HP inventory.
- Added power Outage Logs Section under Working with Logs.

2.3. Application Release 6.00

Released in July 2019.

Contains the following significant changes:

- Support for distribution systems in Power Flow.
- Added a Test Alarm button for each alarm.
- Improved filtering and searching on the WEB UI.
- Improved Add Load/Shunt Pairs wizard and Map Shunts to ADIO Inputs wizard to allow naming and manual mapping.
- Support for French language.
- Improved battery configuration based on battery model number.
- Added multiple scrollable screens on the LCD dashboard.
- Added an SNMP table to view active module alerts.
- Support for FXM-HP.
- Added a system shortcut page to LCD UI. Accessed with button press on the LCD dashboard.
- Support for the current transducer IPM (interface and power module).
- Added ability to reset the IP address from the OLED display on in-shelf controllers.
- Added ability to set up a datalog to capture a sample on a change in value.
- Added a new user role for Restricted Operator. Restricted Operator does not have permission to add or remove items from systems.
- Added more rectifier information to the rectifier details screen.
- Added option to include T2S configuration and event log to diagnostic export.

2.4. Application Release 5.20

Released in March 2019.

Contains the following significant changes:

- Added support for TACACS+ remote authentication.
- Added support for multiple battery strings.
- Added a generic external DC source to properly account for other sources of current on the DC bus, like photo-voltaic panels.
- Added support for Power Flow display of AMPS HP2 systems.
- Added support for AMPS HP2 systems data over Modbus TCP/IP.
- Improved display of data for loads, shunts, rectifiers, converters in the LCD Inventory Summary page.
- Improved performance of SNMP.
- Added a feature called Data Sharing to share a limited amount of data between CXC HP controllers.

2.5. Application Release 5.10

Released in November 2018.

Contains the following significant changes:

- Added a feature to download inventory to a USB drive or to the PC. This includes most configuration and status values that are displayed on the user interface.
- Add a feature to disable write access through the web browser unless overridden by a local user through the LCD interface.
- Added a new battery conditioning mode for Boost.
- Added user configurable termination conditions to Equalize and Elevated Absorption modes.
- Added a new type of inventory called General Purpose Transducer, similar to a current transducer. This inventory can be created in a DC system, Converter system and Auxiliary system.
- Modified the limitation of 10 distribution subsystems (BDFB, E2, user defined) to allow more E2 systems. Up to 40 E2 subsystems can be supported if there are no other BDFB or user defined subsystems created.
- Fixed an issue with the SNMP trap destination port always being set to 162, even if configured as something else.

2.6. Application Release 5.01

Released in August 2018.

Contains the following significant changes:

- Full Modbus TCP support for the DC System, controller, custom data, timers, counters, user alarms.
- Added a wizard to help configure multiple shunts and associated loads in the DC system.
- Fixed an issue with setting the 'True If' value for custom data state variable when the variable was a boolean.
- Added a user configurable startup delay for alarm processing to avoid nuisance alarms and traps.
- Fixed an issue with the bus voltage fault status of a disconnect when the Invalid System Voltage alarm was disabled.
- Limit response to SNMP GetRequests to five per second to avoid excessive CPU usage.
- Added additional statistics for total output current performance log of the DC system to keep track of top three hourly average maximums.
- Fixed a problem with display of temperature in Fahrenheit on the Datalogs.

2.7. Application Release 5.00

Released in May 2018.

To upgrade to this version from v4.20 and previous, it is necessary to first install v4.90.

Contains the following significant changes:

- Power Flow view for the DC System to visually show system status and important information.
- Support for HTTPS secure web server protocol.
- Support for RADIUS remote authentication protocol.
- Allow user customizable alarm names and the ability to hide default name/id strings.
- Added ability to set the thresholds used to decide when a battery is charging or discharging for better support of systems with light loads and large batteries.
- Added drop down navigation links to the menu bar.

2.8. OS Release 6.00

Released in July 2019.

Contains the following significant changes:

- Improved longevity and operation of non-volatile memory

2.9. OS Release 5.20

Released in March 2019.

Contains the following significant changes:

- Changed RAM timings for better compatibility with different RAM chips

2.10. OS Release 4.70

Released in February 2019.

Contains the following significant changes:

- Improve FLASH programming reliability.
- Add feature to allow application to start a FLASH refresh for FLASH used by OS
- Support for VLAN
- Fix for clock overflow

2.11. OS Release 2.20

Release in August 2015.

Contains the following significant changes:

- Support in-shelf controller product

2.12. Known Issues

- In version 6.00, on systems with high voltage rectifiers (except 125V/4.4kW), a Rectifier Configuration Error alarm will occur. This alarm cannot be cleared. Upgrade to 6.10, or downgrade to 5.21 or earlier to solve this problem.
- In version 4.10, the SNMP trap varbinds “controllerInfoName” and “alarmSeverity” swapped position. This was remedied in v4.20 so that the varbinds match the position as specified in the MIB as they did in versions previous to 4.10.
- When using a MIB browser to read controller data that represents a state, the numeric value of the state is moved to the dataNumberValue column (from the dataStringValue column) and it’s string value is now shown in the dataStringValue column.
- Downgrading
 - Downgrading the CXC HP software should be a rare occurrence. When software is downgraded, any configuration settings for features that don't exist in earlier versions are discarded. Because some configurations are discarded, the controller may require manual intervention to ensure every setting is correct. Restoring a backup file that was made with the earlier version of software is recommended instead.
 - In versions 2.X and 3.X of the software, we found two issues. The first is that when the software encountered an inverter or distribution system that it didn't understand, the software discarded more data than expected. The second is that when a custom data variable had data discarded, the controller would crash and not recover.
 - If a downgrade from v4.00 software becomes a necessity, you can avoid these problems by deleting all inverter systems, distribution systems and all custom data before performing the downgrade.
- Importing of configuration files from later version to earlier versions may fail - especially if the controller is running a version previous to v4.00. If the import fails it may be because it contains new systems or custom data that uses variable values that do not exist. Try importing using a configuration file that doesn't contain inverter systems, distribution systems or custom data.
- File upload works in Microsoft Edge, IE10+, Chrome 5+, Firefox 3.4+ and Safari 4+. File upload does not work in Internet Explorer 9 (IE9). If using IE9, you can not upload the CXC HP Application upgrade or the ACAN files for CAN Module upgrades.
- For **Controller > Advanced Functions > Custom Data > Counters** and **Controller > Advanced Functions > Custom Data > Timers**, the counter and timer values do not persist, they go back to their default values on a restart.
- The LCD does not currently support accented characters for passwords or aliases.
- Performance logs and Datalogs cannot run if there is a **Clock Error Alarm**. Once you correct the clock error alarm, it is a good idea to restart the controller to ensure that all of the logging starts up properly.
- The Datalog has a **Capture When True** configuration field that is used to control when data is captured. If you delete the value that **Capture When True** is pointing to (e.g. a **Custom Data** value), the **Capture When True** field should change to Unknown but does not use. The user has to manually set this field back to Unknown or the Datalog will continue to use the old value.

- Custom data will sometimes give an error message **Variable Not Mapped** when the real error message should be **Variable Has a Value of Unknown**.
- Digital input state for digital inputs on BDFB devices was corrected. If a v3.22 or earlier configuration file is uploaded, the following configuration fields may not be imported as expected. Check the following for correctness: BDFB digital input **Active When** field; the custom data variable using a BDFB digital input; and the user alarm using a BDFB digital input.
- If the Disconnect Active alarm is active, and the relay is unmapped from the disconnect, the alarm will not clear. To clear the alarm, remap a relay and clear the alarm condition, or remove the disconnect from the system.
- The in-shelf controller display does not display auxiliary systems. When one of these systems is selected for display, the display shows the text **No System**.
- Due to performance constraints on the CXC HP, a total of 10 Smart BDFB or User-Defined distribution subsystems, OR 80 Smart E2 distribution subsystems, can be created. This difference in limit is due to Smart BDFB and User-Defined subsystems requiring more processing power than Smart E2 subsystems due to the amount of data provided. A combination of the two limits can also be created (for example, 5 Smart BDFB subsystems and 40 Smart E2 subsystems).
- Events that occur very early during the controller startup process may be logged with a time-stamp that is in UTC time rather than local time.
- A lightly loaded or phase unbalanced inverter system displays inaccurate readings for some values. When a system is loaded sufficiently, the readings will be correct.
- In v6.00+ the Battery Temperature Anomaly alarm is disabled by default on the Battery. If it is required, set up one or more battery strings to use this alarm.
- When using the UPS-MIB with the FXM-HP, the controller will send two alarm traps. One is from the UPS-MIB, the other is from the ALPHA-RESOURCE-MIB .

3. Introduction

The purpose of this manual is to provide simple and complete information on how to use Alpha Technologies Cordex™ High Performance System Controller (CXC HP) and software / Smart BDFB Second Generation VI Meter (VIM). It contains an overview of the software features, on-site setup, and operation of the CXC HP / VIM, as well as information on creating, configuring and maintaining your system using the CXC HP / VIM.

3.1. Using the CXC HP Software Manual

3.1.1. Purpose and Audience

The audience of this manual are technicians and or facility operators tasked with installing, programming and commissioning, maintaining or troubleshooting the power system. When using the controller there are a variety of ways to perform most tasks. This guide covers using the touchscreen display, as well as the web interface.

3.1.2. Knowledge and Permissions

We assume you have a good working knowledge of, and access to, the following:

- Ethernet cables and TCP/IP settings needed to connect your computer to the CXC HP
- Current version of Microsoft Edge, Chrome 5+, Firefox,3.5+ Internet Explorer (9+), Safari 4+
- Power system that the CXC HP is controlling
- CXC HP login passwords and the appropriate level of permissions

3.2. Product Overview

This section provides an introduction to the controller, the controller software, as well as a brief overview of what the CXC HP does, how it works, and an image of a typical network configuration. The CXC HP (2RU model) has the following features:

- Front touchscreen: full color liquid crystal display (LCD) display with touchscreen, to access controls and menu items by using fingertip touch or a stylus.
- Home button: provides the ability to go directly back to the home screen from any menu.
- Front panel reset: for emergency use only to restart the CXC HP if the unit touch screen or home button are not responding.
- Front panel LEDs: for alarms, progress and status indication.
- Audio speaker: built-in audio speaker tones during active alarms and can be disabled if required.
- Ethernet: dual ports 10/100Base-T Ethernet connection on both the front and rear of the controller for remote or local communication.
- USB: dual ports on both the front and rear of the controller for upgrades or file management via a standard USB flash drive.

- CAN: dual independent CAN bus ports for communication with the Alpha Cordex™ and AMPS family of products.
- Real-time clock with field replaceable lithium battery: allows timestamps on alarms and events.
- System fail alarm/relay: activates when there is a major internal failure. During such a condition the unit attempts to reset.

Figure 1. CXC HP Controller (2RU model)

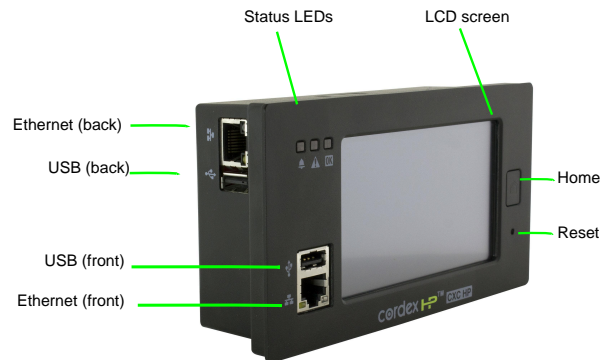

3.2.1. What Does the CXC HP Do?

The Cordex™ Controller HP (CXC HP) family provide centralized setup, control and monitoring of power systems. This can range from simple monitoring and threshold alarms for temperature, voltage and current, to advanced battery charging and diagnostic features.

The CXC HP provides Ethernet ports allowing for network, LCD and local laptop access to the controller including both web and SNMP interfaces.

The CXC HP supports CAN ports to allow up to 254 power and/or ADIO modules to be controlled and monitored. The CXC HP uses external analog and digital input and output (ADIO) peripherals to monitor electrical signals (temperature, voltage, temperature) and generate electrical signals through relays.

The most commonly used ADIO peripheral is the L-ADIO for low voltage systems which includes:

- 8 digital inputs
- 4 voltage sensors
- 4 temperature sensors
- 4 current sensors
- 12 Form C relay outputs

See the **Reference** section for a full list of power and ADIO modules that are supported by the CXC HP.

3.2.2. Typical System Configuration

The CXC HP is a scalable software platform that allows multiple systems to be created and managed by one controller. The user interface is organized around system inventory so you only see the systems that you have created and you can manage them independently. Both the web and the LCD provide a summary of all systems monitored by the controller as well as controller and alarm information.

The figure below shows a specific DC power system with the following elements:

- CXC HP controller and ADIO with CAN bus connections
- One or more rectifiers
- A battery string
- A shunt to measure battery current
- A battery low voltage disconnect (LVD) in series with the battery string

Figure 2. Typical DC System Configuration

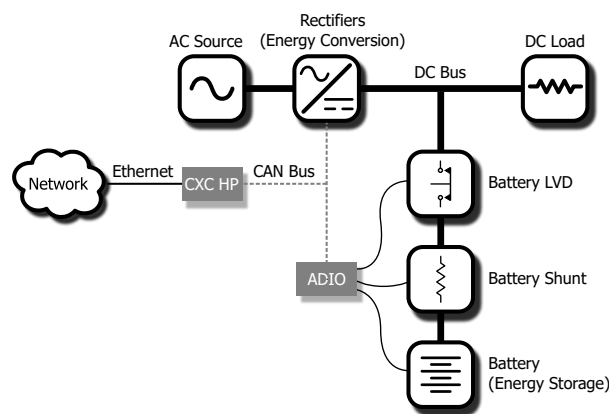

3.2.3. How to Get Help

The controller has **Help** on the web and the LCD screens, but not on the in-shelf display (CXC HP in-shelf controllers have a small organic LED (OLED) display). The **Help** menus provide a description of the product feature, its function and the typical default values. Each of the LCD menus has a descriptive Help statement. For example:

From the LCD dashboard click **Menu > Alarms and Events > Alarm Cut-Off and Global Alarm Settings > Alarm Cut-Off Period** and the screen provides information about the default cut off time.

Or the Help icon displays on a screen such as, **Menu > Controller > Configure Controller > Controller Description > Description > Name**.

Figure 3. Accessing Help on the LCD Interface

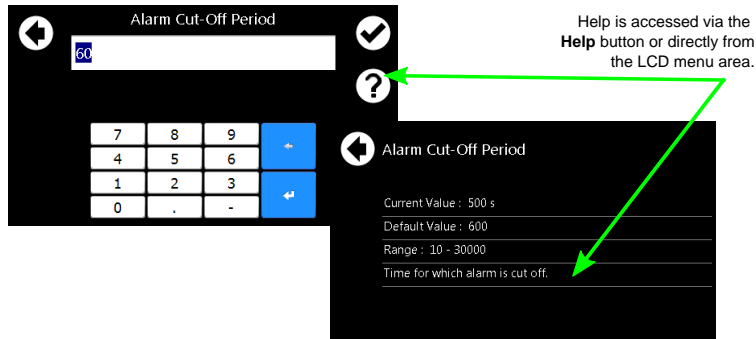

To get help via the web dashboard:

Click in any of the items on the dashboard area and the **Help** field displays. The help menus provide a description of the item, and in most cases a default value for the field.

Figure 4. Accessing Help on the Web Interface

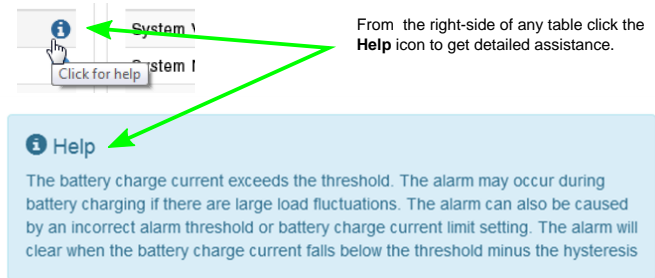

The software manual can be uploaded to the controller for quick access. Follow the steps in the **Uploading the Software Manual** section.

Once uploaded, access the manual via the web interface by clicking **Accounts and Shortcuts** on the top bar as shown in the Figure below.

Figure 5. Accounts and Shortcuts

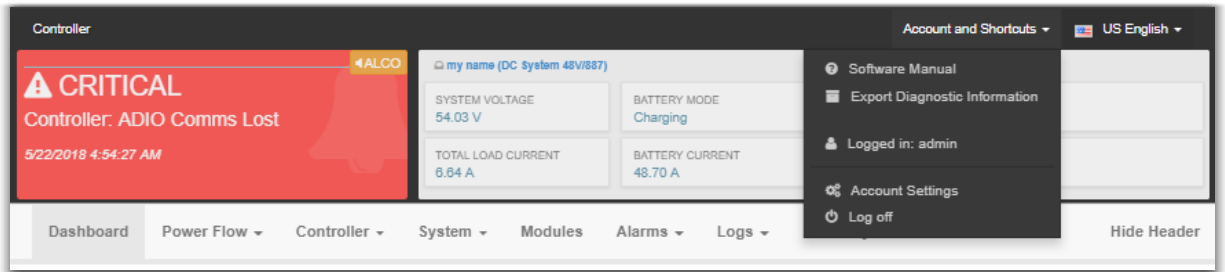

4. Getting Started

This section explains how to navigate the menus and do basic connection, monitoring and control functions using the LCD screen, the in-shelf display, and the web user interface of the CXC HP controller.

4.1. Applying Power

The CXC HP and most ADIO modules are designed to run on battery or DC bus power for 12, 24 and 48 volt systems. A Redundant Input Power Module is available to simplify the connection of power from above and below a battery LVD to both the CXC HP and ADIO modules.

1. Apply power to the controller (e.g. close battery breaker or rectifier input and output breakers).
2. The LEDs start cycling, and then after a few seconds the Cordex HP™ logo displays.
3. Wait for approximately about 30 seconds. The LEDs will turn off and the controller software will load.
4. Once the software is loaded, the green LED turns on (it may turn to yellow or red depending on the controller alarm state).

The front panel display shows the dashboard.

4.2. Connecting the Controller

There are three options for connecting to the controller web server from a web browser running on your computer:

- Through a local area network (LAN)
- Direct connection with IP auto-configuration
- Direct connection with static IP address

 **Note:** If the **Require Login for Sensitive Information** setting is enabled, a login will be required to view the IP settings on the LCD.

Factory Default Passwords

Obtain the user account information and passwords from the system administrator. The default values are:

- Default User Name: `admin`
- Default Password: `admin`

 **Note:** When using the in-shelf display, you can view, but not edit the IP settings.

Connection through a LAN

1. Use the LCD to verify that the Ethernet port is configured to acquire an IP address automatically. IP Address mode can be found by going to: **Shortcuts > Ethernet > Ethernet/Rear > Address Mode**.
2. Plug an Ethernet cable in to the rear Ethernet port and to your LAN. The computer that you want to connect the controller to must also be on this same LAN.
3. Use the LCD to determine the IP address automatically assigned to the controller. You can use either the IPv4 or IPv6 addresses. IP address information can be found at **Shortcuts > Ethernet > Ethernet/Rear**.
4. Enter this IP address into the address bar of your web browser and press enter. The web **Login** screen displays.

Direct connection with IPv4 auto-configuration

1. If available, use the LCD to verify that the rear Ethernet port is configured to acquire an IP address automatically.
2. Connect an Ethernet cable to the rear port of the controller and your computer. Your computer must be configured to obtain an IP address automatically.
3. Use the LCD to determine the IP address that has been automatically configured. The IP address should use the dotted-decimal format: 169.254.XXX.YYY.
4. Enter this IP address into the address bar of your web browser and press enter. The web **Login** screen displays.

Direct connection with an IPv6 link-local address

1. Connect an Ethernet cable to the front or rear port of the controller and your computer. Your computer must also be configured to allow IPv6 addresses to be used.
2. Use the LCD to determine the IPv6 address that has been automatically configured. The IP address should use the colon-hexadecimal format: fe80::www:xxx:yyy:zzzz
3. Enter this IPv6 address into the address bar of your web browser and press enter. The web **Login** screen displays.

Direct connection with default static IPv4 address

Contact your IT department if you are unsure of how to do this.

1. Connect an Ethernet cable to the front port of the controller and to your computer. Your computer must be configured with a static IP address (e.g. 10.10.10.202) and subnet (e.g. 255.255.255.0).
2. Use the LCD to verify that the IP address for the front port is similar to your computer's IP address (e.g. 10.10.10.201).
3. Enter the CXC HP's IP address (e.g. http://10.10.10.201) into the address bar of your web browser and press enter. The web **Login** screen displays.

4.2.1. In-Shelf Controller

Some systems may have an in-shelf controller display. They do not require a login. The display enables you to execute a set of commands much like the LCD screens on the CXC HP.

From the dashboard, use the **Select** button to enter a menu. When you enter a menu, the top item is highlighted. To go to another menu scroll through using the **Forward** and **Back** buttons. To execute a highlighted menu item, press the **Select** button.

To set a default system or disable USB maintenance actions go to **Controller > Configure Controller > User Interface Preferences > In-Shelf Controller Display Preferences** table from the web interface.

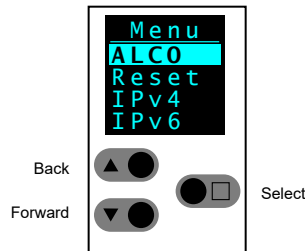

4.3. Navigating the CXC HP User Interface

Both the web and the LCD dashboard provide a summary of system, controller and alarm information. When you login to the web interface or the LCD, the dashboard provides an at-a-glance view of the overall system(s).

4.3.1. Logging in to the Controller

You can login to the CXC HP via the LCD or the web interface.

If the IP address has not been configured, see the previous section, *Connecting the Controller*.

1. Enter the default IP address into the web address bar on the laptop.
2. Log in to web interface.

From the **Login** page Enter the User name and Password

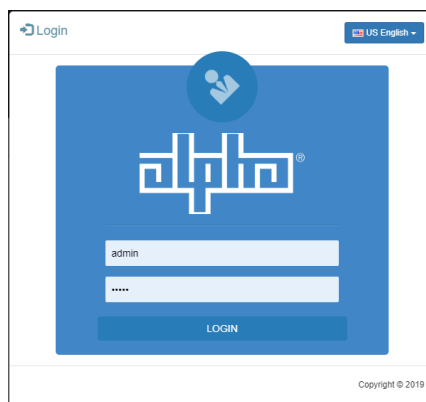

- a. Enter the default User Name: admin (or the user name supplied by your administrator).
- b. Enter the default Password: admin (or the password supplied by your administrator).

 **Note:** Once logged in, the session expires after 3 hours, or after 60 minutes with no activity.

Log in to the LCD interface:

3. From the main dashboard of the LCD, press **Login**.

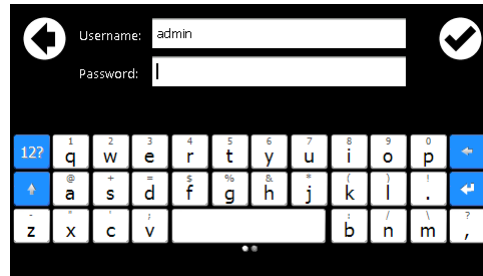

- a. Enter the default User Name: admin.
 - b. Enter the default Password: admin.
4. Press the check mark to complete the login process.

The main dashboard displays.

4.3.2. Controller Menu Map

The following is an overview of the menu structure for the controller displaying paths from the main dashboard.

Figure 6. Menu Structure

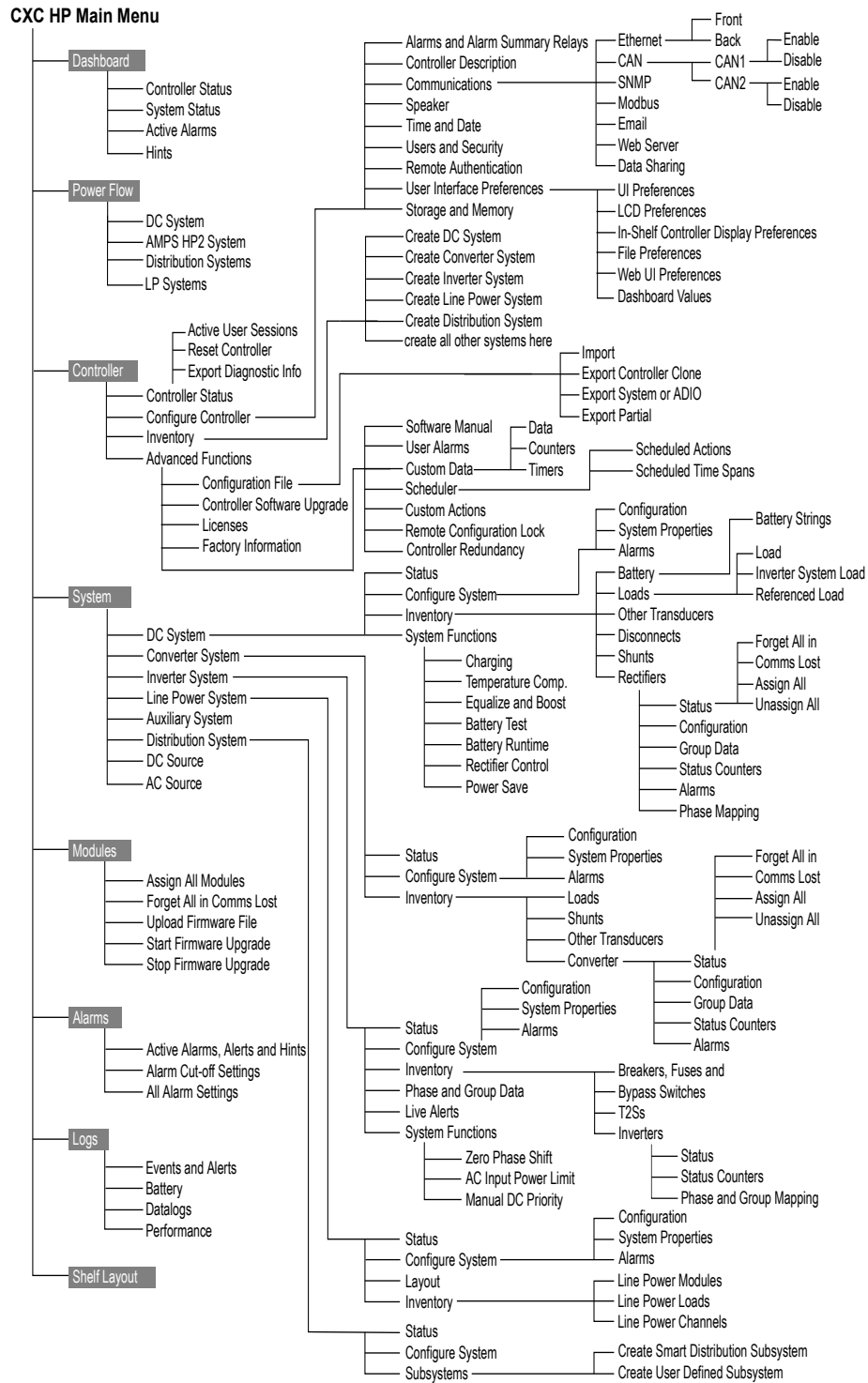

4.3.3. Overview of the LCD Interface

The LCD screen is a touch-sensitive color panel on the front of the controller. The display is always on when the controller is first powered up but after 20 minutes of inactivity the user will be logged out and the display will be turned off. Touching the home button or the LCD in any spot reactivates the LCD screen.

It is possible to change the inactivity time-out of the LCD in the **Controller > Configure Controller > User Interface Preferences** menu. The time-out can be set to 20 minutes, 1 hour, 4 hours, or 8 hours. However, to prevent the LCD screen from wearing out, it is strongly recommended to leave this setting at 20 minutes, unless temporarily changing it for commissioning or demonstrations purposes.

The LCD is most responsive to touch when firm, substantial pressure is applied. The LCD screen does not usually respond to light, quick taps. A stylus may be used if desired.

The default screen that displays on the controller when it is powered up and running normally, is called the dashboard. See the following figure.

Figure 7. CXC HP Controller Dashboard

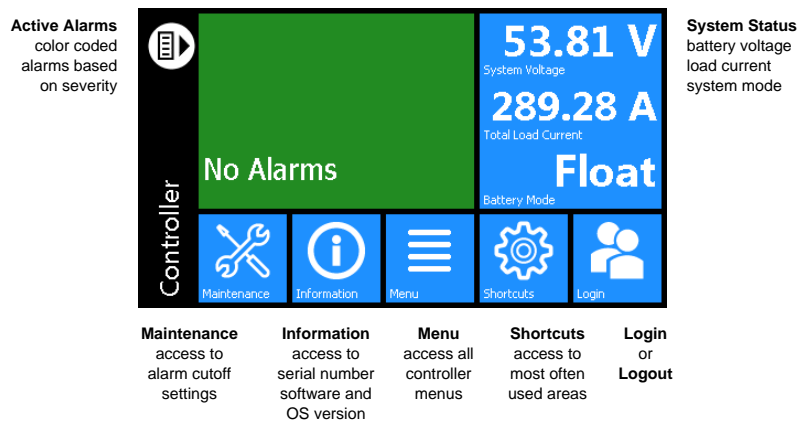

The upper-left area of the dashboard is the **Alarm** tile. If there are active alarms the LCD will show the top three active alarms.

If there are no alarms in the system, the LCD displays **No Alarms** and the display will be green in color. If there are active alarms the color will match the state of the highest priority alarm as follows:

- Green for okay, no alarms present
- Yellow/orange for minor alarms
- Red for major and critical alarms

Pressing the **Alarm** tile takes you to the **Active Alarms** menu to see a list of active alarms, active alerts and hints. From the **Active Alarm** view, you can also activate the alarm cutoff (ALCO) as well as press the individual alarms, alerts and hints to get detailed information on each.

Note:

Alarms, alerts and hints have specific definitions:

- *Alarm: has user configuration and can send email or SNMP notifications*
- *Alert: status from modules like rectifiers or converters*
- *Hint: information about system activity or possible configuration problems; can be dismissed*

The upper-right area of the dashboard is the **System Status** tile. It displays battery voltage, total load current and the Battery Mode of a DC power system. Pressing the **System Status** tile takes you to the shortcuts pages for that system, if it exists, or the status page for that system.

For support of controllers that manage multiple power systems, there is a configuration option which allows the dashboard to shrink the alarm tile to show an extra System Status tile.

Below the **Alarm** and **System Status** data tiles there are five buttons providing access to the rest of the controller's functionality.

Maintenance: Provides easy access to frequently-needed maintenance tasks including the Alarm Cut-Off. Pressing the Maintenance button takes you to the Maintenance screen. The first page contains general shortcuts, like **Alarm Cut-Off**, **Forget All in Comms Lost** and **Replace ADIO**. Each system defined is also listed on the main page. Pressing a system button provides access to a page of system-related maintenance shortcuts.

Figure 8. Maintenance Page

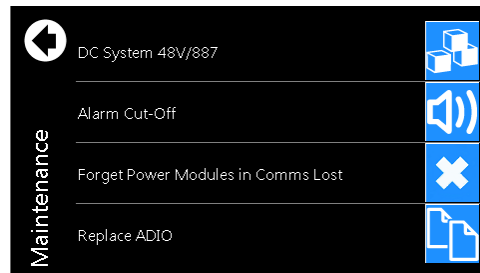
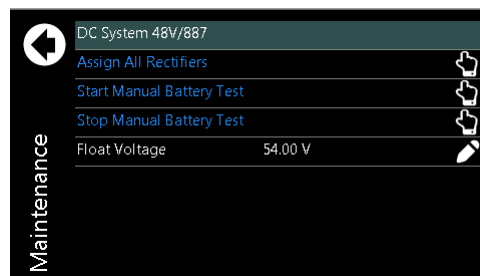

Figure 9. System Maintenance Page



Information: Provides contact information for technical support, as well as general information about the controller such as the serial number, software version, and Operating System (OS) version.

Menu: Provides access to the controller menu, which follows almost the same menu structure as the web interface. Some examples of menus not available on the LCD are:

- SNMP configuration
- Shelf layout

Shortcuts: Provides quick access to several key functions that are used often, such as the **Ethernet** settings. The **Shortcuts** menu also provides access to functions **ONLY** supported via the LCD such as:

- USB file browser
- Backup
- Restore
- Display Calibration

4.3.3.1. LCD Menu Button

This section provides an overview of all the LCD menus on the controller. The LCD touch screen has a menu structure that mirrors the web interface. Click the **Menu** button on the LCD dashboard to navigate and select menu items. The menu items are as follows:

- Controller
- System
- Modules
- Alarms
- Logs

When a menu item is selected, it is highlighted in blue, and an **arrow** displays on the right side of the screen. Click the arrow to navigate to the next screen.

Figure 10. LCD Menu

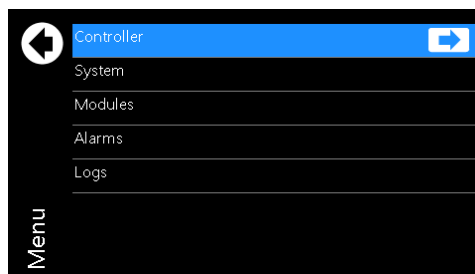

For example, press the **Menu > Controller > Controller Status** to view detailed information about the controller.

Figure 11. Controller Status

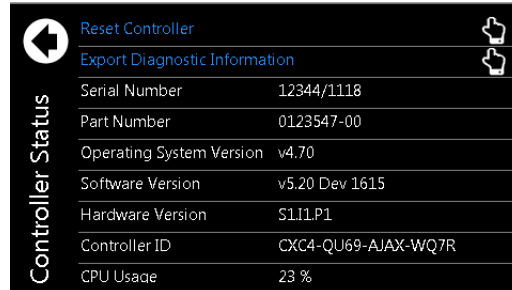

Controller Status		Reset Controller	Export Diagnostic Information
Serial Number	12344/1118		
Part Number	0123547-00		
Operating System Version	v4.70		
Software Version	v5.20 Dev 1615		
Hardware Version	S1I1.P1		
Controller ID	CXC4-QU69-AJAX-WQ7R		
CPU Usage	23 %		

When selected, some views display a **pencil** or **hand** icon on the right side of the screen which means you can edit settings or perform actions.

For example, from the **Controller > Controller Status > Configure Controller > Time and Date** screen click the **pencil** icon to set the following:

- Current Time and Date
- Time Zone
- Daylight Saving Time Method
- Network Time Server Address

Figure 12. Time and Date

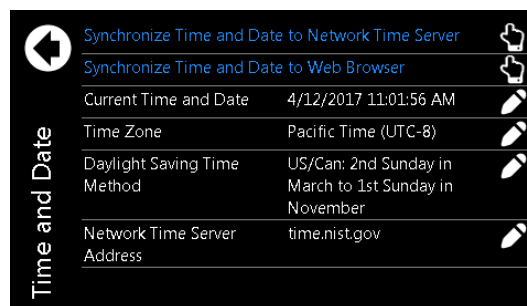

Time and Date		Synchronize Time and Date to Network Time Server	Synchronize Time and Date to Web Browser
Current Time and Date	4/12/2017 11:01:56 AM		
Time Zone	Pacific Time (UTC-8)		
Daylight Saving Time Method	US/Can: 2nd Sunday in March to 1st Sunday in November		
Network Time Server Address	time.nist.gov		

To edit the Timezone, you can choose from the list of supported timezones.

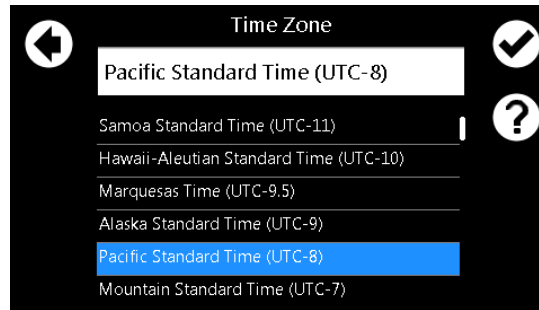
Figure 13. Timezone

If Network Time Server Address is selected, a text field, and on screen keyboard displays.

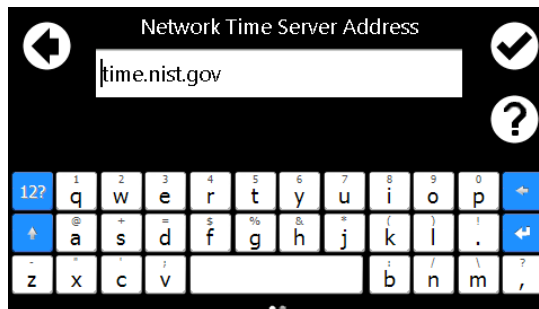
Figure 14. Network Time Server

Clicking the **back arrow** cancels an edit, clicking the **check mark** accepts the changes. Clicking the **Help** icon displays a help screen with more information about the item. If the edit is unsuccessful an error displays in red text below the text box. You can either try again, or click the back arrow to abandon the change.

Another screen that displays when clicking items, is the **Execute** screen. For example, **Synchronize Time**. Most edits and executable actions (except ALCO and Restart) require you to login. If you click an editable item or executable action before logging in, the controller responds providing an opportunity to log in and then continue with the action.

When you click the **back arrow** the action is canceled. If you click **Execute**, the command is executed, and the controller provides feedback on whether the action was successful.

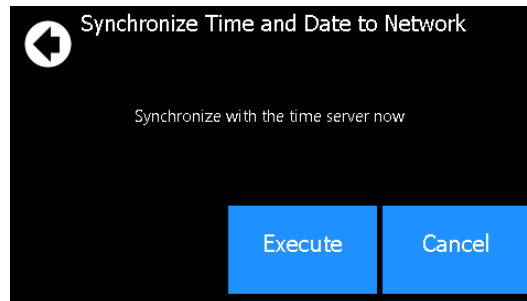
Figure 15. Synchronize Time

4.3.3.2. LCD Shortcuts Button

The LCD Shortcuts menus provide quick access to often-used areas of the controller menu, as well as additional functionality not available via the standard menus.

Figure 16. Shortcuts

Functions available through the **Shortcuts** menu are as follows:

Ethernet: Provides access to the **Controller > Configure Controller > Communications > Ethernet** view, and displays information for each Ethernet port. Viewing and editing the Ethernet configuration is one of the most often-used features from the LCD screen. Selecting an Ethernet port from the list allows you to view and edit the detailed information for that port.

Figure 17. Ethernet

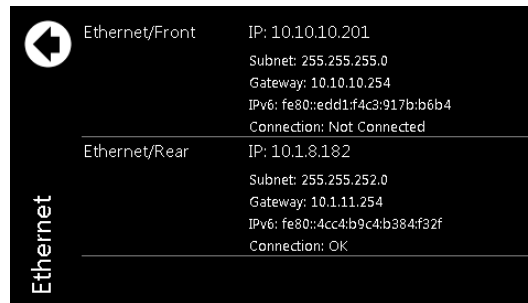

Inventory Summary: Provides access to a special **Inventory Summary** view, which allows for a quick check of what devices are available. The top-level inventory screen shows counts of each device type. Clicking the icon associated with that device displays a list of that type of device. Selecting an individual device from the list displays that particular device’s details.

Figure 18. Inventory



Dashboard Config: Provides a shortcut to the **LCD Preferences** page which provides the opportunity to switch the dashboard configuration between Automatic and Manual and also to change the LCD screen default between a two-panel view, three-panel view or a wide-data panel display. The three-panel view has a single top alarm, and provides two system status data panels, which allows data points for two different systems (for example, DC and Converter) to be shown in the case of a multi-system configuration. The wide data panel view allows you to display six signals from a single system.

In Automatic mode, the dashboard shows a single panel view if there is one system, and a dual panel view if there are two systems.

In Manual mode a user can select the option to have the LCD main dashboard display only a single system, even if there are two installed.

Figure 19. Dashboard with Multi-system Panels

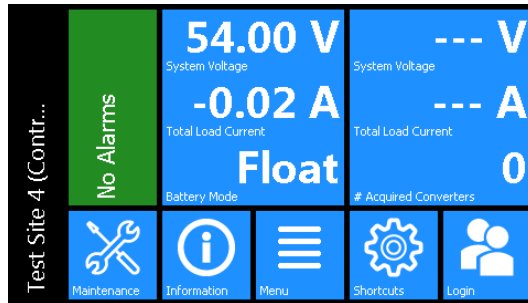
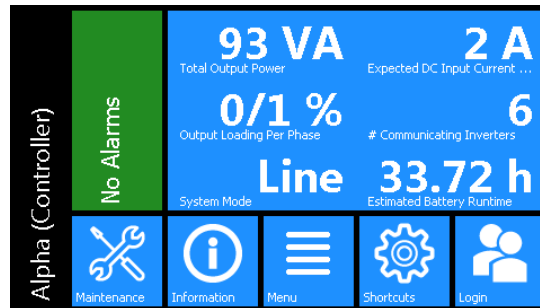

Figure 20. Dashboard Using Wide Data Panel View



To access the wide data layout, go to **Controller > Shortcuts > Dashboard Config > LCD Dashboard Option > Wide Data Panel**. If there is more than one system on the controller. Switching to Wide Data Panel from “Automatic” is a two-step process. Once Wide Data Panel is chosen, a specific system must be selected so that the data values display for that specific system.

Language: Provides access to the **Controller > Configure Controller > User Interface Preferences > Language** screen, where the language for the LCD can be changed to any of the available translations.

Figure 21. Language



Browse USB: Provides access to an LCD-only function, which allows you to view the files on any USB drive that may be attached to the controller. If a file is selected from this view, the LCD goes to the available action screen for that file – for example, the LCD displays an upgrade screen if an application file is chosen from the USB.

Note: When using a USB drive with the controller, use a v3.0 (or later) USB drive for best reliability. Once inserted, it can take up to 20 seconds for the controller to recognize a USB drive.

Figure 22. Browse USB

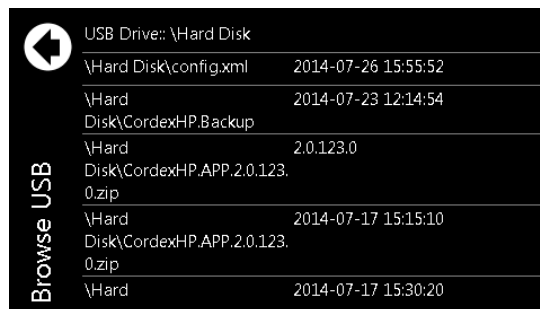

Export Diag. Info.: Provides an option to export a Diagnostic Information Package containing important logs and a controller clone to a USB. This information is needed for any support requests. For more information on how to download, refer to the Exporting Diagnostic Information section of this manual.

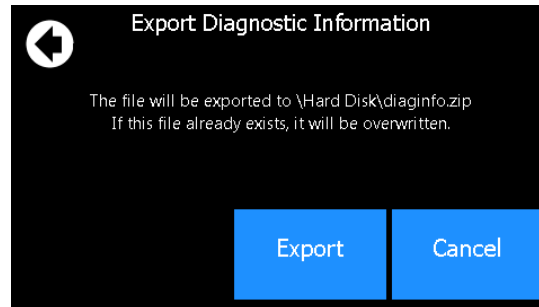
Figure 23. Export Diagnostic Information

Backup: Provides access to an LCD-only function. Clicking this button, allows you to do a back-up of the system. It backs up the application, as well as the config file. These backups are stored in a Cordex HP. file system and are saved on a USB drive.

Note: For the backup to work properly, only one USB drive should be attached at backup time. If a file named Cordex HP.Backup already exists in the root directory of the USB drive, it is overwritten with the current backup.

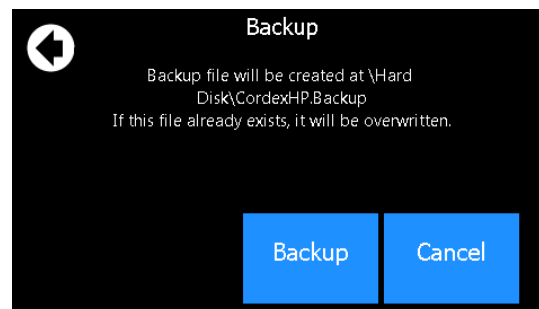
Figure 24. Backup

Restore: Provides an opportunity to insert a USB and restore a previously saved backup file.

Clock: Provides a direct link to the Time and Date screen.

Speaker: Provides the ability to enable or disable the speaker.

Display: Provides the ability to re-calibrate the touchscreen.

Note: When recalibrating the touchscreen display, the final screen of the wizard will say: **Press the Enter key to accept the new settings. Press the Esc key to keep the old settings. Press the touchscreen anywhere to accept the new settings. If using a keyboard, you have the option to press the ESC key to keep the old settings.**

Reset: Provides a direct link to reset the controller.

4.3.4. Overview of the Web Interface

The dashboard is the default view displayed when you login to the controller via the web. It provides an up-to-date overview of most critical information of your system. It displays controller information, a system summary table, and the list of any active alarms.

The upper-left tile of the screen provides a color-coded live status view of these alarm notifications. The upper-right tile provides a system status bar with detailed information about the system(s).

If there are active alarms, the **Alarm Notification** tile displays the last active alarm according to alarm priority:

- Red for major or critical alarms
- Amber for minor alarms
- Blue for warnings

Clicking the Alarm tile takes you directly to the **Active Alarms** menu.

If there are no active alarms, a **No Alarms** message will be shown. In some situations, the controller will provide hints as to certain behaviors of systems, or mis-configurations. If there are no alarms, one hint may be displayed below the **No Alarms** message. Hints are explained in more detail in later sections.

The upper-right tile displays **System Status Bar(s)** which contains summary information for the system(s). Clicking the system link at the top of the **System Status Bar(s)** takes you directly to the **System** status screen.

The upper right-side of the of the web interface also provides the **Login** and **Language** drop down menus. From the language drop-down menu you can change the language from English to other languages as well as choose imperial or metric measurement units for the display.

Figure 25. Dashboard Overview on Web Interface

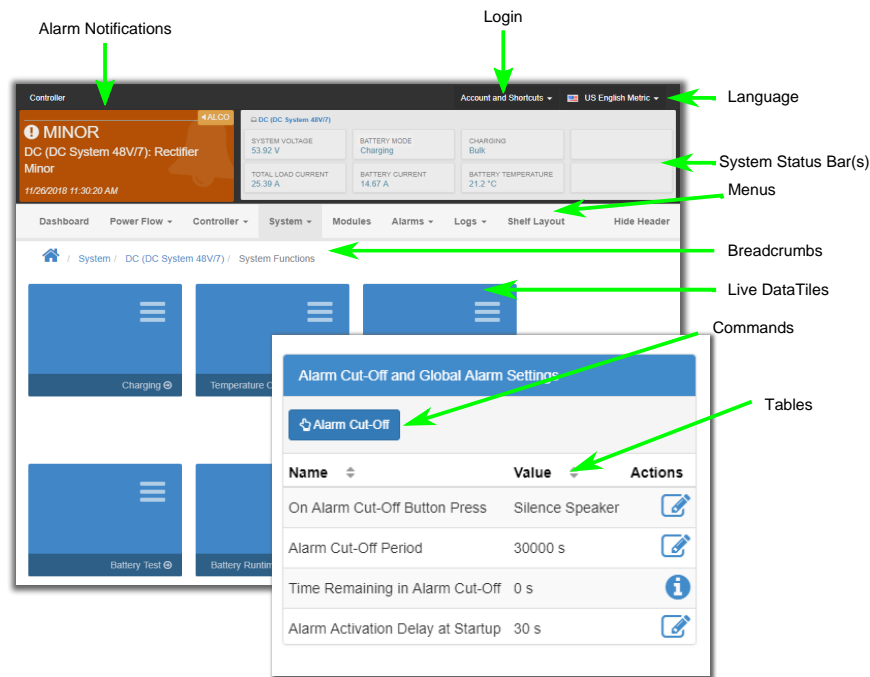

Under the **Alarm Notification** and the **System Status Bar** are the main menus for the controller:

Dashboard (Home), Controller, System, Modules, Alarms and Events, and Shelf Layout.

As you enter the menus, the interface provides a context sensitive breadcrumb trail at all levels so that you can “see” where you are within the system and go back to any previous menu. The lower area of the main dashboard contains system tables with detailed information about:

- Controller Status
- System(s)
- Active Alarms

You can work with the system directly from this area.

Figure 26. Main Dashboard Tables

The screenshot shows a dashboard with four tables. The first table, 'Controller Status', lists system information like OS version, software version, hardware version, controller ID, memory usage, CPU usage, CPU delay, time since restart, and current time. The second table, 'DC System 48V/3038', shows system voltage, total load current, system number, battery mode, battery conditioning, and charging status. The third table, 'Converter System 48V-24V/8375', displays system voltage, system number, total output current, voltage error, converter current difference, and maximum allowed current difference. The fourth table, 'Active Alarms', lists two bus state alarms with their activation times, priorities, and statuses.

On each line of the table, the right-side displays an icon. There are three different types of icons.

Figure 27. Table Icons

The right-side of every table provides three types of icons.



Edit: provides a details field that allows you to edit values and change parameters.



Help: provides a variety of information which may include a description of the feature, its function and the typical default values.

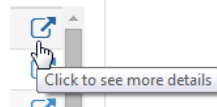

Click to see more details: takes you into the menus and provides more detailed information on the specific line that was clicked

4.3.4.1. Global Search- Web

Within the web interface, there is a search bar at the top-right of the screen. This search bar allows you to quickly find the following information:

- Configuration
- Alarms
- Buttons

To search, enter terms into the search box. After the search returns a result, you can click on **Go To View** to go to the view the status of that Configuration, Alarm, or Button. For **Configuration**, you can click **Edit** to directly edit this value.

The following example illustrates the usage of the search bar to find the **Output Voltage Low** alarm for a DC System.

Figure 28. Global Search Example

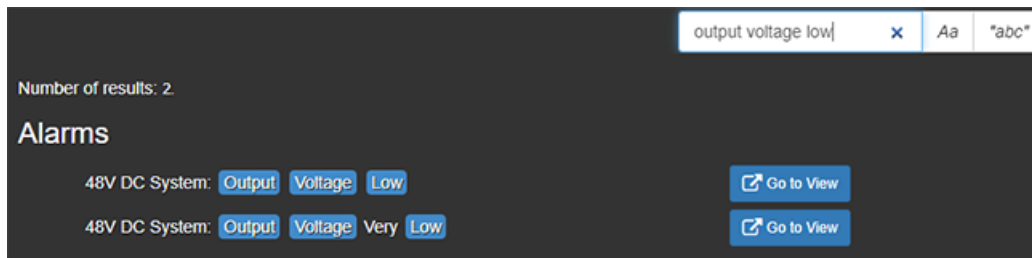

4.3.4.2. Paging, Sorting and Filtering - Web

Within the web interface there are three additional features that help you find information: paging, sorting and filtering.

Paging: displays multiple page tabs on tables that have a large quantity of information. If there is too much information for one table the table's lower edge contains a list of numbers which allows you to scroll through the information.

Sorting: provides a way to sort the table columns, either ascending or descending similar to any standard spreadsheet program.

Filtering: provides an easy way to refine the information shown in a particular table.

The search bar on the upper-left side performs a search on each of the space-separated terms in all columns of the table. The "Aa" toggle can be used to make the search case-sensitive, and the "Abc" toggle can be used to only match whole words. For example, typing "dc system major" will display all alarms of priority Major on the DC System.

The following example shows these features on the **All Alarm Settings** table.

Figure 29. Web Interface Table Features

Name	Status	Limit	Priority	Relay	Actions
48V DC System: Output Voltage Very High	Inactive	56.50 V	Major	---	[Icon]
48V DC System: Output Voltage Very Low	Inactive	46.50 V	Major	---	[Icon]
48V DC System: Invalid System Voltage Reading	Inactive	5.00 V	Major	---	[Icon]
48V DC System: Long Term AC Input Fail	Inactive	10.0 min	Major	---	[Icon]
48V DC System: Rectifier Fail Count Very High	Active	1	Major	---	[Icon]
48V DC System: AC Input Fail	Inactive		Major	---	[Icon]
48V DC System: Battery On Discharge	Inactive		Major	---	[Icon]
48V DC System: Load 1: Load Breaker/Fuse Open	Inactive		Major	---	[Icon]
48V DC System: Battery Disconnect: Disconnect Inhibit	Inactive		Major	---	[Icon]
48V DC System: Battery Disconnect: Disconnect Pending	Inactive		Major	---	[Icon]

4.3.4.3. Controller Menu - Web

This section provides an overview of the **Controller** menu. The controller area has a total of four sub menus in the form of live data tiles: Controller Status, Configure Controller, Inventory, and Advanced Functions.

Figure 30. Controller Menu

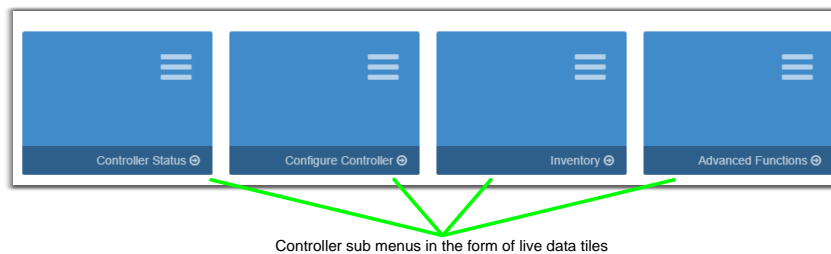

Controller sub menus in the form of live data tiles

Controller Status: Provides the ability to reset the controller and view critical controller related information.

Configure Controller: Provides access to configuration sub-menus including the following:

- Alarms and Alarm Summary Relays
- Controller Description
- Communications
- Speaker (if available)
- Time and Date
- Users and Security
- User Interface Preferences

Inventory: Provides a Inventory table displaying configurable list of systems as well as buttons to manually create or remove them.

Figure 31. System Wizards

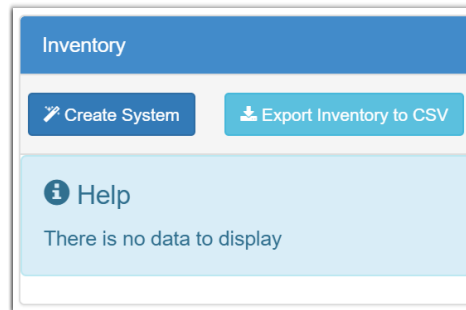

Advanced Functions: Provides sub menus for viewing details and working with advanced functionality, including:

- Configuration File
- Controller Software Upgrade
- Licenses
- Factory Information
- User Alarms
- Custom Data

4.3.4.4. System Menu - Web

This section provides an overview of the **System** menu. Depending on your system configuration, the power system menu area may have several sub menus in the form of live data tiles (e.g. a DC System and a Converter System). If the controller is new, and a system hasn't been created yet, the web page displays the following information.

Figure 32. Controller with No System Configured

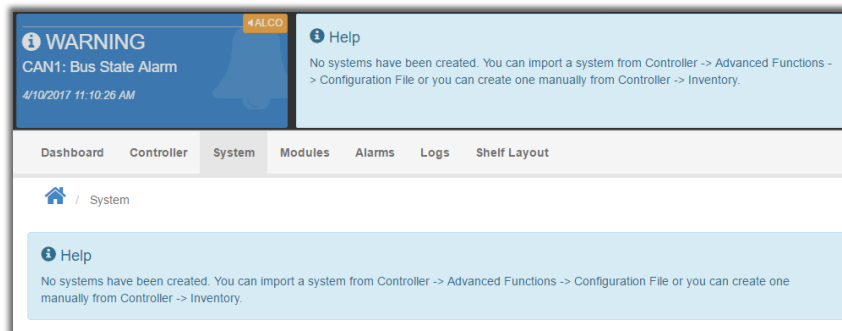

If systems are already configured, they display under the **Systems** menu.

Figure 33. Systems Data Tiles

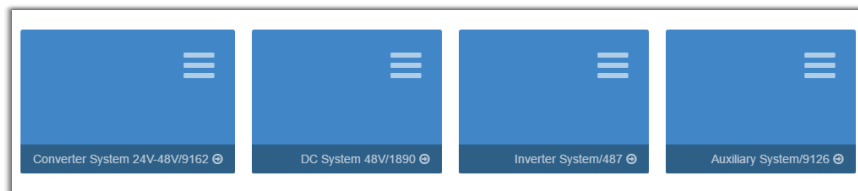

Most systems will have additional sub menus in the form of live data tiles such as: **Status**, **Configure System**, and **Inventory**. Some systems will also have a **System Functions** sub menu as shown here.

Figure 34. System Menu

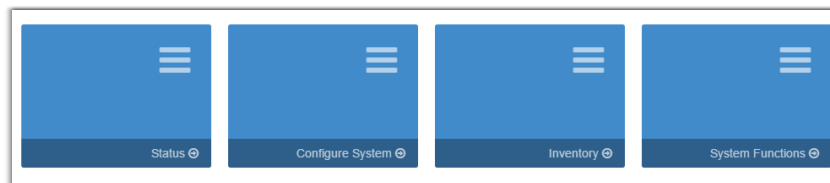

Status: Provides a view of the system's general details.

Configure System: Provides system configuration, system properties and system alarms.

Inventory: Provides six sub menus to do add, remove or configure inventory times, e.g.:

- Rectifiers
- FXM HP
- Battery
- Loads
- Disconnects
- Shunts
- Other Transducers

System Functions: Provides sub menus to manage how the system operates, e.g.:

- Charging
- Temperature Compensation
- Equalize and Boost
- Battery Test
- Battery Runtime and Health
- Rectifier Control and Monitoring
- Power Save

4.3.4.5. Modules Menu - Web

This section provides an overview of the **Modules** menu.

The **Modules** menu has the following tables: **All Modules**, **Firmware Upgrade**, and **Firmware Files**.

Figure 35. Modules Menu

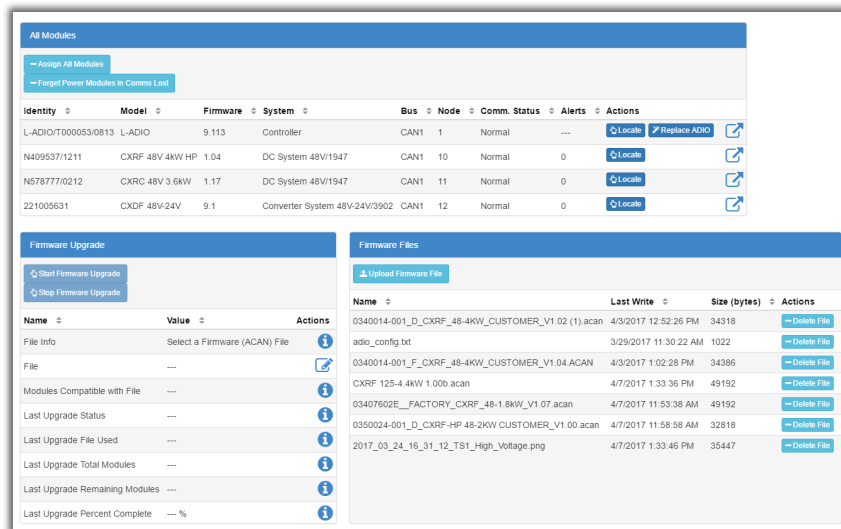

All Modules: Provides a table to view or locate all modules.

Firmware Upgrade: Provides a table to start and monitor a firmware upgrade.

Firmware Files: Provides a table to view, upload or delete firmware files.

Note: Even if a system is configured to auto-assign devices, once a rectifier has been unassigned from the system, it must be manually reassigned back into the system. This is necessary to avoid unintentional auto-assignment. If a device is unassigned using the **Forget** button, then it will auto-assign when discovered on the CAN bus.

4.3.4.6. Alarms Menu - Web

The alarms section has three sub menus: **Active Alarms**, **Alarm Cut-Off and Global Alarm Settings**, and **All Alarm Settings**.

Figure 36. Alarms Menu

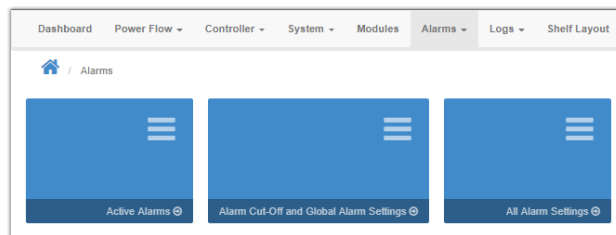

Active Alarms: Provides tables to view and configure **Active Alarms** as well as an **Alarm Cut-Off** button.

Alarm Cut-Off and Global Alarm Settings: Provides alarm cut-off functionality, configuration and settings for global alarm behavior.

All Alarm Settings: Provides a table to view and configure all possible alarms including relay mapping to alarms.

4.3.4.7. Logs Menu - Web

The logs section has a total of four sub menus in the form of live data tiles: **Events and Alerts**, **Battery**, **Datalogs**, and **Performance**. Every log can be exported to .csv files for further analysis.

Figure 37. Logs Menu

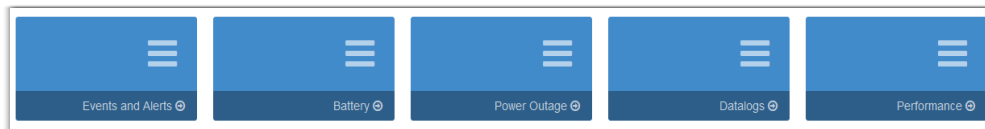

Events and Alerts: The **Events** table provides a list of system and controller events that record configuration changes, alarms and general controller and system operation. The **Module Alerts** table shows the module alert name and module serial number when a module reports an alert condition.

Battery: The battery log records the duration and change in capacity (Ah) for every charge and discharge of a battery. If you have Battery Runtime and Health enabled, the log will also record the change in State of Charge (SOC) and State of Health (SOH).

Power Outage: The power outage log records the start time, end time and duration of each power outage.

Datalogs: The datalog allows users to record measurements at set intervals over a period of time using the CXC HP sensors and calculated values as inputs.

Performance: The performance log provides daily roll-ups with a minimum, maximum and average value for key usage statistics. For power systems, that usually includes the input voltage and current and the output voltage and current. For the controller, the CPU and memory usage are tracked.

4.3.4.8. Shelf Layout Menu - Web

The **Shelf Layout** page displays a virtual view of your shelf layout system. To display the physical representation of a system, a device must provide the bay/shelf and slot ID information.

Figure 38. Shelf Layout Menu

Shelf	Slot 1	Slot 2	Slot 3
1	⚡ 0.00 A	⚡ 0.00 A	⚡ 0.00 A
2	⚡ 0.00 A	⚡ 0.00 A	⚡ 0.22 A
3	⚡ 0.06 A	⚡ 0.00 A	
4			

From the **Shelf Layout**, you can click on any of the devices to be taken to the device details page.

The following modules support the **Shelf Layout** function:

- Cordex HP 12kW 48Vdc
- LPS36
- eLimiter+
- AIM 2500

If all the devices in a system do not have Bay/Shelf/Slot ID information then the view will switch to a simple table with each device on a separate row.

Refer to your device manual to determine whether your device(s) support this feature.

Configure Shelf Layout

The **Shelf Layout** page has a button called **Configure Shelf Layout** for DC Systems and Converter Systems. If all the modules of your system have Bay/Shelf/Slot ID information, the button will appear on top of the system's shelf layout. Otherwise the button will appear on the simple table of modules.

To map your modules to the **Shelf Layout**:

1. Click on **Configure Shelf Layout** to launch the **Configure Shelf Layout** page
2. On the module you wish to map, press the **Locate** button under the **Actions** column. The physical module will begin to blink.
3. On your physical layout, locate the blinking module and make a note of the slot position.
4. On the **Shelf Layout** page, drag the module from the System table to the appropriate shelf/slot position on the layout grid.

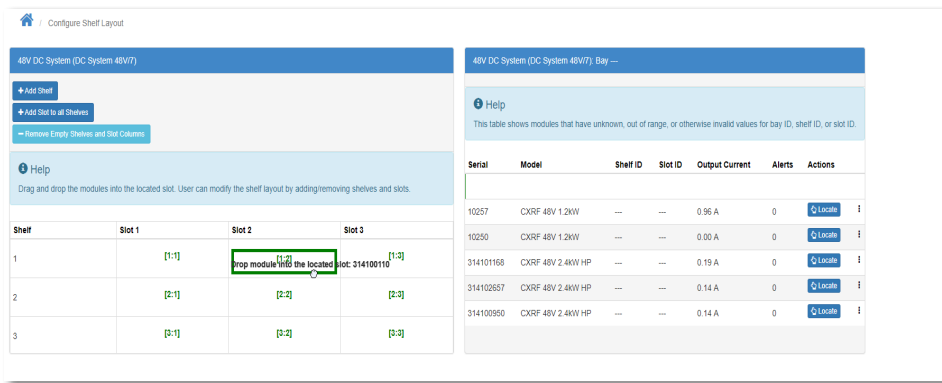

- To remove a module from the layout grid, press the red “X” icon. The module will return to the system table.
- Repeat the steps above until you have mapped all your modules.
- After you have mapped all the modules, go to **Shelf Layout** on the main menu and you will see the completed shelf layout grid.

If you click on a module in the layout, you will be taken to the details of the module. In the details page, you will see that the Bay/Shelf/Slot ID information is set to where you dropped the module.

4.3.5. Overview of the In-Shelf Display

CXC HP in-shelf controllers have a small organic LED (OLED) display. This displays shows 30 characters total (six characters wide, five lines high) and the controller has three navigation buttons and one reset button.

In-Shelf Display: Screens

The in-shelf display has three main operating modes: dashboard, menu and screen saver. After 20 minutes with no activity, the in-shelf controller goes into screen saver mode and the display shuts off. From screen saver mode, press any of the three navigation buttons to re-activate the screen and enter dashboard mode.

In dashboard mode, the in-shelf display shows the key operating parameters of a system. For example, output voltage and load current. If more than one system is defined, you can cycle between systems using the **Forward** and **Back** buttons. With multiple systems, you can specify a default system, which is then displayed first.

To set a default system, from the web interface, go to the **Controller > Configure Controller > User Interface Preferences > In-Shelf Controller Display Preferences** table.

The following figure below shows examples of the OLED screens.

Figure 39. In-Shelf Controller Dashboard Screens

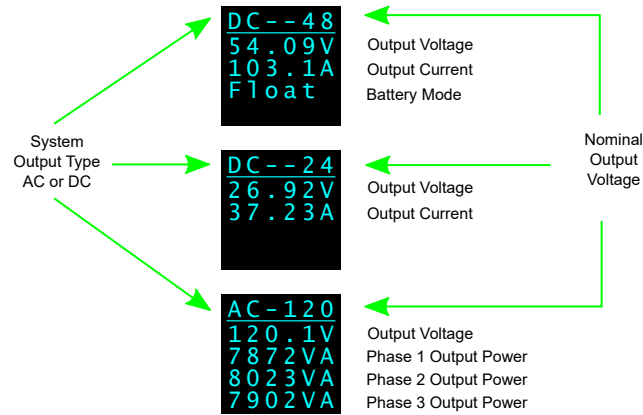

In-Shelf Display: Menu

From the OLED dashboard, use the **Select** button to enter a menu. From the menu, the OLED display lets you execute a set of commands much like the LCD screens on the CXC HP.

When you enter a menu, the top item is highlighted. To go to another menu scroll through using the **Forward** and **Back** buttons. To execute a highlighted menu item, press the **Select** button.

To exit a menu and return to the main OLED dashboard, scroll to the **Back** command, and then press the **Select** button. The figure below shows an example of the menu screen. The following table provides a full list of menus available via the in-shelf display.

Figure 40. In-Shelf Controller Menu



Table 1. In-Shelf Controller Full Menu

Menu Label	Description
ALCO	Perform the alarm cut-off command
Reset	Perform a software reset of the controller
IPv4	Display the IPv4 address, subnet and gateway for this controller
IPv6	Display the IPv6 addresses assigned to this controller
AutoIP	Set the IP to Automatic (obtained from DHCP server)

Menu Label	Description
RstIP	Reset the IP to Static Default (IP: 10.10.10.201, Subnet: 255.255.255.0)
Port	Displays the Port number for the controller
Backup	Backup the controller application and configuration to a file on a USB device
Restore	Restore the controller application and configuration from a file on a USB device
Upgra...	Upgrade the controller application from a file on a USB device
OS Upg	Upgrade the controller's operating system from a file on a USB device
Info	Display controller information including serial number, part number, software and hardware version
Rotate	Rotate the in-shelf controller display information by 90 degrees
Explnv	Export all inventory to USB drive. This is a large file and may take a while to export. The data can be used for analysis in a spreadsheet program.
RemCfg	When Remote Configuration Lockout has been enabled, this menu allows the lockout to be temporarily overridden for a pre-configured amount of time.
Back	Exit the menu and return to the OLED dashboard

In-Shelf Controller: Buttons

The in-shelf controller can be mounted vertically or horizontally. The contents of the display can be rotated, but the buttons cannot be rotated. The following figures show how the buttons are interpreted for both mounting options.

Figure 41. In-Shelf Controller Buttons: Vertical Mount

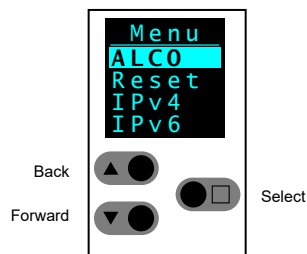
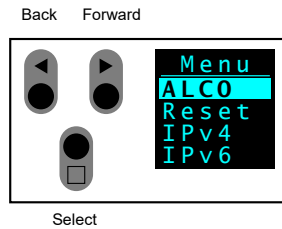

Figure 42. In-Shelf Controller Buttons: Horizontal Mount



4.4. Email Notification

The CXC HP can be configured to send alarm summary emails. In this case the CXC HP is acting as a Simple Mail Transfer Protocol (SMTP) client. This section of the manual describes the features of and how to set up the CXC HP email client.

Figure 43. Default Ports: SMTP Client and Server

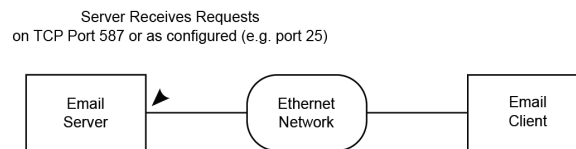

A summary of alarm activities in the controller can be delivered using email. A period of monitoring time is configured, and then all alarms within that period are reported.

This summary is designed to assist decision making when determining the urgency of any action required to resolve issues that may occur in your system.

Table 2. Email Notification Features

Feature	Description
HTML Based Emails	HTML based emails provide better formatting features such as color coding and table alignment.
Multi-level Security	Different security levels are available and automatic detection is executed to support the appropriate level. Direct SSL connection (default port 486) is NOT currently supported.
Encrypted SMTP Server Password	The password used for authentication on the SMTP server is securely encrypted.

Feature	Description
Test Email Capability	A test button is available to send a test email ensuring proper configurations are set for email notifications to reach the appropriate monitors.
Public SMTP Server	<p>We currently support the following public server:</p> <ul style="list-style-type: none"> • Gmail – With less secured connection set in the Gmail account. (OAuth2 protocol is not supported. Please refer to Google developer site for more details. https://developers.google.com/identity/protocols/OAuth2)
Private SMTP Server	<p>The controller supports private servers with the following security settings:</p> <ul style="list-style-type: none"> • TLS • Clear text with authentication • Clear text anonymous

Email Content

- Subject line with filterable text and alarm counts.
- Static title for filtering.
- Configurable name of the controller.
- Configurable location of the controller which provides a link to open Google Maps showing the location of the controller (Internet connection required).
- Time and date of the notification.
- List of up to ten active alarms sorted by priority with an active alarm count indicator showing total active alarms.
- List of up to ten cleared alarms sorted by priority with a cleared alarm count indicator showing total cleared alarms.

How Email Notification Works

- An alarm activity is the main item that will trigger an email notification. To avoid overwhelming the network, emails are only sent out at the configured interval set in the **Email Configuration** page.
- When alarm transitions occur (e.g., alarms activating or clearing) a timer starts from the first transition. During this collection period, all alarm transitions are collected for reporting in the email that is sent out at the end of the period. Continued transitions after the email is sent will start another timer for the next email notification.
- Active alarms are reported as a snap shot of all currently active alarms, regardless of when they activated or if they were a part of a previous notification.
- All cleared alarms are collected based on the last occurrence within the collection period. This is to avoid multiple entries of the same alarm in the case the alarm toggled multiple times.

Secured Email

Connection to a SMTP server defaults to TLS secured connection on port 587. Checks are done via the controller and if TLS is not supported, proper degradation of security features is done in the following sequence:

1. TLS handshake attempt.
2. Clear-text authentication with username and password.
3. Anonymous clear-text transmission with no authentication.

The checks are done by following SMTP protocol for SMTP server commands and responses. Please see SMTP protocol standards for more details.

Table 3. Email Configuration

Configuration	Description
Enable	Email notification defaults to inactive. Enabling allows email notifications to go out when all configuration information is set correctly.
SMTP Server Address	A DNS name or an IP address will work in providing a target location of the email server.
Port	Default port is 587
Domain	This is a DNS formatted string (words separated by '.') used for identifying the client to the SMTP server. Required for most public SMTP servers like Google.
SMTP User Name	The username used for authentication to the server to access SMTP resources.
SMTP Password	The password used for authentication to the server to access SMTP resources. Set this value by using the Set SMTP Server Password button. You can clear the configured password by using the Clear Server Password button.
From	The From field is used as the source of the email and is usually the same as the Username provided to authenticate the client to the SMTP server. For example, Gmail requires this value to be the email address of the account in use.
To	The To field is for the destination or receiver of the email notification. This field allows multiple email address entries separated by commas.

4.5. Setting up SNMP Communication

Simple Network Management Protocol (SNMP) is a standard protocol or language that Network Management Systems (NMS or SNMP manager) use to control network devices and report information.

A typical SNMP system is often represented as one SNMP manager collecting data from several SNMP agents or devices.

The CXC HP acts as an agent or device in an SNMP system. This section of the manual describes how to add a new agent (the CXC HP) to an existing SNMP system. It does not cover how to set up an SNMP manager nor does it explain how to correctly set up an SNMP system. Those topics are specific to the SNMP management software chosen which will have its own documentation.

Figure 44. Default Ports: SNMP Manager and Agent

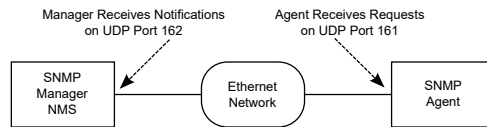

There are two main steps required to add a new agent to your SNMP system:

- Configure the agent with the IP address of your SNMP manager (tell the agent to send information to the manager).
- Compile the agent's Management Information Bases (MIBs) into the manager (tell the manager how to interpret information sent by the agent).

Configuring IP Address to Receive Notifications

Configuring an IP address for notifications is referred to as *Subscribing to Notification Services*. Up to ten IP addresses can be configured. SNMP monitoring systems need to compile and install the ALPHA-NOTIFICATION-MIB. Please refer to the user guide of the SNMP manager for this process.

Figure 45. SNMP Destination Page:

Name	Destination	IP Address	Community	Notification Type
Notification Destination 1	Enabled		public	Unacknowledged
Notification Destination 2	Enabled		public	Unacknowledged
Notification Destination 3	Enabled		public	Unacknowledged
Notification Destination 4	Enabled		public	Unacknowledged
Notification Destination 5	Enabled		public	Unacknowledged
Notification Destination 6	Enabled		public	Unacknowledged
Notification Destination 7	Enabled		public	Unacknowledged
Notification Destination 8	Enabled		public	Unacknowledged
Notification Destination 9	Enabled		public	Unacknowledged
Notification Destination 10	Enabled		public	Unacknowledged

Clicking one of the more details icons on the right-side of the row takes you to an edit page to configure the appropriate fields.

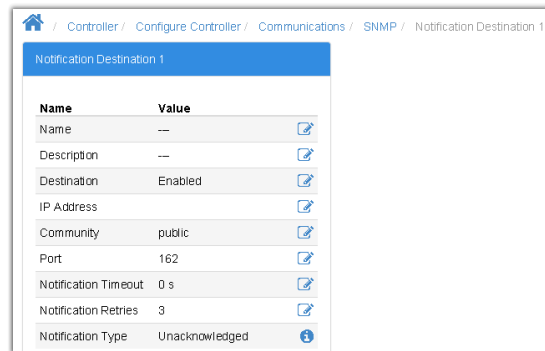
Figure 46. Destination 1 More Information Page:

Name	Value	
Name	--	
Description	--	
Destination	Enabled	
IP Address		
Community	public	
Port	162	
Notification Timeout	0 s	
Notification Retries	3	
Notification Type	Unacknowledged	

Clicking the edit icon on the IP address row allows you to insert an IP address of the monitoring destination.

 **Note:** For detailed information on using SNMP, see the *SNMP Integrator Guide (0350099-J0)* on the Alpha website, www.alpha.ca.

4.6. Setting up Modbus Communication



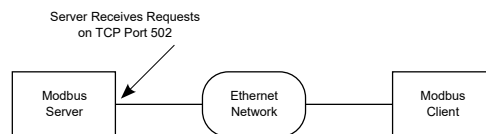

The controller can act as a Modbus server (or slave or agent) in a Modbus system. This section of the manual describes how to enable the Modbus server on the controller. It does not cover how to set up an Modbus master (or client) nor does it explain how to correctly set up a Modbus monitoring system. Those topics are specific to the Modbus master software chosen which will have its own documentation.

Figure 47. Default Ports: Modbus Client (Master) and Server (Slave)

To setup Modbus TCP/IP on the controller, you need to enable the Modbus server via the web interface.

1. Go to **Controller > Configure Controller > Communications > Modbus**.
2. In the **Configuration** table, click the edit icon and select **Enable** from the drop-down menu.
3. Click the edit icon on the **Byte Order** line, and then select the byte order.
4. Device IDs are normally left as the default values.

Figure 48. Enabling Modbus on the Controller

Modbus			System Device IDs		
Name	Value	Actions	Name	Value	Actions
Modbus Agent	Enabled		AMPS HP2 Inverter System/956: Device ID	2	
Byte Order	Least significant bytes first		DC System 48V/314: Device ID	1	
Limited Data Set Device ID	247				

 **Note:** For detailed information on using Modbus, download the *Modbus Integrator Guide (0350114-J0)* on the Alpha website, www.alpha.ca.

5. DC Power Systems

This section provides a brief overview of the components and functions within a typical DC power system. A basic power system usually consists of rectifiers and batteries, but can also include other components.

5.1. Guidelines for Commissioning the DC System

The following section contains basic guidelines for commissioning a DC power system. Overall system commissioning consists of four parts: power system inspection, battery inspection, commissioning the system and testing the system. Commissioning should only be conducted by a qualified technician. For more detailed information refer to the relevant system manual for your specific system.

Perform an inspection of the power system to confirm that the mechanical and electrical requirements and parameters are within specification. Pay special attention to the battery to ensure it is installed safely and correctly, and that the battery terminals are torqued to specification.

1. Make sure all power to the system is off.
Are all batteries disconnected, rectifier modules are removed, fuses pulled and circuit breakers turned off?
2. Make sure the battery polarity is correct. Use a voltmeter if necessary to confirm.
3. Install one rectifier.
4. Turn on the AC to the rectifier and allow it to start up.
Verify that the system starts up, and the controller turns on. Did the rectifier turn on? AC and DC lights on?

 **Note:** *At no load and batteries disconnected, rectifier may have a fail alert. This should go away when load is connected.*

5. Confirm the battery settings on the controller: capacity, charge limit, the Peukert exponent, etc. If there is no means of disconnecting the battery, then the rectifier output voltage should be reduced by using the controller to match the rectifier voltage to the battery voltage to avoid sparks.
6. Check that the battery polarity is correct and turn on the breakers, fuse or circuit breakers for the batteries.
7. Follow the initial battery charge procedure as indicated in the manufacturer's instructions.

The controller and rectifiers are operating normally. There may or may not be active alarms depending on system configuration.

Perform commissioning tests to confirm that the system is operating properly. Specific tests to perform will depend on the system configuration but may include:

- Correct AC input voltage and DC output voltage
- Battery test
- Relay test
- Battery disconnect operation

- Alarm test

5.1.1. The Battery Mode

The **Battery Mode** value, as shown in top section of the web page or in the system **Status** page, indicates the state of the battery in the system.

In a system with a fully charged battery, the **Battery Mode** will be **Float** which indicates the battery is floating.

In a system that is charging, the **Battery Mode** will be **Charging**. The adjacent value either show **Bulk** (battery is charging at constant current) or **Absorption** (battery is in the absorption phase of charging).

In a system that is discharging the **Battery Mode** will either be **Discharging** (AC mains has failed) or **Test Discharging** (battery test in progress).

Figure 49. Battery Mode

DC System @V7r			
SYSTEM VOLTAGE 54.17 V	BATTERY MODE Charging	CHARGING Bulk	
TOTAL LOAD CURRENT 25.54 A	BATTERY CURRENT 14.50 A	BATTERY TEMPERATURE 21.3 °C	

The **Battery Mode** may also be **No Battery** (no battery in the system), **Disconnected** (battery appears disconnected) or **Unknown**. When it is **Unknown** then the controller is busy trying to determine the state of the battery. If this value persists for more than a minute or so, it may indicate that one or more of the following may not be properly configured:

- load current
- battery current
- battery capacity
- system voltage
- battery voltage (it is recommend that system voltage and battery voltage to be configured to read the same)

5.2. DC System Functions

5.2.1. Modules, Inventory and System Functions

To set up a system on the CXC HP, you need to work with modules, inventory and system functions. This section explains these terms which will help you to navigate the CXC HP menu and answer questions such as:

- Why are rectifiers in both the **Modules**, and in the **Inventory** menus, but ADIOs are only in the **Modules** menu?
- Why is temperature compensation in the **System Functions** menu, and not under the **Inventory > Battery** menu?

Modules

A module is a device that communicates information. Most modules in a CXC HP system will be CAN devices such as rectifiers, converters, inverters and ADIOs. Future releases, may have modules such as Ethernet and USB-serial connected modules.

Since the CXC HP can communicate with modules, each module in the system should also have a **Communications Lost** alarm. Most modules are replaceable, because of this there are functions within the system to remove old modules and create new ones. Some modules also have the ability to download reports and diagnostic information via the CXC HP.

Inventory

An inventory item is an item that is directly involved in the flow of power through the system. For example, a rectifier is an inventory item but a controller or an ADIO is not. Other examples of system inventory are: AC source, rectifier, load, battery, disconnect, shunt, DCCT, breaker and power meter. Setting up the inventory of a system focuses on the monitoring, not the control of the system.

You can set monitoring in one of three ways:

1. If the inventory item is also a module, you can communicate with it directly, such as with rectifiers.
2. If the inventory can be measured or controlled via an ADIO, then you can map the inventory to read data through the ADIO, such as with shunts, batteries, current transducers and disconnects.
3. If the inventory item's values can be inferred through a calculation, then you can map the inventory to use that calculation such as with AC sources and DC loads.

System Functions

System functions are the major features of the system. Some examples are:

- Battery charging
- Battery runtime estimation
- Charge current control
- Voltage regulation
- Temperature compensation

Once the inventory is in place to monitor the system, you can configure and test the system functions to ensure that the system is working as intended.

5.2.2. Mixed Rectifier System

You can add any rectifier to the DC system that has the appropriate DC bus voltage. Some of the **System Functions** assume that the rectifiers controlled, and the batteries managed are the only source of power on the DC bus. Those **System Functions** work best with either a single rectifier model or models that have been designed to work together such as, the Cordex 1.8kW and the Cordex HP 2.0kW, or the Cordex 3.6kW and the Cordex HP 4.0kW.

Mixing of other rectifier types is not recommended. If you need to mix other sizes and types of rectifiers you may need to turn off some of the **System Functions** for the DC System. See your system manual

or contact Alpha Technical Support if you encounter this situation and do not have instructions on how to set up the **System Functions**.

5.2.3. Battery Charging

The CXC HP applies a typical three-stage charging cycle including Bulk Charging, Absorption Charging and Conditioning which is sometimes called float charging.

Figure 50. Three-Stage Charging Cycle

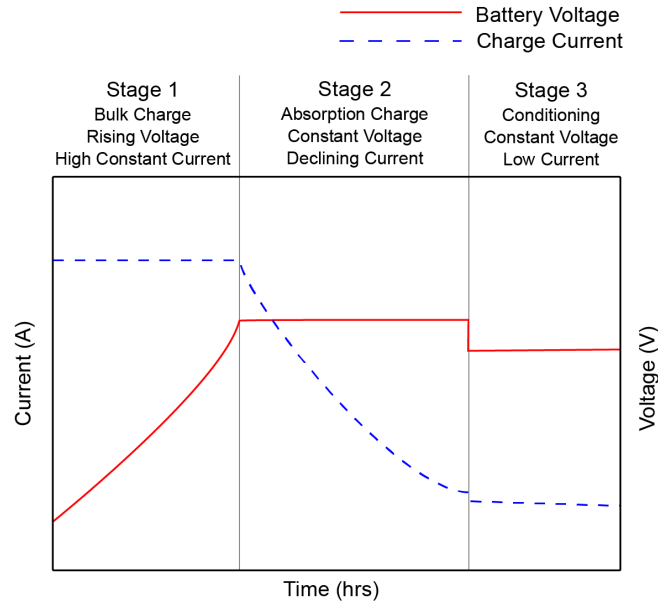

Bulk Charging

After the bulk charging stage, the battery should be in a 70%-90% state of charge. In the **Bulk Charging** menu, you can enable/disable charge current control and set the charge current limit (C/X) in hours.

CAUTION: *If you do not set a charge current limit, the battery may be charged at a much higher rate than is recommended by the battery manufacturer.*

Absorption Charging

After the absorption charging stage, the battery should be in a 95%-98% state of charge. In the **Absorption Charging** menu, you have the option to charge the battery at a voltage higher than the float voltage. The higher voltage is used to speed up the absorption charging stage after a prolonged AC power failure.

Conditioning - Float

The conditioning or float charging stage brings the batteries to 100% state of charge and maintains it there. When the system is in the conditioning stage it is usually at the **Float Voltage**. When the system

is in conditioning-float, a higher **Equalize Voltage** or **Boost Voltage** can be applied from the **System > System Functions > Equalize and Boost** menu.

Conditioning - Equalization

When a string of battery cells or blocks are charged, a single charge current is applied on the group. If the voltages of the cells or blocks begin to differ, the charge imbalance can lead to battery failure. Applying a higher **Equalize Voltage** to a fully charged battery string subjects the stronger cells or blocks to overcharge but this also allows the weaker cells or blocks to regain their full charge. When the voltage is returned to the **Float Voltage**, the stronger cells shed their overcharge and the battery string should be more balanced or equalized.

Applying an Equalize Voltage (an overcharge) to a fully charged battery can also be used to reverse sulfation.

 **CAUTION:** *Applying an overcharge to a battery string also has negative effects on the batteries. See the battery manufacturer's guide to determine whether an equalization voltage should be used at all. If so, what the voltage and the duration should be, and how frequently an equalization charge should be applied.*

Conditioning - Boost

The purpose of boost is similar to equalize - to equalize cells or reverse sulfation. Boost voltage is usually a higher voltage than equalize. In fact it can be too high for the load and therefore require the presence of dropping diodes to be switched into the circuit between the rectifiers and the load to prevent damage to the load. Before boost can be activated, the dropping diodes must be switched into the circuit.

5.2.4. Battery Temperature Compensation

Temperature compensation (Temp Comp) is used to prolong battery life and help prevent thermal runaway. When battery temperature compensation is enabled, the controller uses the battery temperature to calculate an offset which is applied to the battery voltage.

A typical temperature compensation curve for a 48V battery system is shown in the following figure.

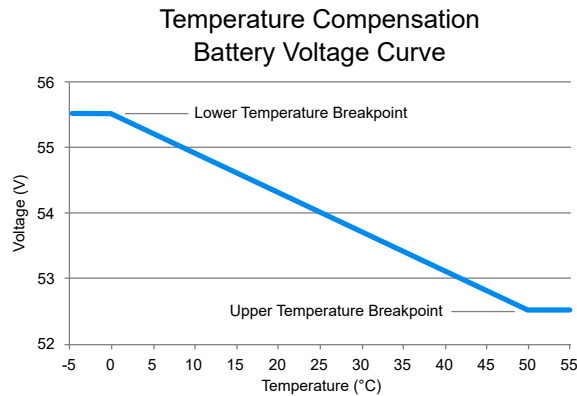
Figure 51. Temperature Compensation Voltage Graph

Battery performance and life expectancy are directly related to the battery ambient temperature. The optimum operating temperature for battery operation is typically 25°C (77°F). Above this temperature battery life may be reduced and below this temperature battery performance may be reduced.

Thermal runaway occurs if the internal temperature rises due to overcharge, high ambient temperature or internal fault. Temp Comp automatically adjusts the float voltage as the battery temperature changes to protect the battery from thermal runaway.

The Temp Comp function adjusts the system voltage every two seconds, as the temperature changes, and provides for a maximum voltage change of 0.1V over this interval. Temp Comp occurs at standard rates commonly referred to as slope-compensation settings.

The slope of the Temp Comp curve in either mV/°F/Cell or mV/°C/Cell can be set via the **System > System Functions > Temperature Compensation**. The value is set based on the battery manufacturer's information.

Since a battery can have multiple temperature sensors, temperature compensation uses the average of the temperature readings to determine the battery temperature on which to adjust the battery voltage. The average is used as long as all the temperature readings are within 5°C (9°F) of each other. When a temperature reading rises, perhaps due to local heating or thermal runaway, and reaches a point when the highest temperature reading is 5°C greater than the lowest temperature reading, then temperature compensation will use the highest temperature reading to determine the compensated battery voltage. This will result in a lower battery voltage and reduce the risk of thermal runaway.

If one or more battery temperature probes appear to be disconnected or broken, then the Temp Comp function calculates the enabled setpoints as if the temperature reached the **Upper Temperature Breakpoint**. This is the safest option in case the failed sensor happened to be the one with the highest temperature reading.

5.2.5. Battery Runtime and Health Estimation

If **Battery Estimation** is enabled, the controller calculates an **Estimated State of Charge (SOC)**, and an **Estimated Battery Runtime** remaining (RTR) at all times. It is not always practical to estimate these

values. For example, if the system goes into a charging stage immediately after a restart, there is no way to estimate the SOC or RTR.

The accuracy of the estimated battery health improves as the battery undergoes more discharge cycles and it also improves with deeper discharges.

If a battery discharge occurs that goes below an SOC value of 80%, then the **Battery Runtime and Health Estimation** function creates a **Last Battery Discharge Summary**, a **Last Battery Recharge Summary** and recalculates the **Estimated Battery Health**. If estimated battery health is less than 80% then that battery is normally due to be replaced.

5.2.6. Low Voltage Disconnect Operation

Whenever the system parameters requires the LVD to be activated, a 60-second countdown and audible warning begins. When the countdown reaches zero, the LVD is activated.

During the countdown, a command in the disconnect menu can be pressed to inhibit LVD activation. When the disconnect first changes to **Pending**, every user logged into the system will receive notification that the disconnect is about to activate, and the option to inhibit it. To release the inhibit, you must activate the release command for each LVD.

Figure 52. Inhibit Disconnect

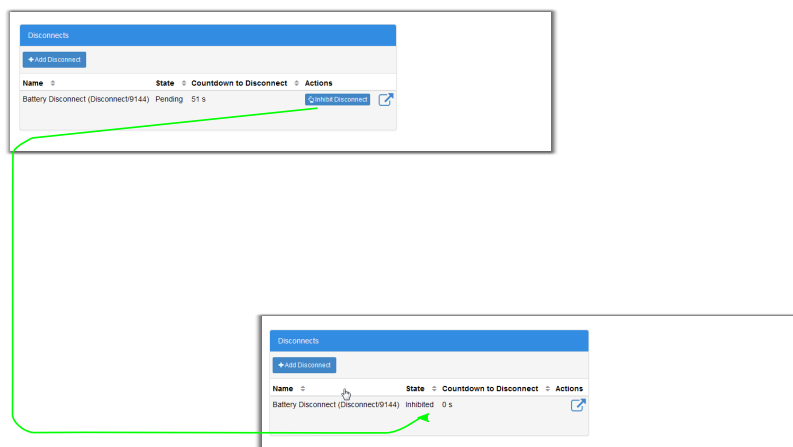

There are two types of disconnects: “legacy” disconnect and a general purpose disconnect.

Legacy Disconnect

The legacy disconnect is the first disconnect available on the controller. It offers the ability to disconnect based on voltage, time elapsed since AC fail, and the state of charge of the battery.

General Purpose Disconnect

The general purpose disconnect is best suited for use as a load shedding disconnect. It can be configured to disconnect based on voltage, or up to three customizable disconnect conditions. There are three customizable reconnect conditions in addition to the usual voltage reconnect threshold.

When using the optional disconnect, note the following conditions:

- the voltage must be less than the disconnect threshold OR
- one or more optional disconnect conditions are true AND
- all optional reconnects must be unknown or false
- if the option to disallow disconnect during battery test is true and battery test is active, the disconnect will not activate until battery test is no longer active or option is disabled.

When using the optional reconnect, note the following conditions:

- the voltage must be greater than the connect threshold OR
- one or more optional reconnect conditions are true AND
- all optional disconnect conditions must be unknown or false
- if the option to require AC for reconnect is enabled and AC input is not present no reconnect will occur until AC returns or this option is disabled.

To better support use as a load shedding disconnect there are three configuration parameters that may be used to further customize the behavior:

1. **Allow Disconnect During Battery Test** - by default this is set to **No** but may be set to **Yes**.
Example: using the battery test to observe and measure the runtime available to critical loads after less important loads are disconnected.
2. **Require AC Info For Reconnect** - by default this is set to **Yes** but may be set to **No**. Example: if there are additional DC sources (like solar panels or a DC generator) on the voltage bus that are capable of supporting the loads even when AC is lost.
3. **Required Time to Stay Disconnected**- by default this is set to 0 seconds. It may be set to a non-zero number in to ensure that a load is fully powered off before reconnecting. Some loads may not start up correctly unless they are fully powered off first.

5.2.7. Battery Test

Battery test mode is used to update the **Estimated State of Health** of a lead acid battery.

Definitions

- Battery Test Termination Voltage — The voltage threshold at which the test normally ends.
- Battery Test Timeout — The maximum time the test can run before it is stopped.
- Battery Test Termination on SOC— Enable or disable the Battery Test Termination SOC threshold to terminate a battery test.
- Battery Test Termination SOC — The State of Charge (SOC) threshold at which the test normally ends.
- Battery Test Alarm — The battery test is active.

Using the Test Discharge (TD) Mode

If the test is started when the battery is fully charged, the results of the battery capacity estimate will be more accurate. Use charge current control to limit the battery recharge current to the battery manufacturer's specified maximum value.

During a test, the **Estimated State of Charge** and **Estimated Battery Runtime** hours can be viewed via the **System > Status** menu or the **System > System Functions > Battery Runtime and Health Estimation** menu.

Test Discharge Initiation

When the test begins, an entry is made in the event log. If the **Battery Test Alarm** has been enabled, it provides a warning to indicate that a battery test is in progress. The output voltage of the rectifiers is set to the Battery Test Termination Voltage to allow the battery to discharge. Battery Mode changes to Test Discharge when a battery test is started.

Test discharge mode runs for the period set as timeout or until the battery test termination voltage is reached or the battery test termination SOC is reached (if enabled).

The rectifiers are periodically scanned to ensure that they do not begin sourcing current. If so then the test is stopped and the battery is recharged.

The rectifier float is reset to the setting that is stored in the system controller. When the system voltage reaches the end (termination) voltage or a timeout occurs, the system controller will command the rectifiers to turn on and enter FL mode.

Activity During Test Discharge Mode

Temperature compensation features are suspended during a battery test. When the battery is discharging, the battery test alarm is active. Battery state of health estimation begins at 3% of DOD, but is not displayed unless DOD > 20%; the point at which reasonable accuracy can be assured.

AC Failure During Test Discharge Mode

If the AC fails during a battery test, the test is aborted. This places the rectifiers into a state that enables them to resume providing power to the load when AC returns. If the runtime is being displayed, it continues to update.

Addition of Rectifiers During Test Discharge Mode

If rectifiers are added to the system when a battery test is active, they are placed into the same state as the current system rectifiers. They are either: placed into battery test state or set to the same voltage as rectifiers already in the system.

Conditions to Watch for During Test Discharge Mode

If the voltage drops below 46V before or when 3% depth of discharge is reached, the test is aborted and the battery health is set to 0% (resulting in a Battery Health Low alarm). This provides an indication that the battery is very weak. Battery state of health must be manually reset to 100% before the next battery test is started, so that the battery monitor can properly estimate the battery health. If rectifiers are sourcing current during the test, and the battery ceases discharging, the test is aborted.

Canceling Test Discharge Mode

Test Discharge mode can be canceled by either changing the mode to Float or stopping the test manually. To stop the battery test manually go to **System > DC System > System Functions > Battery Test** and press the **Stop Manual Battery Test** button.

Battery Discharge Test Completion

Once the battery begins to charge, the recharge cycle begins. Live battery recharge information is available via the **System > DC System > System Functions > Battery Runtime and Health Estimation** menu. The test is considered complete once the battery begins to charge. This is due to either, the test ending from timeout, the system reaching the termination voltage or from an abort condition.

5.2.8. Power Save

When using **Power Save** Alpha recommends the following:

- That the **Power Save** feature only be used on systems with a battery.
- If a system supports 120-240Vac input operation and if operating at less than 208Vac - do not use **Power Save**.
- The current and power capacity settings in **Rectifiers > Configuration** menu should be set to 100% when using **Power Save**.

The **Power Save** feature is designed to improve the efficiency of the system, by optimizing the output power of the rectifiers. Rectifiers that are either loaded too light or too heavy generally have lower efficiency.

Power Save analyzes the system power requirements, as well as available rectifier capacity, determining the optimum loading. Based on the system information the controller then takes rectifiers into or out of standby to achieve maximum rectifier efficiency. Rectifiers in standby do not supply to the load or to battery charging. **Power Save** periodically cycles these rectifiers to ensure they contribute evenly to supplying the load. This balances rectifier operation and maximizes rectifier lifetime.

When active, **Power Save** relies on the battery to briefly take up some of the load current during operation. If there are modules in standby and the load increases, rectifiers supplying power will momentarily have reduced capacity to supply the load. At that point the battery supplies the extra capacity required. **Power Save** detects this and will bring one or more rectifiers out of standby so that the load is fully supplied by the rectifiers.

Power Save has three main tables, **Configuration**, **Status**, and **Modules** tables. The Status table has a Test Rotation Now button which can be used to immediately advance the rotation of the rectifiers. Regularly scheduled rotation will still occur according to the **Module Rotates In** time settings.

To view these tables go to: **System > DC System > System Functions > Power Save**.

Configuration Table

The **Configuration** table has the following fields:

Enable/disable: to set up **Power Save** on a system.

Module Power for Maximum Efficiency: Provides a percentage at which the module should be loaded to achieve maximum efficiency. **Power Save** works to get as close to this value as possible. Refer to the module's installation manual to get information for best performance. If you don't have this information, use the default value based on the rectifiers used.

Rotation Period: Provides the rate of module rotation. The **Rotate One Module Every** value is a length of time in days. After the configured number of days, the module that has been in standby longest will be turned on, the module that has been on the longest will be turned off. Module rotation occurs at 3am.

Status Table

The **Status** table displays which values **Power Save** calculates. These include the following fields:

Power Save: Provides the general status which may be active, disabled, insufficient redundancy or invalid data suspended. **Power Save** cannot operate if in a battery test, if AC has failed or if any required data is unknown.

Average Power: Provides the average module output power computed for the system. **Power Save** will try to get this value as close as possible to the **Module Power for Maximum Efficiency** (set in the **Configuration** table). For example: if the efficiency target is 80%, and the average power is 72% and turning off a rectifier would make the average power 83%, then **Power Save** will turn off a rectifier to get closer to the efficiency target.

Module Rotates In: Provides how many hours left until the next module rotation (always occurs at 3am).

Estimated Time to Rotate All Modules: Provides the estimated number of days until all modules in the system will be rotated. This value changes depending on number of rectifiers and rotation period.

Estimated Required Capacity: Provides the capacity required to supply the load and charge the battery. For example, if your load is 100A and your battery charge current limit is 10A, this value would be 110A.

Estimated Available Capacity: Provides the estimated available capacity of all modules that are **Supplying Power** (modules **In Standby** are not included).

Estimated Redundant Capacity: Provides the estimated extra capacity of all modules that are supplying power in the system. In a system operating in **Float** mode, some modules are **In Standby**, and some are **Supplying Power**. The modules **Supplying Power** may be loaded at 80%. The remaining 20% is considered redundant capacity. This represents rectifier capacity that is immediately available should a rectifier fail. This number can be increased by lowering the **Module Power for Maximum Efficiency** to cause more rectifiers to turn on – it is up to the user to balance the requirement for redundancy vs operating efficiency.

Modules Table

The **Modules** table displays the **Power Save** status of all the modules in the system including: serial number, mode, and **Hours Supplying Power**, **In Standby**.

Hours Supplying Power and **Hours In Standby** is the time a rectifier spent in those modes.

5.3. Creating a DC System Manually

On a CXC HP controller, if there is no power system defined, you can create the inventory items needed to monitor and control a DC power system. There are four steps to creating a new DC System.

1. Verify that the ADIO sensors you are using to monitor the system are working correctly, and document the purpose of each sensor and relay used.
2. Create the DC system and other inventory items, and then configure the inventory to use the ADIO sensors to monitor the system.
3. Configure each of the system functions to correctly control the DC system and manage the battery.
4. Adjust thresholds, enable/disable alarms and set up any remote alarm reporting using alarm relays and/or SNMP notifications.

This section of the manual provides the first steps of how to set up a 48V DC system. For this example, the system is set up as shown in the following figure.

Figure 53. Example of a DC System

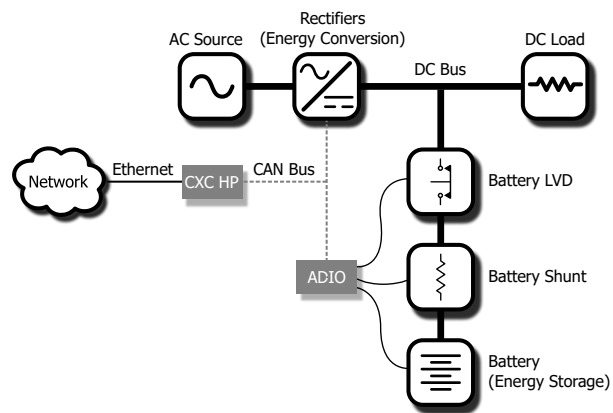

5.3.1. Quick Reference for Configuring a DC System

The following figure shows the key configuration settings for a DC system that should be set or checked so that the system operates correctly.

There are many optional and alarm reporting settings that can also be configured.

Figure 54. Quick Reference for Configuring a DC System

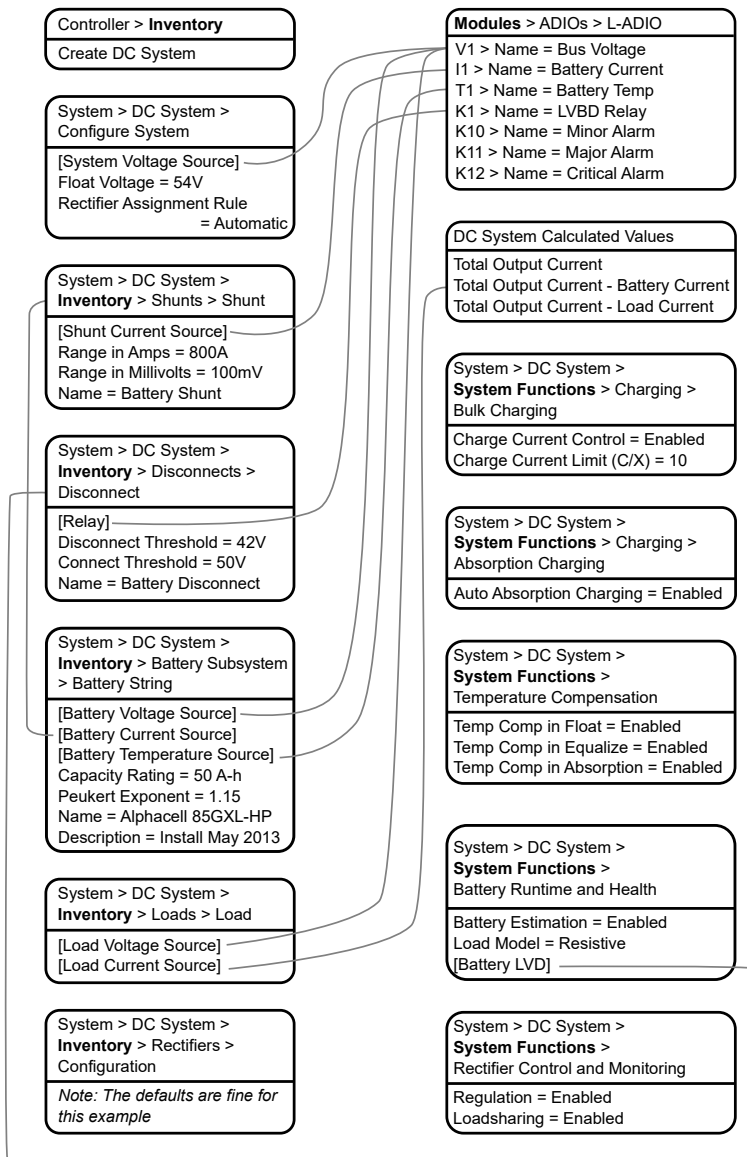

5.3.2. Creating a DC System

There is no DC power system on a brand new CXC HP controller. Creating a DC system is done using the **Create System** wizard. In the current release, only a single DC system is supported, so if a system already exists on the controller, the option to create a new DC system will not be available.

You can also import a configuration file containing a DC system from another controller.

A new power system can be created via the **Controller** menu from either the LCD touchscreen or the web. Both have wizard assistance to help step you through the process to create the new system. You

can create either a 48V system or a 24V system. Once the system is created, an associated load, battery, disconnect, and shunt is also created.

The DC power system will also be created with a reasonable set of defaults and associated alarms. The only value which is mandatory to configure after system creation, is the **System Voltage Source**, which can be set to any voltage input. It is recommended that this be set to the same input as the **Battery Voltage** input. All other items, such as Name, Description, System Number, and Serial Number, are optional and can be used to describe and organize your system.

The **Rectifier Assignment Rule** setting controls how newly discovered rectifiers are treated. The default setting, `Manual`, means that new rectifiers will be grouped into **Unassigned Modules**, and then can be manually added to the system. Alternatively, you can choose `Automatic`, which automatically adds new rectifiers to the system. This is usually the preferred setting.

You can configure the alarms associated with the system. You can enable or disable the alarms, change the priority, map relays to the alarms, and where applicable, modify the thresholds.

To create a DC system:

1. Go to **Controller > Inventory** and use the **Create DC System** wizard.

2. From the results page, click the **Configure DC System** wizard to be guided through system configuration or follow the instructions that follow.

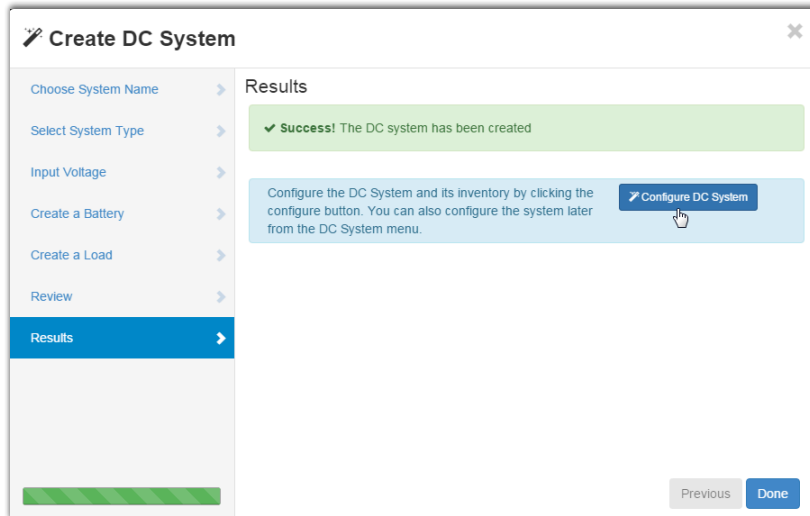

3. Once configured, the Results page will give additional guidance on next steps to take.

Figure 55. Configure DC System Results Page

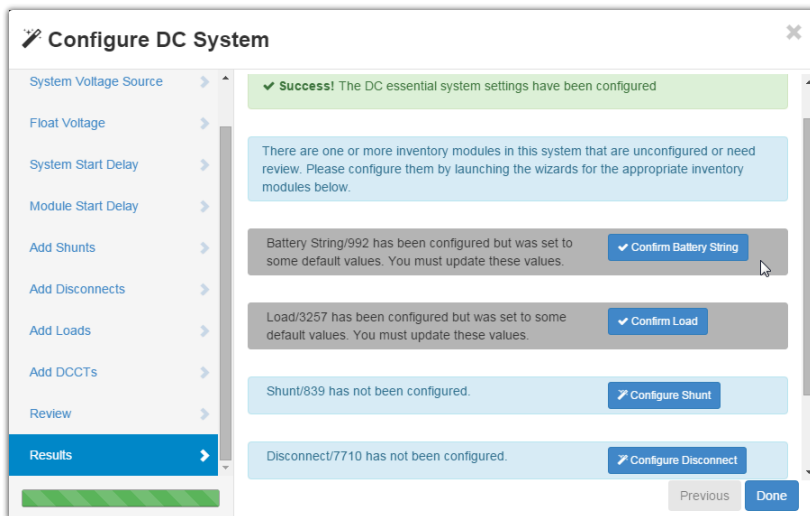

On the **Results** page the wizard provides information on what else needs to be done to ensure the system functions as expected. Any lines coded blue denote action that must be taken, such as in the above example, the **Configure Shunt** and **Disconnect** buttons. The gray coded lines indicate actions recommended, such as in the above example, the **Confirm Load** and **Battery String** buttons. If the item was configured correctly it will display with the line green, meaning no action is required.

5.3.2.1. Creating a System from a Configuration File

A system can be created by importing from a configuration file. See the “Importing a System” section to do this.

5.3.3. Configure the Basic DC System Settings

The Configure system page has three tables (Configuration, System Properties, and Alarms) with some basic settings that must be configured.

From the main dashboard:

1. Go to **System > Configure System**.
2. In the **Configuration** table to do the following:
 - a. Set the system name, description, number and serial number.
 - b. Set the float voltage setting. This is the desired output voltage of the rectifiers when the system is in float mode.
 - c. Set the system voltage source, which is the voltage used to control the system. This is the input of the ADIO that measures system output voltage, and is usually the same input as the battery voltage.
3. In the **System Properties** table, change the **Rectifier Assignment Rule** to **Automatic** which enables the controller to automatically assign rectifiers to this system. Only rectifiers of the type as shown in the **Rectifier Type** field will be added to the system.
4. In the **Alarms** table, configure the alarms.

5.3.4. Configure Dynamic Thresholds for Output Voltage Alarms

Both the High and Low Output Voltage alarms can use a dynamically adjusted threshold. This Adjusted Limit is calculated by adding the difference between the Voltage Regulation Setpoint and the Float Voltage to the configured Limit. To use **Output Voltage Alarm**:

1. Go to **System > DC System > Configure System**.
2. In the Alarms table, click more details for the **Output Voltage** alarm to configure.
3. Use the drop-down menu to set the Absolute or Adjusted field to **Adjusted**.

5.3.5. Configure the Rectifiers

These are settings that include start delay, safe mode voltage or over-voltage protection threshold.

 **Note:** *The Safe Voltage is the voltage that the rectifiers default to if they lose communication with the controller. This feature has a time delay that varies according to rectifier. Most rectifiers revert to Safe Mode after five minutes. Check your rectifier manual for a list of the default parameters.*

Rectifier output voltage is configured from the **System > DC System > Configure System** menu.

To configure the rectifiers:

1. Go to **System > DC System > Inventory > Rectifiers > Configuration**.
2. Set up your rectifier group configuration settings. These include, start delay, safe mode voltage or over-voltage protection threshold.

You can configure the group settings, using information in the following table.

5.3.5.1. Rectifier Configuration Guidelines

The following are guidelines for setting rectifier configuration. Some or all may apply.

Over Voltage Protection Threshold	Set this value as far above equalize voltage or boost voltage as needed. For a 48V system, the usual value is 60V. The actual upper limit of this setting depends on the rectifier model. If the Rectifier Configuration Error alarm is active, it usually means the OVP threshold is too high or too close to the equalize, boost or float voltage setting. It is necessary to have at least 1V (for 48V system) difference between float, equalize and OVP settings.
System Start Delay	Set this value to delay the start up of all rectifiers when AC returns to give other AC equipment on site a chance to start up first.
Module Start Delay	Set this value to apply a staggered start delay to individual rectifiers. This helps limit AC inrush current and gives the controller time to engage charge current control, if enabled, to prevent a battery breaker or fuse from opening. Each rectifier is assigned a module start delay that is a multiple of the configuration value. If the value exceeds 250s, the value starts again at the lowest multiple. For example, if the module start delay is 60s and there are 8 rectifiers in the system, the start delays assigned to the rectifiers will be: 1s, 60s, 120s, 180s, 240s, 1s, 60s, 120s. This means that three rectifiers will be assigned the same 1s, 60s, and 120s delays.
Current Limit/Power Limit	Set one of these values (not both) to limit the output current of the rectifier. This is normally only done if the site has undersized AC breakers or is running on an undersized AC generator. These values must only be set while in float mode. Setting them when the battery is bulk charging may result in too much current to the battery.
Fast Soft Start	Set this to enabled if the system has no batteries and the load does not turn on when AC returns.
CL/PL alert	This is usually disabled when the system has batteries to avoid a current limit or power limit alarm during battery charging.
Ramp Test	This is normally enabled to detect if a rectifier has been disconnected from the load. When enabled and if the rectifier is sourcing less than 2.5% of its maximum current, the rectifier will briefly raise its output voltage by 0.5V (for a 48V system) once per minute. If the rectifier cannot source at least 2.5% of its maximum current, the ramp test will fail and a Rectifier Fail alarm will activate.

5.3.6. Configure the Shunts

By default the system has one shunt. You may add or remove shunts as needed.

To configure a shunt you need an ADIO with current inputs. The shunt will map the current inputs from the ADIO to the **Load Current Source** field of the Load Configuration table or the **Battery Current Source** field of the Battery Configuration table.

To configure a shunt:

1. Go to **System > DC System > Inventory > Shunts**. You will see a list of shunts in the system. Add or remove shunts from this page.
2. Click the more details icon for the shunt you want to configure.
3. In the **Configuration** table, assign the shunt a name and description. Alpha recommends that you assign the shunt a name that represents the actual shunt. For example you might name it **Battery Shunt**.
4. Select the **Shunt Current Source**. This is the current input on an ADIO that takes a voltage reading across the shunt.
5. Enter the **Range in Amps** for the shunt.
6. Enter the **Range in Millivolts** for the shunt.
7. Enter the **Offset Calibration** for the shunt if the shunt reading error is too high.

5.3.7. Configure the Loads

By default the system has one load. You may add or remove loads as needed.

To configure each load:

1. Go to **System > DC System > Inventory > Loads**. You will see a list of loads in the system. Add or remove loads from this screen.
2. Click the more details icon for the load you want to configure.
3. In the **Configuration** table, assign the load a name and a description. Alpha recommends that you assign the load a name that represents the actual load.
4. Select the **Load Voltage Source**. This is the voltage input on an ADIO that takes a voltage reading near the load.

 **Note:** *If you do not have this connected, you can select the input that reads the battery voltage or system voltage.*

5. Select the **Load Current Source**. This is the shunt input that reads the load current. If you have a real shunt reading for the load current, then select the shunt from the drop-down menu. If you don't see the shunt you want, then create it.

If you do not have a shunt for reading the load current, then select the 'virtual' input that calculates the load current by subtracting the total rectifier output current minus the battery current.

6. Click the edit icon for the **Load Breaker/Fuse Source**. Select the digital input on the ADIO which is connected to monitor the breaker or the fuse.

If you need to change the polarity for the **Load Breaker/Fuse Open** alarm, go to the **Modules > ADIO > Digital Inputs** menu.

7. Configure the load alarms.

5.3.8. Configure the Current Transducer

The system, by default does not contain any current transducers. You can add or remove current transducers as needed. To configure a current transducer you need a voltage input on an ADIO. To configure a current transducer with an IPM, you need a shunt input on an ADIO.

To configure a current transducer:

1. Go to the system where you want to add the transducer and navigate to the inventory page. Go to, **System > Inventory > Other Transducers > Current Transducer**. There will be a list of current transducers in the system. Add or remove them from this page.

You may be using a current transducer with **Interface & Power Module (IPM)**. This device takes the voltage reading from a current transducer and divides the reading by 50. The factored voltage reading is then sent to the L-ADIO Shunt Input.

2. Click the more details icon for the **Current Transducer** you wish to configure.
3. In the **Configuration** table, click on **Configure Current Transducer** to enter the configuration wizard and complete the details.
4. Enter the **Measurement Range** in amps.
5. Enter the **Range in Volts**.
6. Select the **CT Current Source**. This can be any voltage source.
7. Optional: enter the **Offset** calibration for the **Current Transducer** if the reading error is too low or too high.

5.3.9. Configure the General Purpose Transducer

The system, by default does not contain any general purpose transducers. You can add or remove general purpose transducers as needed. To configure a general purpose transducer you need a voltage input on an ADIO.

To configure a general purpose transducer:

1. Go to the system where you want to add the transducer and navigate to the inventory page. Go to, **System > Inventory > Other Transducers > General Purpose Transducer**. There will be a list of general purpose transducers in the system. Add or remove them from this page.
2. Click the more details icon for the **General Purpose Transducer** you want to configure.
3. In the **Configuration** table assign a name and a description.
4. Select the **Transducer Input Source**. This can be any voltage source or a custom data.
5. Enter the **Transducer Input Minimum in Volts** and **Transducer Input Maximum in Volts**.
6. Enter the **Transducer Output Minimum** and **Transducer Output Maximum**.
7. Select the **Units and Precision**

8. Optional: enter the **Offset** calibration for the calculated **Value** if the reading error is too low or too high.

The **Calculated Slope** and the **Offset** are used to convert the **Input Source Value** to the **Value**. The value is displayed in the selected units and precision.

5.3.10. Configure the Disconnects

By default the system has one disconnect. You can add or remove disconnects as needed.

There are two types of disconnect, a legacy disconnect and a general purpose disconnect, but each are configured as follows:

1. Go to **System > DC System > Inventory > Disconnects** and click the create **Create Disconnect** button to launch the **Create System** wizard.
2. Both types of disconnects have a name, voltage disconnect and connect thresholds and a relay to map. The wizard for the general purpose disconnect has three extra configurations that can be used to customize the behavior of the disconnect: **Allow Disconnect During Battery Test**, **Require AC Input For Reconnect**, **Required Time to Stay Disconnected**. These extra configurations are most useful when setting up a load shedding disconnect.
3. When the wizard is complete the disconnect is functional but won't have any customizations required for alarming, or load shedding. If further configuration is required, click on the details icon to continue configuration.
4. In the **Digital Inputs for Alarms** configuration table, assign the digital inputs that are used to monitor the state of the physical contactor.
5. In the **Alarms** table, configure the alarms.
6. For the legacy disconnect, it is possible to configure the following additional disconnect options:
 - **Disconnect on Time After AC Fail**- this will open the disconnect after a certain amount of time when AC has failed. This feature is used when configuring a disconnect for load shedding.
 - **Disconnect on Battery State of Charge** table. This feature is used when configuring a disconnect for load shedding.
7. For a general purpose disconnect, it is possible to configure up to three user defined disconnect and reconnect conditions. An optional disconnect condition is configured the way as an optional reconnect condition:
 - **Enable**- if desired, set this to **Enabled**
 - **Value to Test**- set this to a value that the condition should operate on. It is possible to use a **Custom Data** here to added flexibility.
 - **Logic**- select a logical operation: greater than, less than, is True and is False
 - **Limit**- when using greater than or less than, set a number to compare **Value to Test** against.

Ensure that any optional disconnect conditions cannot be true as the same time as any optional reconnect conditions, otherwise the disconnect may get stuck in either the disconnected or reconnected state.

5.3.11. Configure the Battery Parameters

The system is only permitted to have a single battery. The battery may consist of multiple battery strings. When the DC System is being created using the DC System creation wizard, the user will be given the option of adding a battery to the system, or not.

If a battery is required, configure it as follows:

1. Go to **System > DC System > Inventory > Battery**. On the Batteries page, you will see several tables, with Status, Configuration, Alarms, Thresholds, and Temperatures. There is also a table with a list of Battery Strings, and a button to add more.
2. In the **Configuration** table, assign the battery a name and description if required.
3. Edit the **Battery Voltage Source** and **Battery Current Source** if necessary. Note that it is possible to map the entire battery to an ADIO input for the Voltage and Current sources, but is recommended to leave those values at their defaults at this level. The defaults will average the voltages of the battery strings, and sum the currents.
4. In the Battery Strings table, click the **Add Battery String(s)** button to run the wizard which will add more battery strings if necessary.

5.3.11.1. Configure The Battery Strings

A battery string can be configured by editing the necessary values manually, or by running the **Add Battery String(s)** wizard (to create and configure a number of new battery strings), or the **Configure Battery String** wizard to set the configuration of an existing battery string.

The following steps describe how to set the configuration values manually:

1. Click the more details icon to step into the details for each string. Do the following steps on each of the battery strings in your system.
2. Set a **Name** and **Description** for each string, if desired.
3. Select the **Battery Voltage Source**. This is the voltage input on an ADIO that takes a voltage reading as near the battery as possible.
4. Select the **Battery Current Source**. This is the shunt input that reads the battery current. If you have a real shunt reading the battery current, then select the shunt from the drop-down menu. If you don't see a shunt, you should create one now.

If you do not have a shunt for reading the battery current, then select the 'virtual' input that calculates the battery current by subtracting the total rectifier output current minus the load current

5. **Temperature Values** can also be added at either the string level or the subsystem level. See the next section for information on how to do this.
6. Configure the **Capacity Rating**. This value may be available from the battery specification sheet. Use the capacity at the 20-hour rate (C/20).
7. Configure the **Open Circuit Voltage**. This value is may be available from the battery specification sheet. If not, leave at the default value.
8. Use the wizard to configure the **Peukert Exponent**. This value may be available from the battery specification sheet.

If the Peukert exponent (n) is not supplied in the battery specification, calculate it by the equation:

$$n = \frac{[\log(T_2) - \log(T_1)]}{[\log(I_1) - \log(I_2)]}$$

where T is the discharge time in hours and I is the corresponding discharge current in amps. Both T and I are often available in the battery specification sheet.

9. Under the **Breaker/Fuse Source**, select the digital input on the ADIO that is connected to monitor the breaker or fuse.
10. Optional: configure the **Midpoint Voltage Source** if your ADIO is wired to read the battery midpoint voltage.
11. In the **Alarms** table, configure the alarms.

5.3.11.2. Configure Battery Strings Wizard

A battery string can be configured by editing the necessary values manually, or by running the **Add Battery String(s)** wizard.

To add a new battery string:

1. Under the **Battery Strings** table, click the **Add Battery String(s)** button.
2. Under **Battery Parameter Source**, choose the source of battery parameters. You can choose to set the parameters manually, set them based on the battery model, or copy them from an existing battery string. The following steps will assume that you have chosen to set the parameters based on the battery model, as this is the most complex case. Choose **Use Parameters based on Battery Model** and click **Next**.
3. On the **Select Battery Model** page, choose the battery manufacturer and battery model. If yours is not on the list, choose the most similar battery, or go back a step to choose the parameters manually. Once completed, click **Next**.
4. On the **Verify Battery Parameters** page, review the battery parameters. If you have chosen to select these based on a battery model, the values should be pre-populated. The numbers may be edited at this step to make sure that they match your battery string. Click **Next**.
5. On the **Number of New Strings** page, select the number of strings you wish to add, then click **Next**.
6. If you have chosen to add more than one string, you will get be taken to the **Clarify Mappings** page. Clarify the voltage source and shunt information, then click **Next**.
7. On the **Name the String(s)** page, enter a name for each of the new strings, if desired. Click **Next**.
8. On the **Map the String(s)** page you will be able to map a voltage source (either one per string, or an overall voltage reading). You can also map a midpoint voltage for each string and a breaker or fuse source for each string. If you chose to add a current source for each string, that field will also be available to edit here.
9. On the **Results** page which will show whether the addition of the battery strings was successful.

5.3.12. Configure the Battery Temperature Sensors

The battery can have any number of battery temperature sensors. These should be added at the battery string level.

In previous releases, it was possible to add temperature values at the overall battery level. If you upgrade from a release that allowed that and you had temperature sensors at the overall battery level, those will be maintained and can still be used, but no new temperature sensors can be added at that level. You should add new temperature sensors on the individual battery strings.

Adding temperature sensors can be done using the **Add Multiple Temperature Values to Strings** wizard from the overall battery page. Otherwise, they can also be added from the individual battery string pages. Depending on your requirements, you can choose to have only a single temperature reading for your battery, or one for each battery string, block, or cell.

To add and configure battery temperature sensors manually from the battery string pages:

1. Go to **System > DC System > Inventory > Battery**. Click on the details of an individual battery string.
2. On the **Temperatures** table, click the **Add Temperature Value** button. The table will be populated with a new line for temperature value.
3. Click the more details icon on the right-side of the line for the new temperature value.
4. A new page displays with information about the new temperature value. In the **Configuration** table you can enter an optional name and description if desired.
5. It is mandatory to select a **Battery Temperature Source** for the temperature value. Click the more details icon and select the desired temperature input. The drop-down list displays all temperature inputs present on all ADIO devices.
6. In the **Status** table, verify that the temperature is now reading a temperature value.
7. Repeat these steps for each temperature value required. When finished navigate back to the **Battery** page.

Enable the temperature sensor alarms as needed.

8. Go to **Modules**. Select each ADIO you are using, and then view the **Alarms** table. For the temperature sensor you are using, verify that the **Temperature Sensor Failure Alarm** is enabled.

In the **Temperatures** table, you should now see a list of temperature values. The battery **Status** table should show the minimum, average and maximum temperature values as determined from the list of temperatures. The battery **Status** table at the overall battery level will also contain the minimum, maximum, average and active temperatures across all temperatures sensors within the battery, including all temperatures both the strings and the battery itself. At the DC System level, Battery temperature should now show a valid reading on the **System > DC System > Status** page.

5.3.12.1.

To add temperature values using the **Add Multiple Temperature Values to Strings** wizard, follow the steps below.

1. In the first step of the wizard, you can choose whether to add temperature sensors to a single string, or to all of your battery strings. The following description will assume you chose to add to all your strings, but the steps to add to a single string are very similar. Choose **Add the same number of temperature sensors to all your battery strings**. from the drop-down on the first page of the wizard. Click **Next**
2. Choose how many sensors you would like to add to each string. The same number will be added to each of your existing battery strings. Click **Next**
3. In the third step of the wizard, you will be able to map each of these new temperature sensors to a temperature reading from an ADIO, Custom Data, or other calculated temperature value. Click **Next**
4. The temperature readings will be added to your battery strings, and a success or failure message displayed.

5.3.13. Configure the Charging System Function

There is no way to turn off battery charging via the controller, but you can control the bulk and absorption stages.

You can enable/disable charge current control (CCC) in the bulk charging stage. For example, in a situation where multiple power systems are connected to the DC bus and a decrease in current on one system would result in an increase in current on the second system you may want to disable CCC. CCC may be suspended for various reasons. If this is the case the **Charge Current Control State** will say **Suspended** and the suspend reason will be shown in **Charge Current Control Suspended Reason**.

You can enable/disable an increased voltage in the absorption charging state. If you disable **Elevated Absorption Charging** or the arming threshold was not reached, then the absorption charging stage will be done at the float voltage. You can configure **Elevated Absorption Charging** to terminate on a timeout and a low current threshold.

Absorption charging, at an increased voltage, is normally done for deep discharges only so there is an **Absorption Arming Threshold**. A battery discharge must reach a voltage below the **Absorption Arming Threshold** for **Elevated Absorption Charging** to be activated on the recharge.

To configure the charging system:

1. Go to **System > DC System > System Functions > Charging**. Note that you must have a battery defined in the DC System in order to have this menu item available under **System Functions**.
2. In the **Primary Charge Current Control** table, ensure the **Charge Current Control** setting is **Enabled** (this is the default).

Bulk Charging Stage Status			Primary Charge Current Control		
Name	Value	Actions	Name	Value	Actions
Charge Current Control State	Idle	i	Charge Current Control	Enabled	e
Battery Capacity Rating	100 A·h	i	Charge Current Limit Amps	10 A	i
			Charge Current Limit (C/X)	10.0	e

- Set the **Charge Current (C/X)** limit to an appropriate value (for example, 10-hrs). See your battery manufacturers' data sheet for charging recommendations.

Note:

The charge current limit in amps cannot be set to an arbitrarily low value. The charge current control feature uses the rectifier's ability to limit its output current. All rectifiers have a lower limit to which their current can be adjusted and this value is documented in the rectifier hardware manual. For example, if you have 2 x 48-1.2kW rectifiers, they have a minimum current limit of 23% of maximum current. This means the lowest amount of current they can output is $2 \times 25A \times 0.23 = 11.5A$. If the load is 5A, the lowest charge current limit to the battery will be $11.5A - 5A = 6.5A$. A charge current limit of less than 6.5A cannot be achieved with this arrangement.

- From the **Absorption Charging Configuration** table, enable **Elevated Absorption Charging**.

Absorption Charging Stage Status			Absorption Charging Configuration		
<input type="button" value="Start Elevated Absorption Charging"/>					
Name	Value	Actions	Name	Value	Actions
Elevated Absorption State	Disabled		Elevated Absorption Charging	Disabled	
Time Remaining In Elevated Absorption	---		Elevated Absorption Arming Threshold	24.00 V	
			Elevated Absorption Voltage	27.50 V	
			Elevated Absorption Termination Threshold	1.5 A	
			Elevated Absorption Timeout	1.0 h	

- Set the **Elevated Absorption Arming Threshold** to a voltage that indicates a deep enough discharge to warrant absorption charging at a higher voltage.
- Set the **Elevated Absorption Voltage** to a value recommended by the battery manufacturer.
- Set the **Elevated Absorption Termination Threshold** in amps.
- Set the **Elevated Absorption Timeout** in hours.
- Set the **Terminate/Disallow Elevated Absorption When True** setting to either prevent or terminate elevated absorption based on a custom data condition (if desired).

5.3.14. Configure the Temperature Compensation System Function

Temperature compensation uses the battery temperature to adjust battery voltage. The default value for temperature compensation is $-2.5 \text{ mV}/^\circ\text{C}/\text{Cell}$ ($-1.5 \text{ mV}/^\circ\text{F}/\text{Cell}$).

To configure temperature compensation:

- Go to **System > DC System > System Functions > Temperature Compensation**. Note that you must have a battery defined in the DC System in order to have this menu item available under **System Functions**.
- Enable/disable **Temp Comp in Float**, **Temp Comp in Equalize** and **Temp Comp in Absorption**
- Set the **Slope** based on the battery manufacturer's information.
- Set the **Upper Temperature Breakpoint Voltage** to a value below the float voltage.
- Set the **Lower Temperature Breakpoint Voltage** to a value above the float voltage.

6. Adjust the values and enable/disable the **Temp Comp Sensor Fail** and **Temp Comp Voltage Warning** alarms.

5.3.15. Configure Battery Runtime and Health Estimation

The Battery Runtime and Health Estimation is used to calculate **Estimated State of Charge** during charges and discharges, **Estimated Battery Health** for discharges that exceed a 20% depth of discharge (DOD) and **Estimated Battery Runtime** at all times.

To configure battery runtime and health estimation:

1. Go to **System > DC System > System Functions > Battery Runtime and Health Estimation**. Note that you must have a battery defined in the DC System in order to have this menu item available under **System Functions**.
2. From the **Configuration** table, enable/disable **Battery Estimation**.
3. Set the **Load Model**. The load model has no affect on calculating **Estimated State of Charge** or **Estimated Battery Health** but it has a significant impact on calculating the **Estimated Battery Runtime**.
 - a. With the constant current model, the load current is expected to stay the same as the load voltage decreases.
 - b. With the resistive model, the load current is expected to decrease as the load voltage decreases.
 - c. With the constant power model, the load current is expected to increase as the load voltage decreases.
4. Set the **Battery LVD**. If there is no BLVD, this can be left unknown.

5.3.16. Run a Manual Battery Test

Once your DC System is set up, running a manual battery test may be as simple as pressing the **Start Manual Battery Test** command.

1. Go to **System > DC System > System Functions > Battery Test**. Note that you must have a battery defined in the DC System in order to have this menu item available under **System Functions**.
2. From the **Configuration** table, set the **Termination Voltage**, **Timeout** and **Termination SOC** values. Which ever one of these conditions occurs first will terminate the battery test.
3. From the **Status** table, press the **Start Manual Battery Test** command.

To start a battery test, the **Battery Mode** must be in the **Float** mode. Otherwise the battery test cannot start.

There are a number of reasons why the test might terminate early. Two examples are a weak battery detected where the voltage drops too quickly and AC Failure being reported by the rectifiers.

If **Battery Runtime and Health Estimation** is **Enabled** you should see the battery state of charge (SOC) and runtime remaining RTR, update during the test. If the test runs long enough, the test results should be stored in the **Battery Log** page.

5.3.17. Configure Power Save

Power Save works to improve the efficiency of the system by optimizing the output power of the rectifiers. This section describes how to configure **Power Save**.

Power Save should only be used on systems with a battery. If the system supports 120-240Vac input voltage operation and is operating at less the 208Vac - do not use **Power Save**.

1. Go to **System > DC System > System Functions > Power Save**.

The screenshot displays the 'Power Save' configuration page. It is divided into two main sections: 'Status' and 'Config'.

Status Section:

- Buttons: Test Rotation Now
- Table with columns: Name, Value, Actions

Name	Value	Actions
Power Save	Active	[Info]
Average Power	48 %	[Info]
# Modules Supplying Power	2	[Info]
# Modules In Standby	2	[Info]
Module Rotates In	16.9 h	[Info]
Estimated Time To Rotate All Modules	4 d	[Info]
Estimated Required Capacity	34 A	[Info]
Estimated Available Capacity	68 A	[Info]
Estimated Redundant Capacity	17 A	[Info]
Estimated Standby Capacity	74 A	[Info]

Config Section:

- Table with columns: Name, Value, Actions

Name	Value	Actions
Power Save	Enabled	[Edit]
Module Power for Maximum Efficiency	80 %	[Edit]
Rotate One Module Every	1 d	[Edit]

2. In the **Configuration** table enable **Power Save**.
3. Set the percentage of **Module Power for Maximum Efficiency**. The default value is 80%.

For best efficiency performance, refer to the specifications in the module's hardware manual. Ensure this value is below the user configured current or power capacity in the **Rectifiers > Configuration** menu.

4. Set the module rotation period in days. The default is seven days.

Module rotation occurs at 3:00 AM.

5.4. Connecting to Other Systems

The output of a DC System can be used to power DC loads as well as converter and inverter systems. These power systems act as a load on the DC system and you have to represent them as loads on the DC System to ensure the DC System calculations are accurate.

5.4.1. Representing a Converter System as a DC Load

A Converter System is represented on a DC System like an ordinary DC load.

To configure a Converter System as a DC load:

1. Go to **System > DC System > Inventory > Loads**. You will see a list of loads in the system. Add or remove loads from this screen.
2. Click the more details icon for the load you want to configure.
3. In the **Configuration** table, assign the load a name and a description. Alpha recommends that you assign the load a name that represents the actual load.
4. Select the Load Voltage Source. This voltage is the DC input to the Converter System. This is normally a voltage input on an ADIO that measures the DC System voltage.

If you do not have this connected, you can select the input that reads the battery voltage or system voltage.
5. Select the Load Current Source. This is normally the **Converter System > Total Input Current** value.
6. Configure the load alarms.

5.4.2. Representing an Inverter System as a DC Load

An inverter system will normally have an AC input and a DC input. The inverter system may only be using the DC input when the AC input has failed. When the AC input is available, the inverter may take all of its power from the AC input.

On the CXC HP, inverter systems can measure the DC current they are using and they can also calculate how much DC current they are expecting to use, should their AC input fail. The DC System uses both of these values to calculate the battery runtime remaining in all situations.

To configure an Inverter System as a DC load:

1. Go to **System > DC System > Inventory > Loads**. You will see a list of loads in the system.
2. Click the **Add Inverter System Load** to add a new load to the list.
3. Click the more details icon for the load you want to configure.
4. In the **Configuration** table, assign the load a name and a description. Alpha recommends that you assign the load a name that represents the actual load.
5. Select the Load Voltage Source. This voltage is the DC input to the Inverter System. This is normally a voltage input on an ADIO that measures the DC System voltage.

If you do not have this connected, you can select the input that reads the battery voltage or system voltage.
6. Select the Load Current Source. This is normally the **Inverter System > DC Input Current** value which is measuring how much DC current the inverter system is using right now.
7. Select the DC Input Current In AC Failure Source. This is normally the **Inverter System > Expected DC Input Current In AC Failure Source** value which is measuring how much DC current the inverter system is expecting to use should the AC input fail.
8. Configure the load alarms.

6. Converter Systems

This section provides an overview of converters, how they function and how to configure a converter system.

6.1. Introduction to Converter Systems

A DC-DC converter system takes a DC input voltage and converts it to a different output voltage. A converter system provides flexibility that allows you to maintain a single voltage battery system. Converters provide DC-DC power conversion (e.g., from +24V to -48V) to produce a consistent voltage source for equipment that is not compatible with the primary plant voltage. Converters can be used to create dual voltage capability in new systems – or upgrades to existing DC plants. They provide tight voltage regulation for sensitive loads as well as galvanic isolation.

Mixed Converter System

Different types of converters must be used within different converter systems, check your system and rectifier/converter manual(s) for a list of any default parameters or requirements.

Components of a Converter System

A converter system consists of a source, converters and a load as shown in the following diagram. Converters should have dedicated fuse/circuit breaker positions on the main DC power system for protection and isolation.

Figure 56. Example Converter System

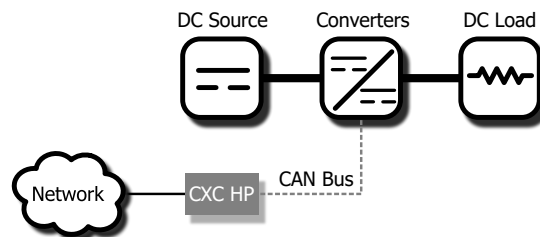

Quick Reference for Configuring a Converter System

Figure 57. Quick Reference for Configuring a Converter System

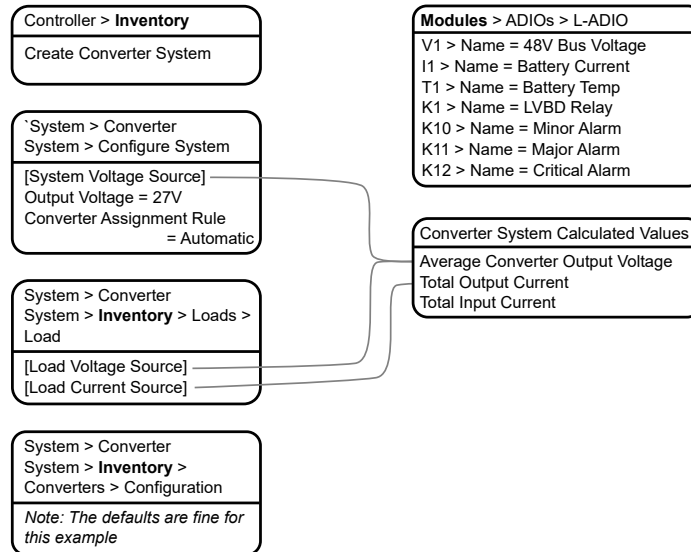

6.2. Creating a Converter System

There is no converter system on a brand new CXC HP controller. Creating a converter system is done using the **Create System** wizard. In the current release, only a single converter system is supported, so if a system already exists on the controller, the option to create a new DC system will not be available.

You can also import a configuration file containing a converter system from another controller.

A new power system can be created from the controller LCD or the web, via the **Controller > Inventory** menu. Both have wizard assistance to help step you through the process to create the new system. You can create either a 48V-24V system or a 24V-48V system. When the system is created, an associated load is also created.

Figure 58. Create Converter System Wizard

The converter system created will have a reasonable set of defaults and associated alarms. Optional converter items, such as Name, Description, System Number, and Serial Number, can be used to describe and organize your system.

The **Converter Assignment Rule** setting controls how newly discovered converters are treated. The two options are **Manual** and **Automatic**. Using `Manual`, groups all new converters into **Unassigned Modules**, and then you can add them to the system manually. Selecting `Automatic` adds new converters to the system automatically. This is the default setting.

You can configure the converter alarms associated with the system. You can enable or disable the alarms, change the priority, map relays to the alarms, and where applicable, modify the thresholds.

To create a converter system:

1. Go to **Controller > Inventory**.
2. Click the **Create Converter System** button. Name the system if required.
3. From the **Select System Type** drop down menu.
4. Step through the rest of the wizard instructions.
5. Use the **Configure Converter System** wizard to configure the basic system settings and the system inventory.

6.2.1. Creating a System from a Configuration File

A system can be created by importing from a configuration file. See the “Importing a System” section to do this.

6.3. Configure the Converters

These settings include start delay, and output voltage or over-voltage protection threshold.

Note:

The output voltage is also the voltage that the converters default to if they lose communication with the controller. The converters will drop any of the adjustments made by the controller to perform load sharing and just try to meet the configured output voltage.

This feature has a time delay that varies according to converters. Most converters revert to output mode after five minutes. check your converter manual for a list of default parameters.

To configure the converters:

1. Go to **System > Converter System > Inventory > Converters > Configuration**.
2. From the **Configuration** table, set up your converter group configuration settings. These include, **System Start Delay** and **Over-voltage Protection** threshold.

Name	Value	Actions
Output Voltage	27.00 V	
Input Voltage Shutdown	42.00 V	
Input Voltage Restart	50.00 V	
Over-voltage Protection	29.00 V	
System Start Delay	10 s	
Current Limit Alert	Enabled	Click to edit

3. Configure the settings for the converters. The values for these settings depend on your specific system.

6.4. Configure the Shunts

By default the system has no shunts. You may add or remove shunts as needed.

To configure a shunt you need an ADIO with current inputs. The shunt will map the current inputs from the ADIO to the **Load Current Source** field of the **Load** configuration table or the **Battery Current Source** field of the **Battery Configuration** table.

To configure the shunts:

1. Go to **System > Converter System > Inventory > Shunts**. You will see a list of shunts in the system. Add or remove shunts from this page.
2. Click the more details icon for the shunt you want to configure.

3. In the **Configuration** table, assign the shunt a name and description. Alpha recommends that you assign the shunt a name that represents the actual shunt. For example you might name it **Battery Shunt**.
4. Select the **Shunt Current Source**.
This is the current input on an ADIO that takes a voltage reading across the shunt.
5. Enter the **Range in Amps** for the shunt.
6. Enter the **Range in Millivolts** for the shunt.
7. Enter the **Offset Calibration** for the shunt if the shunt reading error is too high.

6.5. Configure the Loads

By default the system has one load. You may add or remove loads as needed.

To configure the loads:

1. Go to **System > Converter System > Inventory > Loads**. You will see a list of loads in the system. Add or remove loads from this screen.
2. Click the more details icon for the load you want to configure.
3. In the **Configuration** table, assign the load a name and a description. Alpha recommends that you assign the load a name that represents the actual load.
4. Select the **Load Voltage Source**. This is the voltage input on an ADIO that takes a voltage reading near the load.
If you do not have a sensor connected, you may want to select the **Average Converter Output Voltage**.
5. Select the **Load Current Source**. This is the shunt input that reads the load current. If you have a real shunt reading for the load current, then select the shunt from the drop-down menu. If you don't see the shunt you want, then create it.
If you do not have a shunt for reading the load current, you may want to select the **Total Output Current** for the converter system.
6. Click the edit icon for the **Load Breaker/Fuse Source**. Select the digital input on the ADIO which is connected to monitor the breaker or the fuse.
If you need to change the polarity for the **Load Breaker/Fuse Open** alarm, go to the **Modules** menu, from the All Modules table, select the ADIO required, and then click the details icon to access the **Digital Inputs** table.
7. Configure the load alarms.

6.6. Configure the Current Transducer

The system, by default does not contain any current transducers. You can add or remove current transducers as needed. To configure a current transducer you need a voltage input on an ADIO. To configure a current transducer with an IPM, you need a shunt input on an ADIO.

To configure a current transducer:

1. Go to the system where you want to add the transducer and navigate to the inventory page. Go to, **System > Inventory > Other Transducers > Current Transducer**. There will be a list of current transducers in the system. Add or remove them from this page.

You may be using a current transducer with **Interface & Power Module (IPM)**. This device takes the voltage reading from a current transducer and divides the reading by 50. The factored voltage reading is then sent to the L-ADIO Shunt Input.

2. Click the more details icon for the **Current Transducer** you wish to configure.
3. In the **Configuration** table, click on **Configure Current Transducer** to enter the configuration wizard and complete the details.
4. Enter the **Measurement Range** in amps.
5. Enter the **Range in Volts**.
6. Select the **CT Current Source**. This can be any voltage source.
7. Optional: enter the **Offset** calibration for the **Current Transducer** if the reading error is too low or too high.

6.7. Configure the General Purpose Transducer

The system, by default does not contain any general purpose transducers. You can add or remove general purpose transducers as needed. To configure a general purpose transducer you need a voltage input on an ADIO.

To configure a general purpose transducer:

1. Go to the system where you want to add the transducer and navigate to the inventory page. Go to, **System > Inventory > Other Transducers > General Purpose Transducer**. There will be a list of general purpose transducers in the system. Add or remove them from this page.
2. Click the more details icon for the **General Purpose Transducer** you want to configure.
3. In the **Configuration** table assign a name and a description.
4. Select the **Transducer Input Source**. This can be any voltage source or a custom data.
5. Enter the **Transducer Input Minimum in Volts** and **Transducer Input Maximum in Volts**.
6. Enter the **Transducer Output Minimum** and **Transducer Output Maximum**.
7. Select the **Units and Precision**
8. Optional: enter the **Offset** calibration for the calculated **Value** if the reading error is too low or too high.

The **Calculated Slope** and the **Offset** are used to convert the **Input Source Value** to the **Value**. The value is displayed in the selected units and precision.

7. Inverter Systems (Single T2S)

This section provides an overview of inverters, how they function and how to configure a single T2S inverter system.

7.1. Introduction to Inverter Systems

An inverter system takes both AC and 48V DC input and converts it to 120V AC output voltage. The inverter system can operate in one of several modes:

- **Line (AC-AC):** when AC input is present the inverters normally take this voltage and convert it to AC at the output.
- **Inverter (DC-AC):** when AC input is lost, the inverters take the DC input voltage and convert it to AC at the output.
- **Bypass Mode:** when the maintenance bypass switch has been used to bypass the inverters and directly connect the AC input to the output.

To monitor and interact with the inverter system, the CXC HP communicates with up to four sub-controllers called T2S.

7.1.1. Components of a Single T2S Inverter System

An inverter system typically consists of an AC source, a DC source, inverters, an AC load, input breakers, output breakers and a bypass switch. A very large inverter system may not have a bypass switch and will use breakers to perform the maintenance bypass function.

Figure 59. Single T2S Inverter System Components

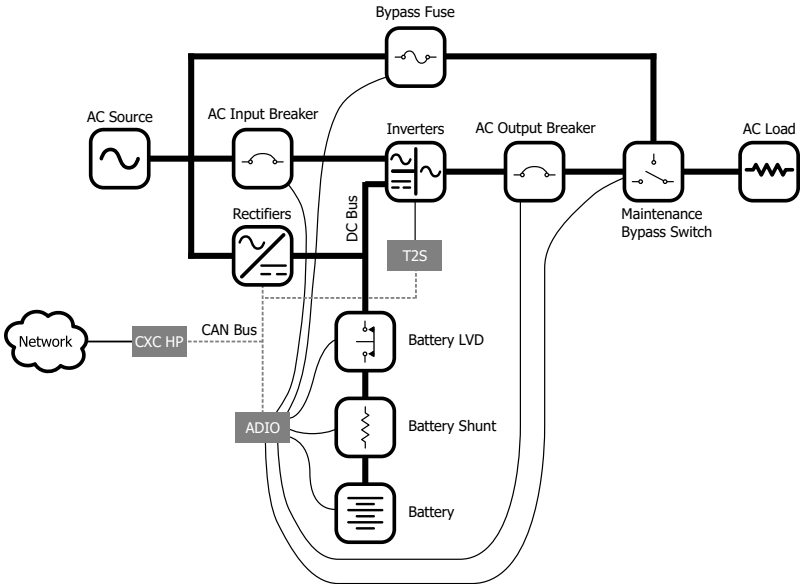

7.1.2. Quick Reference for Configuring an Inverter System

Figure 60. Quick Reference for Configuring an Inverter System

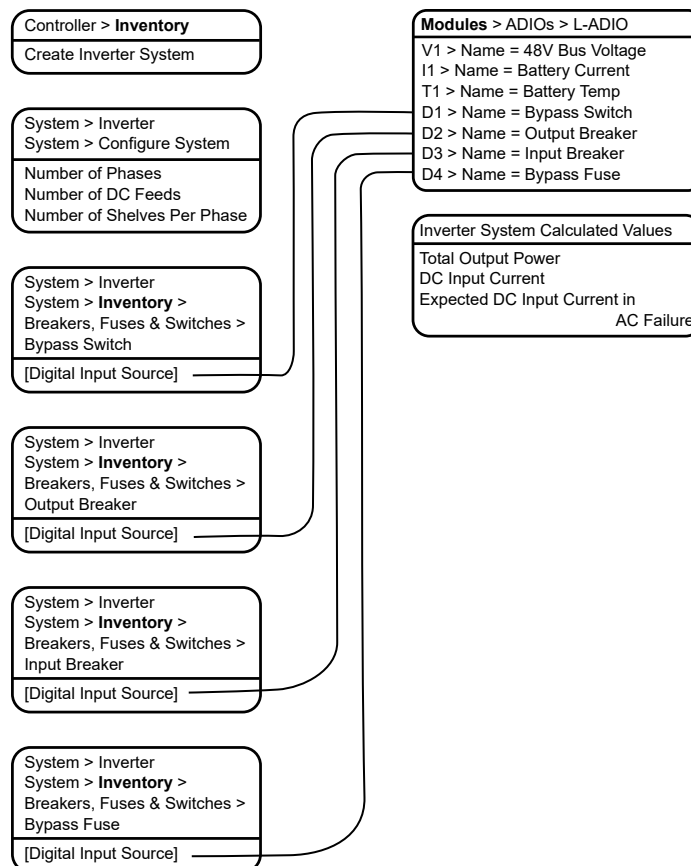

7.1.3. Phase and Group Data

The inverter system will aggregate and display data about the output phases, AC input groups and DC input groups.

The output phase information includes data such as the output voltage, output power (in VA and W), frequency, and loading.

The AC input group information include data such as the input voltage, input power (VA and W), and frequency for each phase (there is a one-to-one correspondence between the phase and AC input group).

The number of DC input groups is the number of redundant DC input sources. An example is a system with separate batteries. The DC input group information includes data such as the DC voltage, current and power (W).

To get information on **Phase and Group Data**, go to **System > Inverter System > Phase and Group Data**.

 **Note:** When the AC output is light (10% or less) or the phases are unbalanced, some of the data, (percentage of DC input, DC input current or AC output power readings) will tend to be inaccurate and inconsistent. This is normal. Once the AC output is loaded sufficiently the readings will be correct.

7.1.4. Live Alerts

The T2Ss in an inverter system report alert status relating to the T2S or its inverters via the **Live Alerts** table. Go to **System > Live Alerts**. The table shows the **Owner** of the alert, the alert **Type** and the **Alert Name**.

The **Owner** of the alert indicates if the alert belongs to the T2S or to a specific inverter.

The **Type** of alert indicates if the alert is an individual T2S alert, an inverter alert or a system alert. A “system” alert is an alert that is active on all inverters. A system alert usually indicates a configuration error or a problem with an input source or an output which is affecting all inverters at the same time.

The **Alert Name** displays the name of the alert as well as a numeric code. This numeric code can be used to cross reference the alert in the T2S log file when troubleshooting.

Additional information about a specific alert can be found in **Alerts** table of the **Owner** identified within the **Live Alerts** table.

7.1.5. System Functions

The inverter system has three functions available:

- Zero Phase Shift
- AC Input Power Limit
- Manual DC Priority

These are briefly described below. For information on using these functions go the Inverter and T2S Maintenance section.

Zero Phase Shift

The output of the inverters is normally shifted from the input by 5 degrees for certain regulatory compliance. For some systems running on generator, it may be necessary to momentarily reduce this phase shift to 0 degrees before any manual bypass operation is performed. A wizard guides you through this operation.

During the wizard, the controller will check the difference between the input voltage and output voltage (as measured line-neutral). This difference is caused by different levels of loading on input or output or unusual AC mains conditions. If the difference is greater than 6V, a warning indicates that proceeding with the bypass operation may result in momentary interruption of power to the load. If the difference is larger than 6V there is a small chance that inverters may shutdown when they detect too much current flowing into the input or output as the bypass switch is turned. If this warning is occurs, wait until input and output are closer together.

AC Input Power Limit

This function can be used to limit the AC input power that the inverter system will take by using some of the energy from a DC bus. If there is only a battery (and no rectifiers) supplying the DC bus, this function must be manually controlled by an operator to ensure the battery is recharged once it is depleted.

Manual DC Priority

This function can be used to take power from the DC bus based on a user-specified percentage. If there is only a battery (and no rectifiers) supplying the DC bus, this function must be manually controlled by an operator to ensure the battery is recharged once it is depleted.

7.2. Creating an Inverter System

There are two options for creating an inverter system:

- Use the **Create Inverter System** wizard via the **Controller > Inventory** menu.
- Use a configuration file to import an inverter system.

After an inverter system is created, it must have one or four T2S devices assigned to it. The T2S is a CAN device that controls and monitors the inverters.

Figure 61. Create Inverter System Wizard

7.2.1. Creating a System from a Configuration File

A system can be created by importing from a configuration file. See the “Importing a System” section to do this.

7.3. Assigning a T2S

Each inverter system requires one or four assigned T2Ss. If the **T2S Assignment Rule** was set to **Automatic** during system creation, then a T2S is automatically assigned once discovered on the CAN bus.

If the **T2S Assignment Rule** was set to **Manual**, go to **System > Inverter System > Inventory > T2Ss**, and then click **Assign** in the **Modules Available for Assignment** table.

 **Note:** *It can take several minutes to discover a T2S on the CAN bus, for the first time.*

7.4. Commissioning a Single T2S Inverter System

 **Note:** *The Commission Inverter System wizard can only be used on systems with one T2S. Systems that have four T2Ss must be commissioned following the detailed procedure in the Inverter Systems (Four T2S) chapter.*

Once an inverter system has been created, and a single T2S has been assigned to the system, it can be commissioned. There are three stages to commissioning:

- Setting the system options
- Commissioning seed inverters
- Adding inverters

Setting System Options

This wizard requests the following configuration information:

- Number of **AC Phases**
- Number of **DC Input Groups**

AC Phases can be set to one, two or three. Refer to the system's connection diagram to determine how many input phases are connected.

DC Input Groups is the number of redundant DC input sources, and can be set to one, two or four. Refer to the system's connection diagram to determine how the DC bus bars have been configured.

 **Important:** *It is important that these values are correct for the proper operation of system commissioning, and for adding new inverters.*

Figure 62. Commission Inverter System Wizard

Commission Seed Inverters

The second stage of commissioning involves inserting one seed inverter for each phase. The seed inverter provides a reference for all other inverters in the same phase so they can learn their power configuration and the phase angle. The commission wizard steps the user through the process. Once this is complete, there will be one inverter (per phase) in the system.

⚠ Warning: Follow all wizard instructions: If a mistake is made during commissioning or the wizard encounters an error, commissioning must start over.

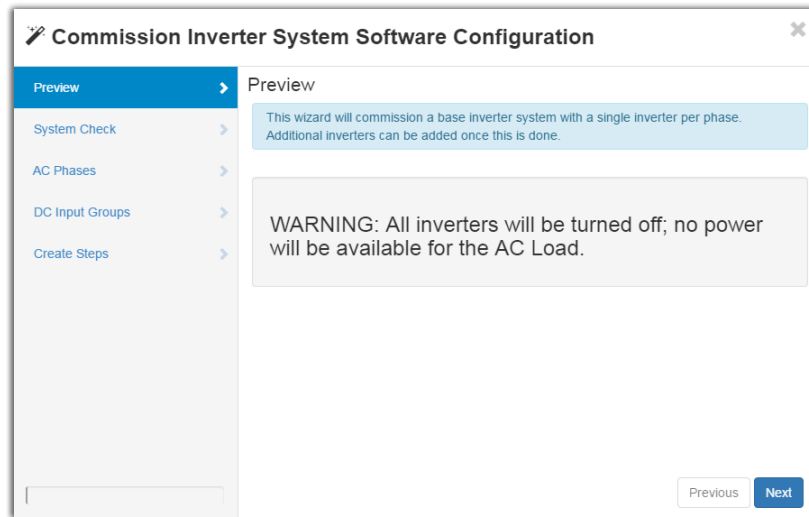
Commissioning may take several minutes to complete. This process is complex due to several factors:

1. The type of AC input source connection is unknown. The AC input source may be connected as single phase, split phase, 2-Pole or three phase. The controller identifies the correct configuration of the AC input and configures the T2S accordingly.
2. For three phase and split phase connection, the AC phase rotation is unknown. This means that if phase 1 is assumed to have a phase angle of 0 degrees, phase 2 may have a phase angle of 120 degrees or 240 degrees. The controller will identify the correct phase rotation.
3. The inverters take time to synchronize to the AC input. As the controller probes all possible combinations the inverters take at least 30 seconds after each combination before determining if they have synchronized to the AC input.

Once the correct AC input connection and the phase angle have been determined, the T2S is configured correctly to accept more inverters.

Adding Inverters

The third stage of commissioning involves inserting the rest of the inverters. This process takes time. It is recommended that you follow all the instructions within the wizard.

When an inverter is inserted, it learns its power configuration from the inverters already inserted in that phase. The controller sets the values for the following:

- AC input group;
- DC input group;
- the location information of bay, and shelf slot ID;
- as well as the correct phase number and phase shift.

After all inverters are inserted into the shelves, the final step is to configure the T2S with the parameters for the number of modules per phase, and the number of redundant modules in each phase. This information is important for the correct operation of alarms associated with redundancy, missing inverters or system overload.

 **Important:** After configuring and commissioning is successful, make a backup of the system from the LCD via the **Shortcuts > Backup** menu. This allows the system configuration to be restored in the event of a CXC HP controller replacement.

7.5. Configure the T2S

There are two procedures for configuring the T2S. These depend on whether the inverter system has a single T2S or four T2Ss. This section covers inverter systems with a single T2S.

 **Note:** For an inverter system with four T2Ss refer to the *Inverters Systems (Four T2S)* chapter to configure the T2S.

For a single T2S system, the configuration of the T2S occurs primarily during the commissioning process. There are two optional settings that an operator may want set after the commissioning is complete: the T2S name and description.

 **Note:** There is a setting called **TUS Mode** in the **T2S Expert Operations** table. This value cannot be changed in a single T2S inverter system and should be left as **No TUS**

Additionally, there are some T2S configuration parameters for the number of modules per phase and the amount of inverter redundancy in a phase that are set during the add and remove wizards. This is why it is required to use these wizards when changing the number of inverters in a system.

To configure a T2S:

1. Go to **System > Inverter System > Inventory > T2S** and click the more details icon of the T2S.

T2S Status			Configuration			Alerts		
Name	Value	Actions	Name	Value	Actions	Name	Value	Actions
Firmware Version	3.8104		Name	Phase 1		Fan Failure (1)	Inactive	
Bay ID	---		Description	---		Temperature Too Low (2)	Inactive	
Shelf ID	---		Target DC Input to Output Power Ratio	0 %		Flash Failure (3)	Inactive	
Slot ID	---		Number Of AC Phases	1		Voltage Reference Error (4)	Inactive	
CAN Communication Status	Normal		Number Of AC Input Groups	1		Internal 15V Auxiliary Power Fail (5)	Inactive	
Alerts	0		Number Of DC Input Groups	1		Internal -15V Auxiliary Power Fail (6)	Inactive	
Serial Number	2239		Phase Angle Phase 1	0 °		In Restart Cycle (7)	Inactive	
Supports ZPS	True		Phase Angle Phase 2	120 °		Output Current High (8)	Inactive	
Refusing Commands	False		Phase Angle Phase 3	240 °		Intermediate Voltage Low (9)	Inactive	
# Communicating Inverters	18		Output Voltage Phase 1	120.0 V		Intermediate Voltage High (10)	Inactive	

2. From the **Configuration** table, enter the **Name** and **Description**.

7.6. Configure the Inverters

The inverters are normally configured automatically when using the commissioning and add inverters wizards. The inverter parameters that are configured automatically are, AC and DC input group, as well as the bay, shelf, and slot ID.

To reconfigure an inverter, remove the inverter first, using use **Remove Inverters** wizard. Add it back into the system using the **Add Inverters** wizard. This ensures that the system configuration remains correct and consistent.

Alternatively, the number of redundant inverters per phase can be changed using the **Configure Inverter Redundancy** wizard. To access the wizard go to, **System > Inverter System > Configure System**.

For expert users it is possible to change the inverters DC Input group and bay, shelf and slot id.

To configure these values manually:

1. Go to **System > Inverter System > Inventory > Inverters > Status** and click the more details icon for the inverter.

Name	Phase	AC In Group	DC In Group	AC Output Power (VA)	Loading (VA)	DC In Current	Active Alerts	IO Status	Actions
TSI/165	0	0	0	0 VA	0%	0.0 A	0	On	Locate
TSI/99	0	0	0	0 VA	0%	0.0 A	0	On	Locate
TSI/113	1	0	0	0 VA	0%	0.0 A	0	On	Locate
TSI/102	1	0	0	0 VA	0%	0.0 A	0	On	Locate
TSI/5207	2	1	1	0 VA	0%	0.0 A	0	On	Locate
TSI/132	2	0	0	0 VA	0%	0.0 A	0	On	Locate
TSI/118	2	0	0	0 VA	0%	0.0 A	0	On	Locate
TSI/2552	3	1	1	0 VA	0%	0.0 A	0	On	Locate
TSI/136	3	0	0	0 VA	0%	0.0 A	0	On	Locate
TSI/119	3	0	0	0 VA	0%	0.0 A	0	On	Locate

2. From the **Inverter Mapping** table, set the **Bay ID** and **Shelf ID** and **Slot ID** to the desired values.

Name	Value	Actions
AC Output Status	On	i
AC Input Status	On	i
DC Input Status	On	i
Phase	0	i
Configured Phase Number	0	i
AC In Group	0	i
DC In Group	0	i
Controller	Master Clock (T2S Inverter Controller/1)	i
Bay ID	---	Click to edit
Shelf ID	---	Click to edit

3. Launch the **Change DC Input Group** wizard and follow the steps.

7.7. Configure the Bypass Switch

The inverter system can have one or more bypass switches. The bypass switch will raise an alarm when the inverter system goes into bypass mode.

If there is more than one bypass switch, then the inverter system will go into bypass mode when any of the bypass switches are activated. During creation of the inverter system a default bypass switch is created. If a physical bypass switch does not exist, the bypass switch should be removed from the system.

To configure the bypass switch:

1. Go to **System > Inverter System > Inventory > Breakers, Fuses and Bypass Switches**. Press the **Add Bypass Switch** button. If the site is equipped with an XMBS bypass switch press the **Add Bypass Switch with XMBS support** button. If a bypass switch exists, but needs to be removed, click the **Remove** button.
2. Click the more details icon of the bypass switch to configure.

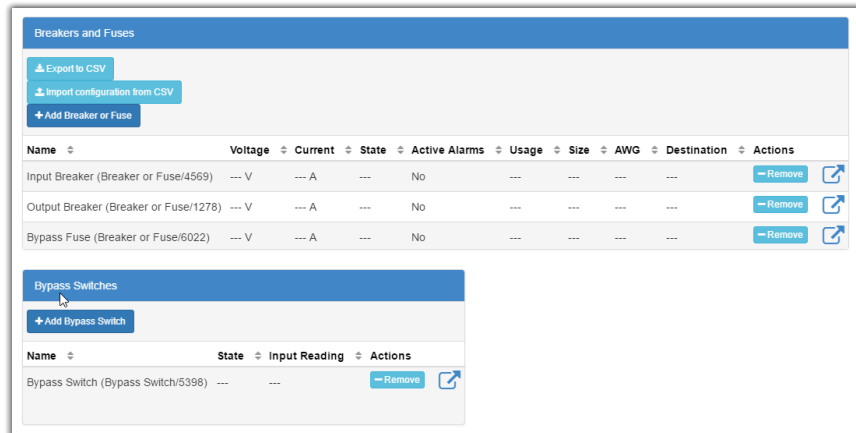

3. In the **Bypass Switch** table, set the **Name**, **Description** and **Input Source** values. When the value of digital input source is **Active**, bypass is in the **Bypass** state. When it is Inactive, the bypass is in the **Inverter** state. Alternatively, click the **Configure Bypass Switch** wizard to be prompted for the essential configuration required for the bypass switch to function.

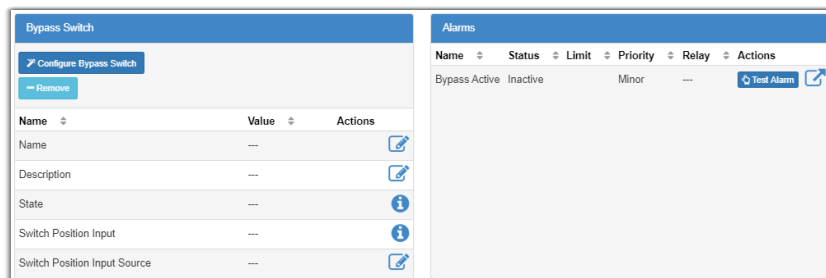

4. Systems equipped with an optional XMBS bypass can configure the signal lines that interface with the bypass switch in the **XMBS Hardware Interface** table. Refer to the manual of the XMBS bypass switch for more information.

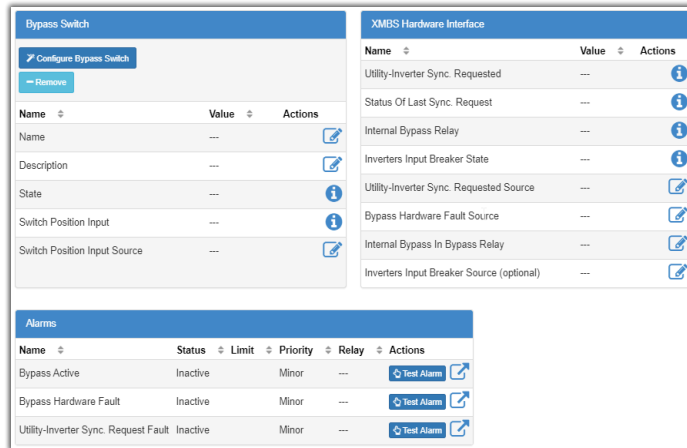

5. In the **Alarms** table, click the more details icon of the **Bypass Active** alarm and configure as required.

7.8. Configure the Breaker or Fuse

The inverter system can have one or more breakers and fuses. An alarm condition occurs when a breaker or fuse is open. When first creating an inverter system, two breakers and a fuse are created by default. They should be removed if not needed.

To configure a breaker/fuse:

1. Go to **System > Inverter System > Inventory > Breakers, Fuses and Bypass Switches**. Press the **Add Breaker or Fuse** button if needed. If a breaker/fuse switch exists, but needs to be removed, in the **Breakers and Fuses** table, click the **Remove** button.

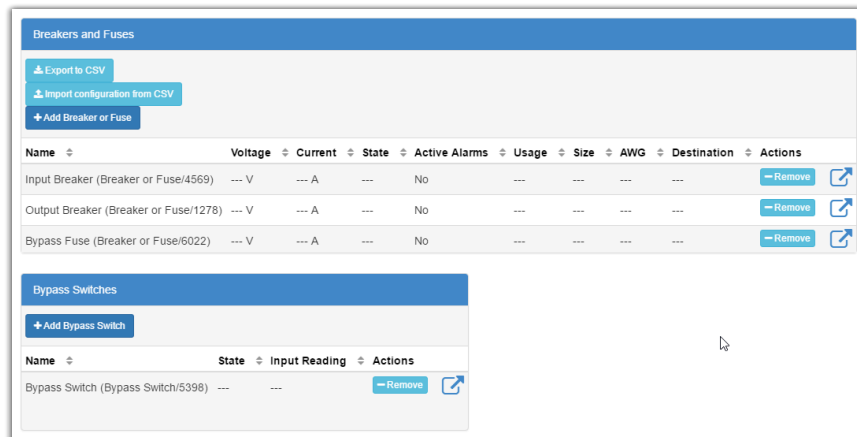

2. Click the more details icon of the breaker or fuse to configure.
3. In the **Configuration** table, enter the **Name**, **Description** and **Input Source** values. When the value of the input source is **Active**, the breaker/fuse is open. Alternatively, click the **Configure Breaker or Fuse** wizard to be prompted for the essential configuration required for the breaker/fuse to function.

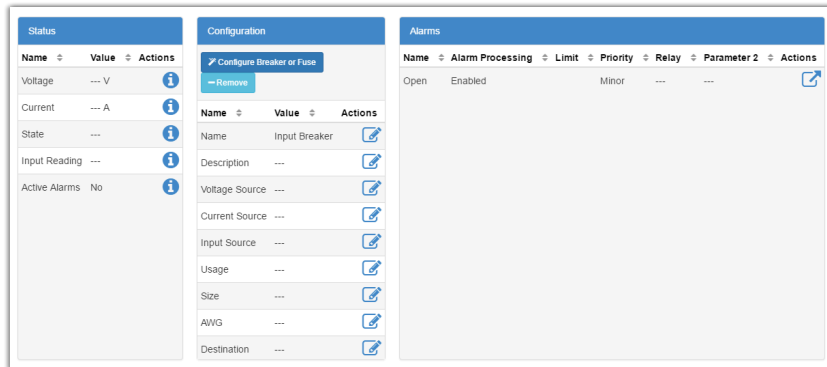

4. In the **Alarms** table, click the more details icon of the **Breaker/Fuse Open** alarm and configure as required.

8. Line Power Systems

This section provides an overview of line power converters, how they function, as well as how to configure a line power system.

8.1. Introduction to Line Power Systems

The power conversion modules (LP modules) in a line power system take a -48V nominal DC input voltage and converts it to a different output voltage. There are three types of LP modules:

- LPS36 \pm 190V
- LPS36 \pm 137V
- eLimiter+ 57V

All three types have four independent output channels, each with a maximum output power of 100W. In a line power system (LPS) the output of the channels from different modules can be combined to supply power to loads at remote locations. Combining channels allows for supplying power to loads that may exceed the 100W limit of a single channel.

The two LPS36 modules are designed for outdoor power applications that deliver power through existing copper telephone wires. The eLimiter+ is designed for indoor power applications that use larger gauge wire for power delivery.

⚠ Warning: Working with LP modules, especially LPS36, pose potentially fatal safety concerns. Refer to the appropriate hardware manual before attempting to wire an LP system or to get more detailed information about the electrical performance of these modules.

8.1.1. Components of a Line Power System

Systems with LPS36 modules are different than systems with eLimiter+ modules.

LPS36 modules require down converters at the remote end to convert the high voltage output to a nominal -48V which is suitable for most loads.

The output of the eLimiter+ modules is already at -48V, so these systems do not require down converters.

Refer to the diagrams below for the typical components of an LPS.

Figure 63. Example LPS36 System

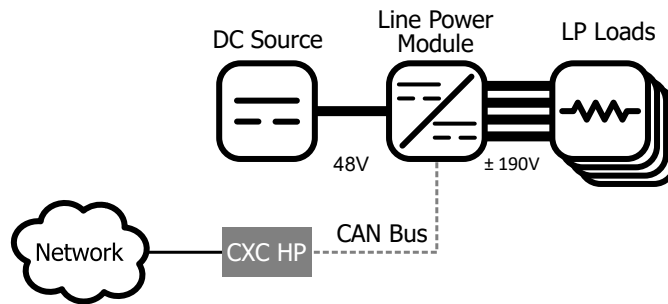
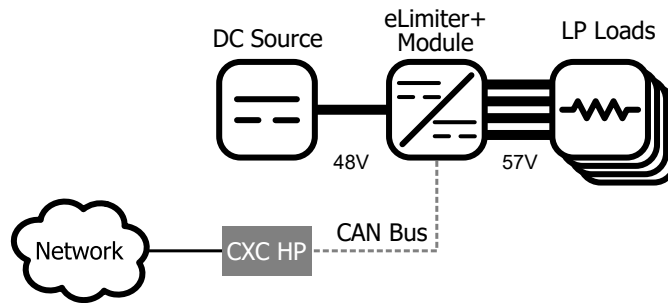

Figure 64. Example eLimiter+ System



Note: Due to the remote location of down converter modules, they are not monitored by the CXC HP controller.

8.1.2. Quick Reference for Configuring a Line Power System

Figure 65. Quick Reference for Configuring a Line Power System

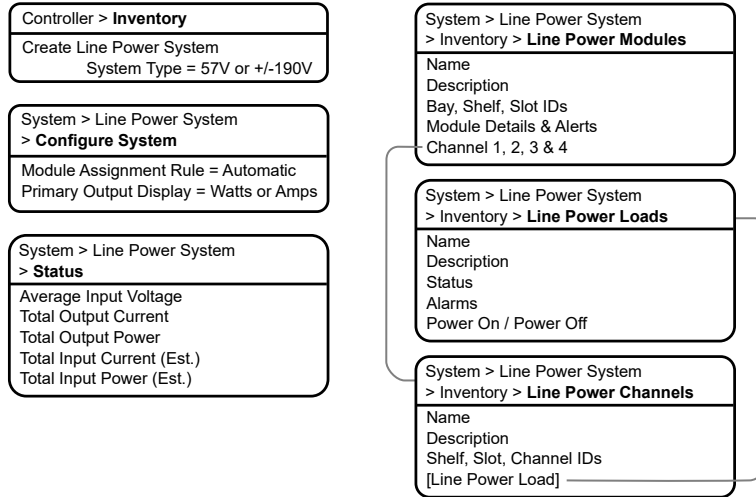

8.2. Creating a Line Power System

There is no line power system on a brand new CXC HP controller. You can create a new system from scratch or import one from a configuration file that contains a system from another controller. It is possible to create more than one line power system.

A new power system can be created from the controller LCD or the web, via the **Controller > Inventory** menu. A wizard steps you through the process to create the new system. You can create three types of systems: LPS36 ±190, LPS36 ±137, or an eLimiter+.

Figure 66. Create Line System Wizard

The new system will have a reasonable set of defaults and associated alarms where possible. Optional configurable values, such as Name, Description, System Number, can be used to describe and organize your system.

The **Module Assignment Rule** setting controls how newly discovered LP modules are treated. The two options are **Manual** and **Automatic**. *Manual* groups all new LP modules into **Unassigned Modules**, and then you can add them to the system manually. *Automatic* adds new, compatible LP modules to the system automatically. This is the default setting.

You can configure the alarms associated with the LP system. You can enable or disable the alarms, change the priority, map relays to the alarms, and where applicable, modify the thresholds.

To create a line power system:

1. Go to **Controller > Inventory**.
2. Click **Create Line System**. Name the system if required.
3. From the **Select System Type** drop-down, select the value that corresponds to your LP module type. If there are LP modules already connected to the controller, they are preselected with the correct option.
4. Follow the rest of the wizard instructions.

8.2.1. Creating a System from a Configuration File

A system can be created by importing from a configuration file. See the “Importing a System” section to do this.

8.3. Configure the Line Power Modules

There are two settings that are applied to all LP modules: **Input Voltage Low Shutdown** and **Input Voltage Low Restart**.

When the input voltage falls below the low shutdown threshold, the LP modules will power off all output channels. Set this threshold to a value that prevents over-discharge of the battery.

When the input voltage rises above the restart threshold, the units turn back on. The restart threshold must be at least two volts above the shutdown threshold or the **LP Module Configuration Error** alarm will activate (LPS36 only).

These settings are stored on the LP module itself which means that even if disconnected from the controller the LP modules will still perform in this way.

To configure the LP modules:

1. Go to **System > Line Power System > Configure System**.
2. From the **Configuration** table, set the **Input Voltage Low Shutdown** threshold to the desired value.

Configuration			System Properties		
Name	Value	Actions	Name	Value	Actions
Name	---		Module Assignment Rule	Automatic	
Description	---		Primary Output Display	Watts	
System Number	---				
System Serial Number	---				
Input Voltage Low Shutdown	42.0 V				
Input Voltage Low Restart	50.0 V	Click to edit			

3. In the same table, set the **Input Voltage Low Restart** threshold to the desired value.

8.3.1. Shared Alarm Configuration

The **Shared Alarm Configuration** feature is a setting which can be used to enable/disable or change the priority of alarms on all LP modules in a system. When using this feature you can configure both the **Channel Shutdown** and the **Module Failure** alarms on the specific LP system being configured. Configuring **Channel Shutdown** will apply the setting to each of the four channel shutdown alarms on each LP module.

8.4. Line Power Module Alarms

LP modules assigned to a system, report active alarms which are displayed on the details page of each specific module, and on the **Active Alarms** page. LP module alarms function the same as regular alarms with the exceptions of shared configuration, as detailed in the previous section.

Each LP module has four channel alarms and a **Module Failure** alarm.

A **Module Failure** indicates a module-level failure such as, input voltage, high/low, high temperature or if the module has lost communication.

A **Channel Shutdown** is activated if any channel shutdown alert such as, over voltage, ground fault, etc. are active.

Both channel and module alarms provide an SNMP notification that identifies the alert/condition which produced the alarm, and the physical location of the module (bay-shelf-slot-channel).

8.5. Configure the Line Power System Channels

Each LP module has four channels that can be given a name, description and assigned to a load. All channels are listed in table that can be sorted and searched. You can also export all channel details to a file.

To configure the channels:

1. Go to **System > Line Power System > Inventory > Line Power Channels**. You will see a table of channels in the system. There is also a **Export Channel Details** button to export the information to a .csv file.

Channels cannot be added or removed. It is also possible to configure channels and get detailed channel information from **System > Line Power System > Inventory > Line Power Modules** and clicking the more details icon for the module.

2. Click the more details icon for the channel you want to configure.
3. In the channel table, assign an optional name and description. This might be a channel address, wire color or customer name.
4. In the channel table, assign an optional **Line Power Load**. To assign a load it is necessary to first create a load. Refer to **Configure the Line Power Loads** to do this.

8.6. Configure the Line Power System Loads

A line power load represents the remote load that is powered by the LP module channels. Create a load when you want to monitor and alarm separate remote loads. Creating a load allows all channels that have been assigned to the load to be powered on or off as a group. To turn all the channels assigned to a load on or off, use the **Power On** or **Power Off** buttons on the **Configuration** table.

You may add or remove loads as needed. Removing a load does not affect the power delivered.

 **Note:** To assign channels to a load, refer to the section on *Line Power System Layout* or *Configure Line Power System Channels*.

To configure the loads:

1. Go to **System > Line Power System > Inventory > Line Power Loads**. You will see a table for loads in the system. This table shows how many channels are assigned to the load and the loads total output current and power. Add or remove loads from this screen.
2. Click the more details icon for the load you want to configure.
3. In the **Configuration** table, assign the load a name and a description. Alpha recommends that you assign the load a name that represents the actual load.
4. Configure the load alarms as needed.

8.7. Line Power System Layout

The line power system **Layout** screen shows a graphical view based on the shelf and slot ID as reported by the line power modules. This view allows a convenient way to view module status and to configure and interact with individual channels.

8.7.1. Using the Layout Screen to View Module Status

The line power **Layout** screen provides a convenient way to view:

- Module shelf and slot position
- Output voltage, power and current for each module
- Module and channel alert status
- Module and channel information (detailed)
- Load information (detailed)

The following steps describe how to use the **Layout** screen to view module and channel status:

1. Go to **System > Line Power System > Layout**. This screen shows a grid of LP modules organized by shelf ID vertically, and slot ID horizontally. Each module is represented by a rectangle showing the output voltage and the output power for each channel. The information in the rectangle is green to indicate that a module is operating normally.

It is possible to display channel output power or channel output current on this screen. Change the **Primary Output Display** to the desired value in the **System Properties** table at **System > Line Power System > Configure System**.

The screenshot shows the 'Bay 1' layout screen. At the top, there are buttons for 'Assign Selected Channel(s) to Selected Load', 'Unassign Selected Channel(s) from Load', and 'Add Line Power Load'. Below these is a 'Line Power Load' dropdown menu set to 'None'. A note says 'Hold CTRL to multi-select'. The main area is a grid with columns for Shelf and Slot 1 through Slot 9. Each cell in the grid contains a channel ID (C1-C4), voltage (V), and power (W). All cells are highlighted in green, indicating normal operation.

Shelf	Slot 1	Slot 2	Slot 3	Slot 4	Slot 5	Slot 6	Slot 7	Slot 8	Slot 9
1	C1 380.0 V 3.4 W	C1 380.1 V 0.0 W	C1 380.0 V 0.0 W	C1 380.0 V 0.0 W	C1 380.2 V 0.0 W	C1 380.0 V 0.0 W	C1 380.3 V 0.0 W	C1 380.1 V 0.0 W	C1 380.0 V 0.0 W
	C2 380.4 V 3.0 W	C2 379.9 V 0.0 W	C2 379.9 V 0.0 W	C2 380.0 V 0.0 W	C2 380.1 V 0.0 W	C2 379.9 V 0.0 W	C2 380.0 V 0.0 W	C2 379.8 V 0.0 W	C2 380.1 V 0.0 W
	C3 380.0 V 0.0 W	C3 380.0 V 0.0 W	C3 380.1 V 0.0 W	C3 380.0 V 0.0 W	C3 380.2 V 0.0 W	C3 380.1 V 0.0 W	C3 380.3 V 0.0 W	C3 380.3 V 0.0 W	C3 379.8 V 0.0 W
	C4 380.1 V 0.0 W	C4 380.0 V 0.0 W	C4 380.1 V 0.0 W	C4 380.1 V 0.0 W	C4 379.9 V 0.0 W	C4 379.9 V 0.0 W	C4 380.4 V 0.0 W	C4 380.0 V 0.0 W	C4 357.8 V 0.0 W

2. Select a channel for detailed information. If a module has an active alert then the green turns to red to indicate an alert with the module or with a channel. If the alert is on a specific channel then the specific channel will be highlighted red. If it is module alert only, then the channels will all show green but there will be red border around the module. To get more detail on the active alert, select the channel that has the alert (if it is a module alert select any channel that belongs to the module). This shows a new table with channel details.

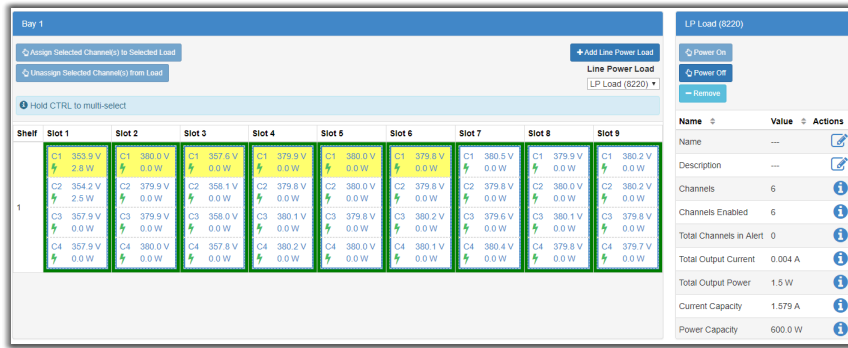

3. In the **Channel Details** table, click the more details icon for the **Line Power Module** to view active alert information.
4. In the **Module Alerts** table sort by **Value** to bring the active alerts to the top of the table.

8.7.2. Using the Layout Screen to View Load Status

The following steps describe how to use the **Layout** screen to view load status.

1. Go to **System > Line Power System > Layout**.

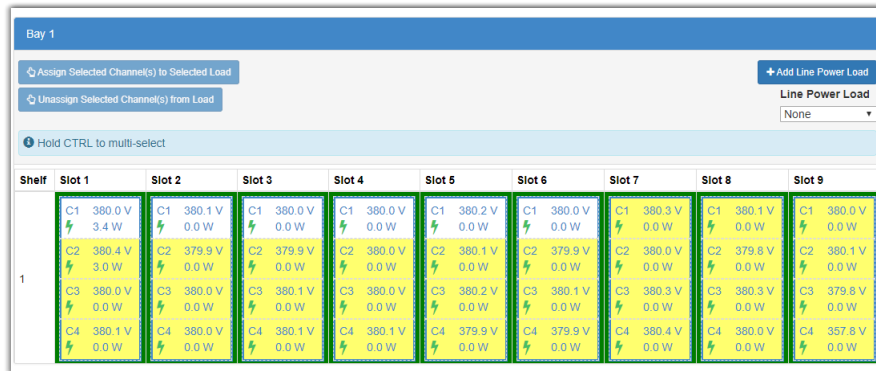

2. Using the **Line Power Load** drop-down list, select a load. A table displays detailed information about the load. You can modify the name, description, and other information about the load as well as do all load management tasks from this page.

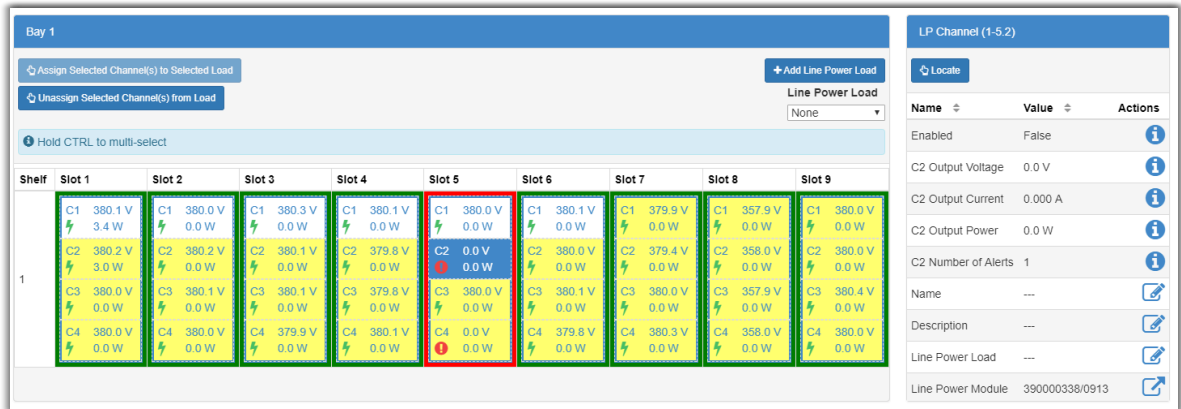

8.7.3. Using the Layout Screen to Assign Channels to Loads

The line power **Layout** screen provides a convenient way to:

- View which channels have been assigned to the LP Loads
- Assign channels to an LP Load
- Unassign channels from Loads
- Add, remove, and rename Loads

To use the **Layout** screen to view and configure channels assigned to LP Loads:

1. Go to **System > Line Power System > Layout**. At the top of the table use the drop-down menu to select an LP load. When **None** is selected, the channels that are not assigned to a load display as highlighted.

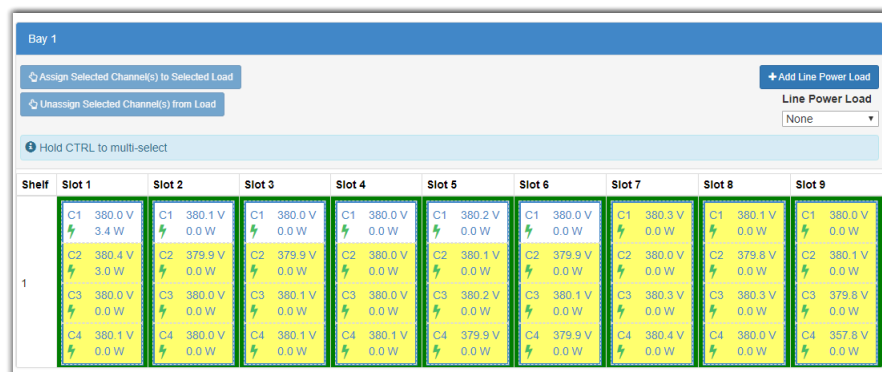

2. Select a load from the drop-down menu. The channels assigned to this load will be highlighted.

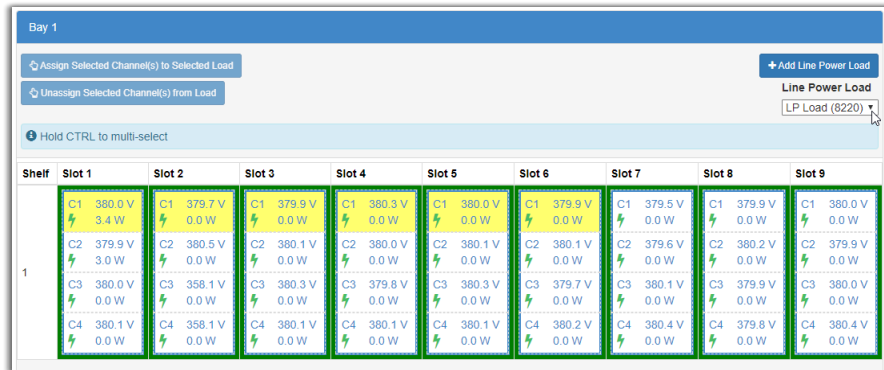

3. To add a new channel to the load, select it. The channel rectangle will turn blue to indicate it is selected.

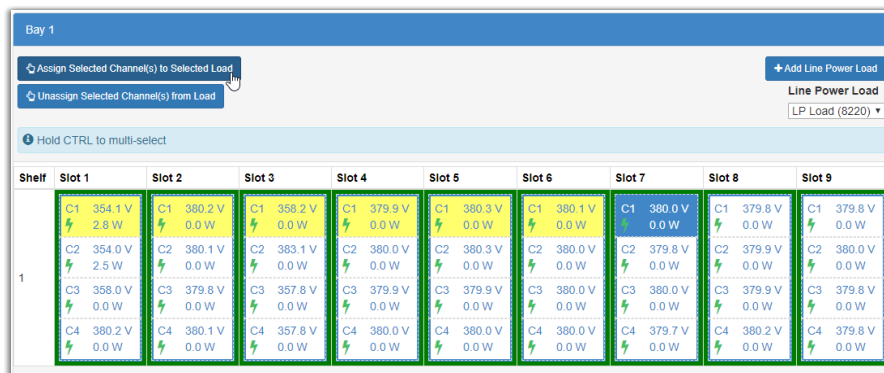

4. In the layout table, click **Assign Selected Channel(s) to Selected Load**. In the channel details table, the **Line Power Load** field will be populated with the name of the load.

By default, the **Assign Selected Channel(s) to Selected Load** and **Unassign Selected Channel(s) from Load** buttons are disabled unless a load and channel(s) are selected.

5. To unassign a channel from the load, click a highlighted channel, and then click **Unassign Selected Channel(s) from Load**. In the channel details table, the **Line Power Load** field will be set to "--"

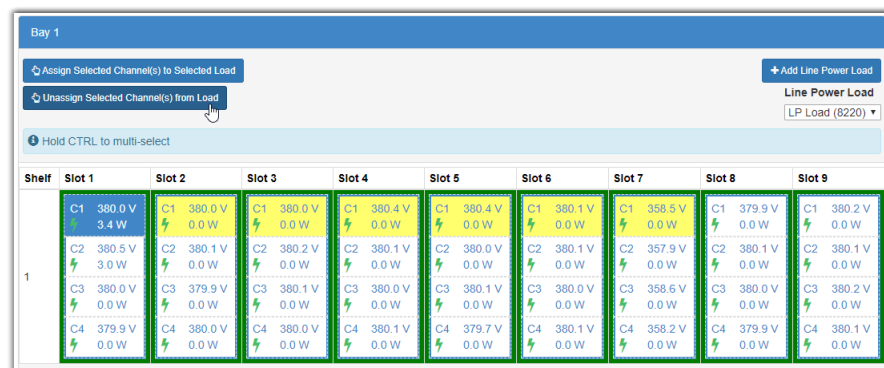

6. To assign or unassign multiple channels at once, hold **CTRL** on the keyboard and click the required channels which display as blue when selected.
7. Once all required channels are selected, use the **Assign Selected Channel(s) to Selected Load** or **Unassign Selected Channel(s) from Load** buttons to assign and unassign multiple channels.

9. Auxiliary Systems

This section provides an overview of the auxiliary system and how it is configured.

9.1. Introduction to Auxiliary Systems

The auxiliary system serves as a standalone system for monitoring the readings on a current or other transducer. Both AC or DC current transducers can be used.

The typical application for this type of system is to monitor current flowing through the AC feeds into a site or a power system.

When current transducers have been added to the system they display in the controller dashboard of the LCD, and the **Auxiliary System** dashboard of the web interface. The auxiliary system does not presently have any key status information for display on the LCD dashboard or in the system's summary region on the top of the main dashboard page on the web.

9.2. Create an Auxiliary System

To create an auxiliary system:

1. Go to **Controller > Inventory** and click the **Create Auxiliary System** button.
2. Go to **System > Auxiliary System > Configure System** and enter a **Name** and **Description** for the system.

9.2.1. Creating a System from a Configuration File

A system can be created by importing from a configuration file. See the "Importing a System" section to do this.

9.3. Current Transducers

The physical current transducer can be of the voltage-output type (0-5V or 0-10V) or current-output type (4-20mA) type depending on the accuracy requirements. A 4-20mA type is more accurate because losses in the sensor leads are inherently compensated.

A transducer with a voltage output can be connected directly to an L-ADIO voltage input. A transducer with 4-20mA output must have a 500R resistor added across the voltage input. For AC, the current transducer must be of the type which conditions the signal to provide a DC output proportional to the RMS (or average) value. AC waveforms cannot be monitored by the LADIO input circuitry due to noise filtering.

9.4. Configure the Current Transducer

The system, by default does not contain any current transducers. You can add or remove current transducers as needed. To configure a current transducer you need a voltage input on an ADIO. To configure a current transducer with an IPM, you need a shunt input on an ADIO.

To configure a current transducer:

1. Go to the system where you want to add the transducer and navigate to the inventory page. Go to, **System > Inventory > Other Transducers > Current Transducer**. There will be a list of current transducers in the system. Add or remove them from this page.

You may be using a current transducer with **Interface & Power Module (IPM)**. This device takes the voltage reading from a current transducer and divides the reading by 50. The factored voltage reading is then sent to the L-ADIO Shunt Input.

2. Click the more details icon for the **Current Transducer** you wish to configure.
3. In the **Configuration** table, click on **Configure Current Transducer** to enter the configuration wizard and complete the details.
4. Enter the **Measurement Range** in amps.
5. Enter the **Range in Volts**.
6. Select the **CT Current Source**. This can be any voltage source.
7. Optional: enter the **Offset** calibration for the **Current Transducer** if the reading error is too low or too high.

9.5. Configure the General Purpose Transducer

The system, by default does not contain any general purpose transducers. You can add or remove general purpose transducers as needed. To configure a general purpose transducer you need a voltage input on an ADIO.

To configure a general purpose transducer:

1. Go to the system where you want to add the transducer and navigate to the inventory page. Go to, **System > Inventory > Other Transducers > General Purpose Transducer**. There will be a list of general purpose transducers in the system. Add or remove them from this page.
2. Click the more details icon for the **General Purpose Transducer** you want to configure.
3. In the **Configuration** table, enter the **Configure General Purpose Transducer** wizard and complete the details, otherwise follow steps 4-9.
4. In the **Configuration** table assign a name and a description.
5. Select the **Transducer Input Source**. This can be any voltage source or a custom data.
6. Enter the **Transducer Input Minimum in Volts** and **Transducer Input Maximum in Volts**.
7. Enter the **Transducer Output Minimum** and **Transducer Output Maximum**.
8. Select the **Units and Precision**
9. Optional: enter the **Offset** calibration for the calculated **Value** if the reading error is too low or too high.

The **Calculated Slope** and the **Offset** are used to convert the **Input Source Value** to the **Value**. The value is displayed in the selected units and precision.

10. Distribution Systems

This section provides an overview of the operation and configuration of a distribution system and its subsystems, panels and breakers.

10.1. Introduction to Distribution Systems

A distribution system is a way to define and track how the output power of a DC system is distributed. The system may be composed of specialized ADIOs built for the purpose of distribution or via general-purpose ADIOs in any configuration. The distribution system itself is really just a “container” to hold distribution subsystems.

In the case of the specialized ADIOs (a smart subsystem), the subsystem will map one-to-one with the ADIO. For example, a Smart BDFB ADIO module will be represented in the distribution system as one subsystem. Manually created subsystems can be mapped to a number of ADIOs, and contain a user-defined number of breaker/fuse panels and breakers themselves.

Within a subsystem there are a number of panels. A panel is a grouping of breakers/fuses.

A panel is considered a ‘downstream load’ of a subsystem and a breaker/fuse is considered a ‘downstream load’ of a panel. A breaker can then feed a referenced load. For example, a breaker may feed a DC system or another subsystem. In this way, a user can create primary and secondary distribution layouts. Understanding this relationship helps to visualize how a distribution system, its subsystems, panels, breakers/fuses and referenced loads are organized.

A manually defined subsystem may contain up to 160 breakers across all panels. This could consist of 160 panels with one breaker each, 10 panels with 16 breakers each, or another combination. The smart subsystems will contain the number of panels and breakers supported by the ADIO type to which they correspond.

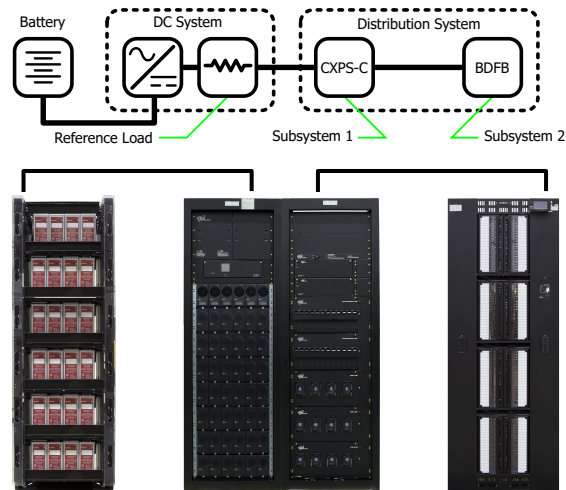
Figure 67. Example of a DC System Distribution System

10.2. Creating a Distribution System

There is no distribution systems on a brand new CXC HP controller. Creating distribution systems is done via the **Create Distribution System** button located under the **Controller > Inventory** menu. There is no configuration required at the system level.

You can also import a distribution system via a configuration file.

The CXC HP supports multiple distribution systems. Alpha recommends the use of multiple distribution systems to separate the distribution of different voltage levels. For example, a user can create a 48V Distribution System, and a 24V Distribution System. The multiple systems could also be used in different ways, such as to separate primary and secondary distribution, or even physical layouts such as “first floor distribution” and “second floor distribution”.

When first created, a distribution system is empty. Subsystems must be added to give the system meaning. The system-wide voltage and current readings are **Unknown** when the subsystem is first created. These values are mapped to sources via the **System > Distribution System > Configure System** page. By default, the **Voltage Source** is set to **Average All External Input Voltages** and the **Current Source** is set to **Sum All External Input Currents**.

External inputs, as mentioned above, mean inputs external to the Distribution System. Only subsystems that are mapped as a referenced load in another system will be used to create system summary values by default. This provides the opportunity to nest layers of subsystems within the same distribution system, and have the system summary values computed properly. If a different behavior is required, the voltage and current sources can be edited to sum or average all subsystems, or to point to any other voltage and current sources available on the controller, including Custom Data.

To create a distribution system:

1. Go to **Controller > Inventory** and click the **Create Distribution System** button.

2. A system is immediately added to the **Inventory** table.
3. Go to **System > Distribution System > Configure System** and enter a **Name**, **Description** and any other identifying information required.

10.2.1. Creating a System from a Configuration File

A system can be created by importing from a configuration file. See the “Importing a System” section to do this.

10.3. Distribution Subsystems

Once a distribution system exists, at least one subsystem must be added. This is done via the **System > Distribution System > Subsystems** menu on the web or LCD. There are two types of subsystems: **Smart Distribution Subsystem** or **User Defined Subsystem**. Each type uses a wizard to assist in creating and configuring a subsystem.

Generally a subsystem will correspond to a physical rack on the site. Subsystems that distribute power from the same source should all be contained within the same distribution system. Multiple distribution systems are possible, but should only be used if the representation of multiple distributions systems is required.

For example, distribution equipment such as on different two different floors, may be better represented by two distributions system rather than one.

The following sections describe the different subsystems and information on creating them.

10.4. Create a Smart Subsystem

A smart subsystem correlates one-to-one with a “smart” distribution ADIO, such as the Smart BDFB or the Smart E2. The number of panels and breakers supported by that ADIO are created automatically. During the wizard set up, you can map the ADIO for the subsystem. This can also be done later if the ADIO is not available when the system is created. The smart subsystem will not function properly until the correct type of ADIO is assigned.

In the first step of the wizard, there is an option to name the subsystem. The current smart subsystems are the Smart BDFB or the Smart E2. From the list of ADIOs currently acquired by the controller, you can choose the ADIO for this subsystem, or it can be done later via the **System > Distribution System > Subsystem > ADIO** page. Once an ADIO is selected, you can choose to “locate” the ADIO to ensure it is correct. It is also possible to give a custom name to the ADIO so that it is easily recognized in the **Modules > All Modules** list.

In a smart subsystem, inventory is automatically created based on the system type. For example, a Smart BDFB supports eight panels with 20 breakers per panel, and a Smart E2 has two panels with 11 breakers. The ADIO inputs to panels and breakers are also mapped automatically.

A smart subsystem gets all available information from its associated ADIO. For each panel, the current and voltage are measured by the ADIO, as well as any active alarms. On the Smart BDFB, one breaker trip signal is available per panel. This means that the subsystem knows, at the panel level, that one or more of the 20 breakers associated with that panel are tripped, but not which particular breakers. On the

Smart E2, the individual breaker trip signals are provided by the ADIO, so they can be displayed at the breaker level.

The Smart BDFB also has the ability to have its panels set up as “linked” to other panels, or “blank” if unused. This information can be viewed from the **System > Distribution System > Subsystem > Panel** page.

The Smart E2 has a temperature alert, which other ADIO types do not. There is a field called **Over Temperature Alert** in the subsystem, which is only populated for E2-based subsystems.

Figure 68. Example of BDFB Distribution Subsystem

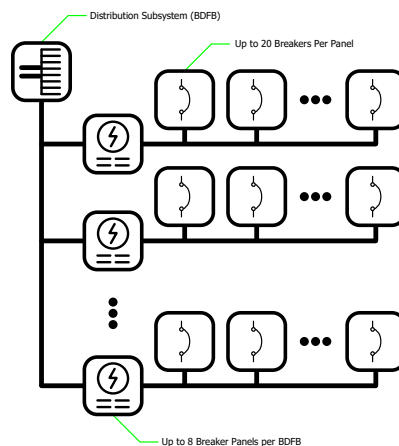

To create a smart distribution subsystem:

1. Go to **System > Distribution System > Subsystems**, and then click **Create Smart Distribution Subsystem**. Follow the wizard.

You can now view the **Smart Distribution Subsystem** from the **Distribution Subsystems** table. No further configuration is necessary. If you plan to reconfigure the smart ADIO, continue below.

2. Go to the **System > Distribution System > Subsystem > ADIO** menu.
3. Click the details icon of the assigned ADIO to view all its details including configuration and I/O. (Ensure there is an ADIO assigned to the system first.)
4. In the **Configuration File** table use the **Upload Configuration file to Controller** and **Get Configuration File from ADIO** buttons to send the configuration to the ADIO.

10.5. Create a User Defined Subsystem

Any type of distribution that is not a smart subsystem is called a user defined subsystem. The user can specify the number of panels, breakers/fuses and shunts, and then quickly bulk-map the ADIO inputs to shunt sources.

The first step of the wizard there is an option to name the subsystem. Next, specify the number of breaker/fuse panels to create. There is a limit of 160 breakers across all the panels. This could consist of 160 panels with one breaker each, 10 panels with 16 breakers each, or some other combination. There is an option to name each panel, specify the number of breakers/fuses, and specify the shunt configuration. When finished you can still add/remove panels, breakers and shunts via their respective pages in the subsystem tree. After panels, breakers and shunts have been added, specify the ranges of all the shunts in the subsystem. These can be changed later via the **Shunts** table.

Figure 69. Example of a User Defined Subsystem

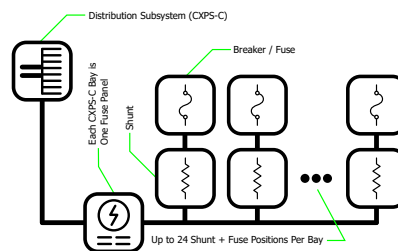

To create a user defined subsystem:

1. Go to **System > Distribution System > Subsystems**, click **Create User Defined Subsystem**, and then follow the wizard.
2. In the **Distribution Subsystems** table, click the more details button to view the subsystem.
3. If you need to map the shunt sources, go to **System > Distribution System > Subsystems > Subsystem > Shunts**, click **Assign Dedicated ADIOs as Shunt Inputs**, and then follow the wizard.

10.6. Configure the Panel Details

A panel is a grouping of breakers and/or fuses within a subsystem. A panel is considered a downstream load of a subsystem. On smart subsystems, these are automatically created according to the number of panels that the ADIO supports. For BDFB subsystems, the full eight panels are created, even though some may be linked or blank. For E2 subsystems, two panels are created. On a user defined subsystem, you can add up to 10 panels per subsystem.

To monitor a breaker or fuse trip associated with a panel, the **Breaker/Fuse Source** should be mapped to a digital input as well. Again, for smart subsystems, these values are automatically set based on the assigned ADIO.

There are several text fields associated with a panel, which the user may find useful to further describe the panel, such as Description, Fuse Number, Fuse Size, and Fuse Maximum Amperage. These are optional and may be filled in by the user if desired.

There are three alarms provided on each panel: **Breaker Trip**, **Loss of Feed**, and **Over Current**. On a user defined subsystem, thresholds for these alarms are set as applicable. The **Breaker Trip** alarm is not a threshold alarm; it is calculated based on the **Breaker/Fuse Source** set for the panel. On a smart subsystem, alarms come directly from the ADIO and thresholds must be set on the ADIO.

A concept specific to the BDFB is linking panels. Panels may be linked up to the panel above, or linked down to the panel below, based on the loads. They may also be set blank if unused. When one or more panels are linked, one must still be designated as the “shunt”, and the others are configured as linked. The voltage and current measurements are taken from the shunt panel only. The breaker trips are still monitored on all linked panels. The configuration of panels as shunt, linked up, linked down, or blank must be done via the BDFB ADIO. The CXC HP controller only reports the details.

To configure panel details:

1. Go to **System > Distribution System > Subsystems**, and click the details icon for the subsystem that contains the panels to configure.
2. Enter the **Subsystem Details** menu.
3. In the **Downstream Loads** table, click the details icon for the panel to configure.
Note that in smart subsystems, the configuration is done automatically via ADIO.
4. In the **Configuration** table, edit the details of the panel.

10.7. Configure the Breaker/Fuse Details

In a distribution system, a breaker/fuse represents a downstream load of a panel. Breaker/fuse configuration can be accessed directly under the subsystem, or from the panel in which it resides.

Within the Breaker/Fuse configuration, there are a number of text fields that can be used to better describe and define the breakers. These cannot be obtained from the ADIO in any automatic way. They need to be configured manually. These fields include a **Description**, **Usage**, **Size**, **AWG**, and **Destination** field for each breaker. Manually editing all of these fields is a lot of work for large systems. The most effective way to do this is to download and edit the fields in spreadsheet format. This makes it easy to cut and paste, use macros, or reuse entered text for other purposes (such as printing labels).

 **Note:** *The input source of the breaker is set automatically because the value is constrained by physical wiring on the panel. Although the field is editable, it will be set back to the correct value if it is manually changed. This is true for E2 subsystems only.*

To configure all breakers/fuses in a distribution subsystem:

1. Go to **System > Distribution System > Subsystems** and click the details icon for the subsystem that contains the breakers/fuses to configure.
2. Enter the **Breakers and Fuses** menu.
3. Click **Export to CSV** to download a file to the computer. Open this file in a spreadsheet program.
Alternatively, you can export a CSV file to configure just the breakers/fuses associated with a single panel. Go to **Subsystem > Subsystem Details > Downstream Loads**, and then click the details icon of the **Panel** that contains the breakers/fuses configuration you want to change. In the **Downstream Loads** table, click **Export to CSV**.
4. In the spreadsheet program, enter the breaker/fuse information as needed. Ensure that you do not to change the Owner or Identity column. This is required to import the configuration correctly. Save the file.

5. Press the **Import Configuration from CSV** button and select the edited file.
6. Once uploaded, verify the configuration is correct.

10.8. The Subsystem Layout

Distribution subsystems contain a **Layout** page to visualize the layout of the panels. This page shows the panels, including a graphical representation of whether the panels are linked (in Smart BDFB).

- In smart subsystems, panels are arranged two panels per row, to best match the LCD screens of the smart devices.
- In user defined subsystems, panels are arranged one per row to more closely represent a physical distribution system.

Clicking a panel will display the details on the right side of the layout page, as well as a table for breakers, and for shunts (user defined subsystem only). This is available via the web only.

To view the **Layout** page, go to **System > Distribution System > Subsystems**, then click the details icon of the subsystem required. Click to enter the **Layout** menu.

Figure 70. Distribution Subsystem Layout

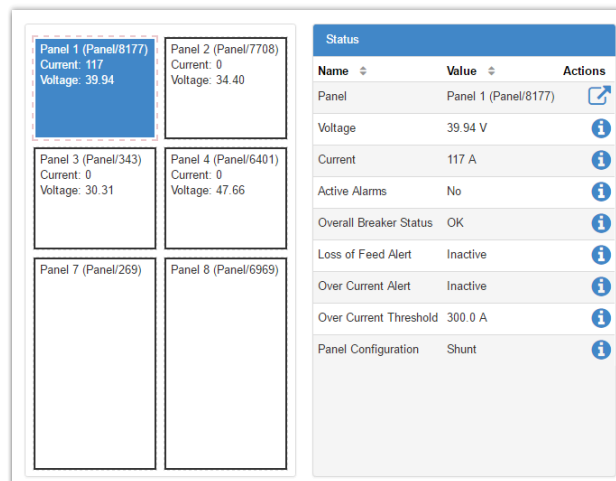

10.9. Map Shunts to ADIO Inputs

The **Map Shunts to ADIO Inputs** wizard assists the process of mapping ADIO shunt inputs to shunt inventory items. Alpha recommends that your ADIOs are named before launching this wizard to help identify which ADIOs to select.

Using the wizard you can select to map in bulk or individually. In bulk mode, the current sources of the shunt inventory in the subsystem are set automatically to the shunt inputs of the ADIOs selected in the

wizard; the ADIOs will be mapped in the order in which they were selected in the wizard. In individual mode, you can select an ADIO shunt input for each Shunt.

Within the distribution system, this wizard is only available for user defined subsystems. You can launch this wizard from any of the tables in subsystems that show shunts. The following example shows how to configure a subsystem for a CXPS-C.

To create a CXPS-C distribution subsystem:

1. Follow the steps detailed in the **Creating a User Defined Subsystem** section, creating six panels, with four breakers per panel, and one shunt per breaker.
2. Ensure that four 6I ADIOs are acquired and named as per the schematic (#1-#4).
3. Go to **System > Distribution System > Subsystems > Subsystem > Shunts**, and click **Map Shunts to ADIO Inputs**.
4. On the **Shunt Mapping Type** step, ensure the mapping type is selected as **Map Shunts in Bulk** and click **Next**.
5. Leave the first panel selected in the **Select Starting Panel** step, and click **Next**.
6. On the **ADIO To Shunt Configuration** step, set the ADIO Configuration as **ADIOs Wired Sequentially** and click **Next**.
7. Select ADIO #1 from the drop-down, and then click **Add Selected ADIO to List**. You will see the list below update with the ADIO you just selected.
8. Repeat for ADIOs #2 - #4, and then click **Next**.
9. The **Review** step details which inputs are mapped to which shunts. Review to ensure it matches the wiring schematic.
10. Click **Next**, and the 24 inputs of the four 6I ADIOs will now be mapped to the 24 shunts in the user defined subsystem.

11. DC Source Systems

This section provides a brief overview of the components and functions of a DC Source System. In this system, DC Sources external to the controller (PV cells or DC generators), can be created and monitored.

11.1. Creating a DC Source System

There is no DC Source system on a brand new CXC HP controller. Creating a DC Source system is done via using **Create System** wizard. There is no configuration required at the system level.

You can also import a DC Source system via a configuration file.

The CXC HP supports multiple DC Source systems. It is recommended to use multiple DC Source systems to separate different types of DC Sources contributing to the DC bus. For example, a user can create a PV DC Source System, and a Generator DC Source System. This is optional, and a users can group DC Sources together however makes the most sense for their specific use case.

When first created, a DC Source system is empty. DC Sources must be added to give the system meaning. The system-wide voltage and current readings are **Unknown** when the system is first created. These values will be the average of all DC Source voltages, and the sum of all DC Source currents.

To create a DC Source system:

1. Go to **Controller > Inventory** and click the **Create System** button to launch the **Create System** wizard.
2. From the drop-down menu, select **DC Source System**, then click **Done**.
3. A DC system is added to the **Inventory** table.
4. Go to **System > DC Source System > Status & Config** and enter a **Name**, **Description** and any other identifying information required.

11.2. Create and Configure a DC Source

A **DC Source** will represent one single piece of inventory which is external to the controller, providing DC power to the bus. For example, a DC Source could be a PV array.

A special type of DC Source is provided to model a DC Generator. This DC Source has additional capabilities for controlling a generator using a relay to start and stop it, based on a voltage or a set of optional conditions.

To create and configure a DC Source:

1. Go to **System > DC Source System > DC Sources**.
2. In the **DC Sources** table, select one of two types of DC sources.
 - A generic **DC Source**.
 - A **DC Generator** is a specialized type of DC Source that can be controlled through use of a relay.
3. After the DC Source has been added, click on the more details icon.

4. In the **Configuration** table, set the **Name** and **Description** to identify the **DC Source**.
5. In the **Configuration** table, set the **Voltage Source** to the ADIO voltage sensor reading that is monitoring the voltage of this DC Source. Do the same for **Breaker/Fuse Source** (if applicable).
6. In the **Configuration** table, set the **Current Source** to the configured **Shunt** that is monitoring the current of this DC Source.

 **Note:** A **Shunt** needs to be created and configured before the **Current Source** of this DC Source can be configured.

11.3. DC Generator

A **DC Generator** is a specialized type of DC Source which allows a generator to be started and stopped with a relay.

The standard condition on which to start or stop a generator is based on a voltage. The controller allows the user to choose any voltage in the system and set it as the **Voltage to Monitor**, with a start threshold and a stop threshold. The generator will be started if the **Voltage to Monitor** falls below the **Start Voltage Threshold**, and will be stopped if the **Voltage to Monitor** climbs above the **Stop Voltage Threshold**.

The optional start or stop conditions can be used to start and stop the generator based on other types of conditions. For example, the battery State of Charge could be used. The ability to use Custom Data or other system values gives the generator control a lot of flexibility; however, care must be taken to ensure that the start and stop conditions make sense. Otherwise, it is possible for the user to create, for example, a start condition that is always true, in which case the generator would not stop running.

The Minimum Runtime assures that the generator will not be started to only run for too short a period of time. Once the generator has started, it will continue to run for the Minimum Runtime even if a stop condition has become true.

The Maximum Runtime is intended to ensure that the generator does not continue to run indefinitely even if no stop condition comes true. After running for the Maximum Runtime, the generator will attempt to shut down. It should be noted that if a start condition is still true, it would start up again immediately. In that case, an event message will be logged. Additionally, there is a **Generator Running Too Long** alarm that may be enabled to help alert the user to this situation.

11.3.1. Create and Configure a DC Generator

To configure a DC Generator:

1. Go to **System > DC Source System > DC Sources**.
2. In the **DC Sources** table, click **Add DC Generator**.
3. After the DC Generator has been added, click on the more details icon.
4. In the **Generator Control** table, click the **Configure Generator Control** button to run the configuration wizard.
5. In the **Generator Control** dropdown menu choose from the following:
 - **Enabled** Chose enabled if the generator can be controlled by a relay.
 - **Disabled** If disabled is chosen no further configuration is required.

6. Under **Generator Control Signals** select the **Generator Control Relay** and the **Generator Status Signal Source**. Click **Next**.

 **Note:** The **Generator Control Relay** is mandatory as it is the relay that will be used to start and stop the generator.

 **Note:** The **Generator Status Signal Source** is optional, but it should be mapped to a digital input which can be used to monitor whether or not the generator is running.

7. Under **Voltage to Monitor**, choose a voltage signal to be monitored.
 - a. Enter a **Start Voltage Threshold**.
 - b. Enter a **Stop Voltage Threshold**.
 - c. Click **Next**.
8. Review your settings and click **Next**.

Additionally, the alarms for **Generator Control** may be configured. The **Generator Status Mismatch** alarm will be active if there is a **Generator Status Signal Source** configured, and the status does not match what is expected. For example, if the **Generator Command Status** indicates that the generator should be running, but the **Generator Status Signal Source** indicates that it is not (as reported in the **Generator Running** status field), the **Generator Status Mismatch** alarm will become active. Similarly, if the **Generator Command Status** indicates that the generator should not be running, but the signal indicates that it is, the alarm will activate. The **Generator Running Too Long** alarm is disabled by default. If enabled, it will indicate if the generator has run past the **Maximum Runtime** due to a start condition that is still true.

11.4. DC Source System Effect on Other Systems

A DC Source System is useful in representing external equipment for inventory purposes. Its strength lies in making DC System calculations more accurate. Many DC systems will use a battery shunt to read the battery current, and the load current will be calculated using $= (\text{Total Output Current} - \text{Battery Current})$.

In situations where there are DC Sources external to the controller, this calculation would not be sufficient.

When DC Source Systems are created, two new calculations are available:

- $= (\text{Total Output Current} - \text{Battery Current} + \text{Total DC Source Current})$
- $= (\text{Total Output Current} - \text{Total Load Current} + \text{Total DC Source Current})$

These can be used when a DC Source is present to ensure the contributions of the DC Sources to the system currents will be accurate. In the case that both load and battery use shunts to measure current, a Custom Data can be used to include the contributions from the DC sources.

In addition to the above, DC Source Systems will appear on the Power Flow in the relevant diagrams, giving a more complete picture of all the power sources flowing through the system.

12. AC Source Systems

This section provides a brief overview of the components and functions of an AC Source System. AC Source Systems are intended to be used by customers who need to model multiple AC Sources for their system. An example might be a system that has a set of rectifiers fed from AC mains, and a different set fed from a generator. For customers with a single AC Source, or even multiple sources such as mains and generator which switch over automatically with a transfer switch, it is usually not necessary to model an AC Source system.

12.1. Creating an AC Source System

There is no AC Source system on a brand new CXC HP controller. Creating an AC Source system is done using the **Create System** wizard. There is no configuration required at the system level.

You can also import a AC Source system via a configuration file.

The CXC HP supports multiple AC Source systems. Multiple AC Sources can be modeled within the same AC Source System. Users can group AC Sources together to best suit their specific use case.

When first created, an AC Source system is empty. AC Sources must be added to give the system meaning. The system-wide voltage readings are **Unknown** when the system is first created. These values will be the average of all AC Source voltages for each phase.

To create an AC Source system:

1. Go to **Controller > Inventory** and click the **Create System** button to launch the **Create System** wizard.
2. From the drop-down, select **AC Source System**, then click **Done**.
3. An AC system is added to the **Inventory** table.
4. Go to **System > AC Source System > Status & Config** and enter a **Name**, **Description** and any other identifying information required.

12.2. Create an AC Source

An **AC Source** will represent one AC input to the system, for example AC Mains.

To create and configure an AC Source:

1. Go to **System > AC Source System > Inventory**.
2. In the **AC Sources** table, click **Add AC Source**. The **Add AC Source** wizard will launch.
3. Set the **Name** to identify the **AC Source**.
4. Select one of two types of AC Sources.
 - A **Simple AC Source** can be used to model an AC Source with voltage readings for each phase. This source includes **AC Fail** and **Urgent AC Fail** alarms.
 - A **Generator** is a specialized type of AC Source which allows the use of a relay to start and stop a generator based on a set of conditions to be configured later.

5. Select the **Phase** for your **AC Source**.
6. On the **Alarms** page, select whether the AC Input Fail alarm should be enabled for this source. Select **Yes** or **No**.
7. On the **Voltage Readings** page, select the system from which the AC Source will obtain its readings.
8. If a DC System was chosen for the **Voltage Readings** source in step 7, there will be an option to run the separate **Map Rectifiers to AC Source** wizard on the **Results** page.

 **Note:** *If the **Voltage Reading Source System** has been set to a DC System, the phase voltage sources will be automatically set to the mapped rectifiers. If the **Voltage Reading Source System** has been set to an Inverter system, these phase voltage sources will be set to read from the Inverter system. If the **Voltage Reading Source System** is left unknown, these phase voltage sources should be set to read from transducers or any other voltage sources as desired.*

 **Note:**

*If the **Voltage Reading Source System** has been set to a DC System, and the AC Fail alarms are enabled, the AC Input Fail alarm will be calculated in the same manner as the DC System's AC Fail alarm. If 90% of the rectifiers mapped to this AC Source have failed, then the AC Input is assumed to be failed. Otherwise, if the **Voltage Reading Source System** is set to an Inverter system, or left unset, the AC Input Fail alarm will be activated if any one of the phase voltages falls below 10V.*

12.2.1. Map Rectifiers to an AC Source

An **AC Source** can get its data from either a DC System, an Inverter System, or from Transducers.

To map rectifiers from a DC System to an AC Source:

1. Run the **Map Rectifiers to AC Source** wizard. This can either be run directly from the results page of the **Add AC Source** wizard, or launched from **System > AC Source System > Inventory > AC Source** page.
2. Choose rectifiers to map from the **Selected** column. If rectifiers have previously been mapped to this source, they will show as selected. Click **Next**.
3. The **Review** step will show the changes requested. Pressing **Cancel** at this time will discard your changes. Click **Next** to accept your changes.

The chosen rectifiers will be mapped to this AC Source.

 **Note:** *The rectifier mapping can also be changed one-by-one for each rectifier, in the **System > DC System > Inventory > Rectifiers > Phase Mapping** table.*

 **Note:**

*The rectifiers can also be assigned to a particular phase. This can be done through the **System > DC System > Inventory > Rectifiers > Phase Mapping** table.*

*Rectifiers that are left at the default setting of **No Phase** will be assumed to belong to Phase 1. If a rectifier has been set to a phase that does not exist, that rectifier's voltage values will not be included in the voltage calculations for the AC Source.*

12.3. AC Generator

An **AC Generator** is a specialized type of AC Source which allows a generator to be started and stopped with a relay.

The standard condition on which to start or stop a generator is based on a voltage. The controller allows the user to choose any voltage in the system and set it as the **Voltage to Monitor**, with a start threshold and a stop threshold. The generator will be started if the **Voltage to Monitor** falls below the **Start Voltage Threshold**, and will be stopped if the **Voltage to Monitor** climbs above the **Stop Voltage Threshold**.

The optional start or stop conditions can be used to start and stop the generator based on other types of conditions. For example, the battery State of Charge could be used. The ability to use Custom Data or other system values gives the generator control a lot of flexibility; however, care must be taken to ensure that the start and stop conditions make sense. Otherwise, it is possible for the user to create, for example, a start condition that is always true, in which case the generator would not stop running.

The Minimum Runtime assures that the generator will not be started to only run for too short a period of time. Once the generator has started, it will continue to run for the Minimum Runtime even if a stop condition has become true.

The Maximum Runtime is intended to ensure that the generator does not continue to run indefinitely even if no stop condition comes true. After running for the Maximum Runtime, the generator will attempt to shut down. It should be noted that if a start condition is still true, it would start up again immediately. In that case, an event message will be logged. Additionally, there is a **Generator Running Too Long** alarm that may be enabled to help alert the user to this situation.

12.3.1. Create an AC Generator

To create an AC Generator:

1. Go to **System > AC Source System > Inventory**.
2. In the **AC Sources** table, click **Add AC Source**. The **Add AC Source** wizard will launch.
3. Set the **Name** to identify the AC Source Type.
4. Select **Generator** from the **AC Source Type** drop-down menu. Click **Next**.
5. Select the **Phase** for your **AC Source**. Click **Next**.
6. On the **Alarms** page, select whether the AC Input Fail alarm should be enabled for this source. Select **Yes** or **No**.
7. On the **Voltage Readings** page, select the system from where the AC Source will obtain its readings.
8. Review your settings and click **Next**.
9. In the **Results** step, there will be an option to run the **Configure Generator Control** wizard.
Alternatively, this wizard can be run from the **Generator Control** table within the details of the new AC Generator source.

If the user wishes to use the optional start and stop conditions to start and stop the generator, these may be configured in the **Optional Start/Stop Conditions** table.

Additionally, the alarms for **Generator Control** may be configured. The **Generator Status Mismatch** alarm will be active if there is a **Generator Status Signal Source** configured, and the status does not

match what is expected. For example, if the **Generator Command Status** indicates that the generator should be running, but the **Generator Status Signal Source** indicates that it is not (as reported in the **Generator Running** status field), the **Generator Status Mismatch** alarm will become active. Similarly, if the **Generator Command Status** indicates that the generator should not be running, but the signal indicates that it is, the alarm will activate. The **Generator Running Too Long** alarm is disabled by default. If enabled, it will indicate if the generator has run past the **Maximum Runtime** due to a start condition that is still true.

12.3.2. Configure Generator Control

You can access the **Configure Generator Control** wizard from the **Creating an AC Generator**.

To configure the AC Generator:

1. Run the **Configure Generator Control** wizard. This can either be run directly from the results page of the **Add AC Source** wizard, or launched from **System > AC Source System > Inventory > AC Source** page.
2. In the **Generator Control** dropdown menu choose from the following:
 - **Enabled** Chose enabled if the generator can be controlled by a relay.
 - **Disabled** If disabled is chosen no further configuration is required.
3. Under **Generator Control Signals** select the **Generator Control Relay** and the **Generator Status Signal Source**. Click **Next**.

 **Note:** The **Generator Control Relay** is mandatory as it is the relay that will be used to start and stop the generator.

 **Note:** The **Generator Status Signal Source** is optional, but it should be mapped to a digital input which can be used to monitor whether or not the generator is running.

4. Under **Voltage to Monitor**, choose a voltage signal to be monitored.
 - a. Enter a **Start Voltage Threshold**.
 - b. Enter a **Stop Voltage Threshold**.
 - c. Click **Next**.
5. Review your settings and click **Next**.

The generator has now been configured.

13. FXM-HP Systems

For the components and functions of a FXM-HP system, please see Alpha FXM-HP 650, 1100, 2000 UPS Product Manual, Technical Guide: 0170022-J0.

14. Controller Redundancy

For information on the Controller Redundancy function, please see the Controller Redundancy Integration Guide.

15. Power Flow

This section provides an overview of the **Power Flow** feature.

15.1. Introduction to Power Flow

Power Flow is only available via the web interface of the controller. From the main dashboard, it displays live information about the power system and its inventory items, as well the relationships and the flow of power between them.

Power Flow is intended to be a single point for monitoring and troubleshooting the system. Key information and alarms are shown and you can use Power Flow to quickly drill down and investigate any alarms. A **Power Flow** for a **DC System** is shown below.

Figure 71. Power Flow for a DC System

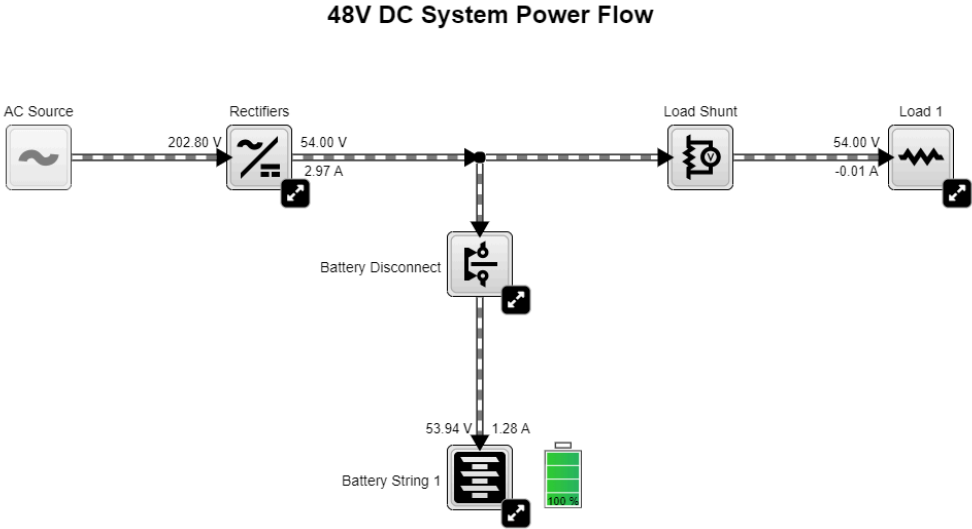

15.2. Accessing the Power Flow

Power Flow can be accessed through the menu bar in the web interface. If a system that is supported by Power Flow has been created, the **Power Flow** for that system will automatically appear in the drop down as shown in the figure below.

Figure 72. Navigating to Power Flow

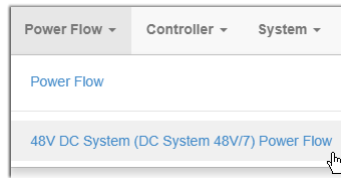

Note: In version 6.20 Power Flow supports **DC, AMPS HP2, Distribution, and Line Power Systems, and Battery Subsystems**. If your site has one or more of these systems, go to **Controller > Inventory** to create them.

15.2.1. Getting Help

Help for the Power Flow feature can be accessed from any **Power Flow** by clicking the **Help** icon.

15.2.2. Using Power Flow Configuration Suggestions

Power Flow can detect a missing configuration from the system's inventory. In such instances, a special node will appear to allow quick configuration of the system. Clicking on the node will bring up a dialog to set the missing configuration.

Figure 73. Power Flow Configuration Suggestions

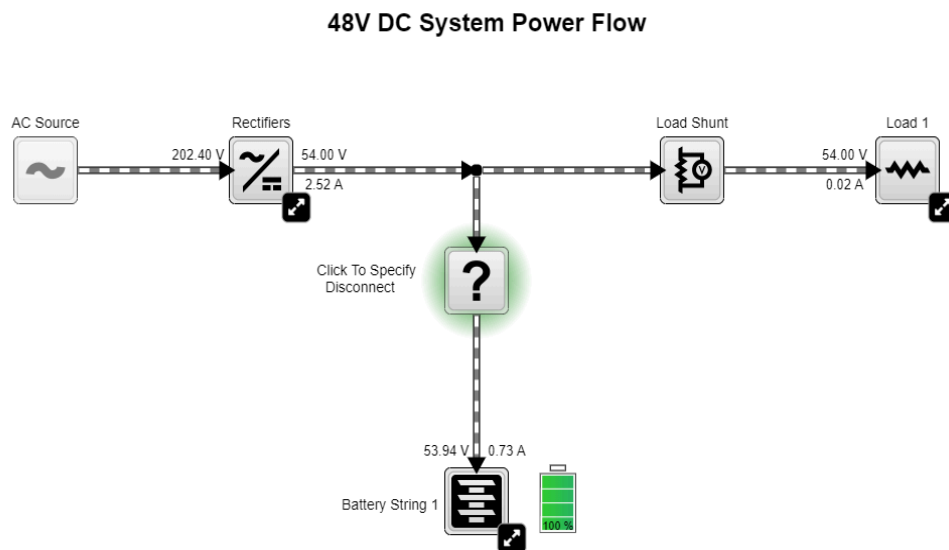

This feature can be disabled under **Controller > Configure Controller > User Interface Preferences > Power Flow Configuration Suggestions**.

15.2.3. Configuring the Default Power Flow

If your site has multiple systems supported by **Power Flow**, you can configure a default. The chosen **Power Flow** will display whenever you click **Power Flow** in the menu bar.

To set or change the default **Power Flow**, go to **Controller > Configure Controller > User Interface Preferences** and set the **Default Power Flow** field.

15.3. Interacting with the Power Flow

Power Flow is an interactive diagram, as such one can expand elements to view more information, or click on element icons to navigate. The figure below highlights the interactive elements of the Power Flow diagram.

Figure 74. Interacting with the Power Flow

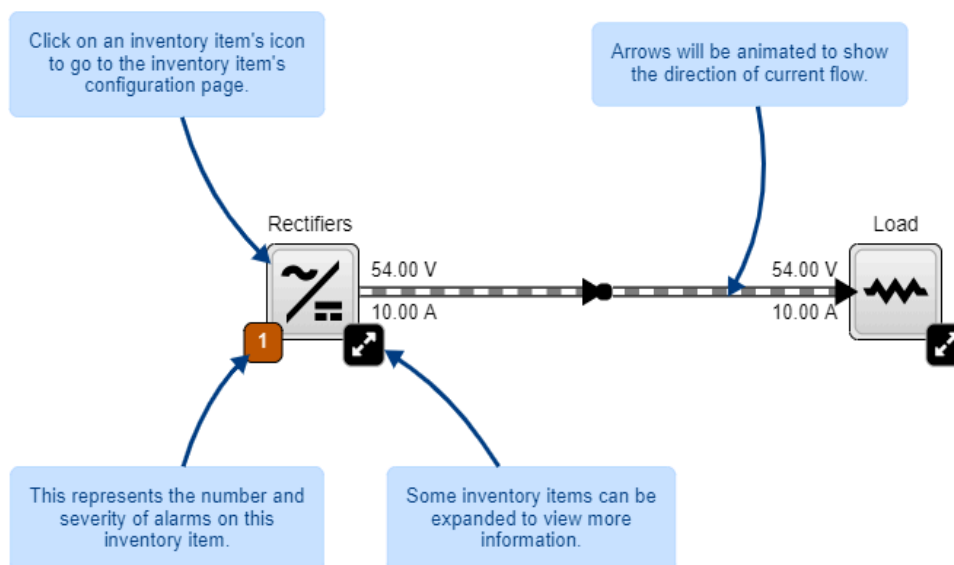

The controls are located alongside the Help button in the top left corner of the Power Flow. The **Expand All** button lets you immediately view all the details of the Power Flow by showing all fields and alarms. The **Collapse All** button returns the diagram to the compact status summary state.

Figure 75. Power Flow Controls

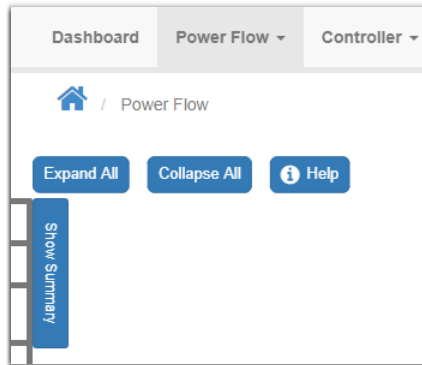

15.4. Controller Power Flow

The controller **Power Flow** presents an overview on the systems configured on the site and the flow of power between them. From here you can go to the Power Flow of individual systems by clicking on that system's icon.

Grayed out **Inventory** items are there to help draw a more complete picture, or can be placeholders for future systems.

Figure 76. Controller Power Flow

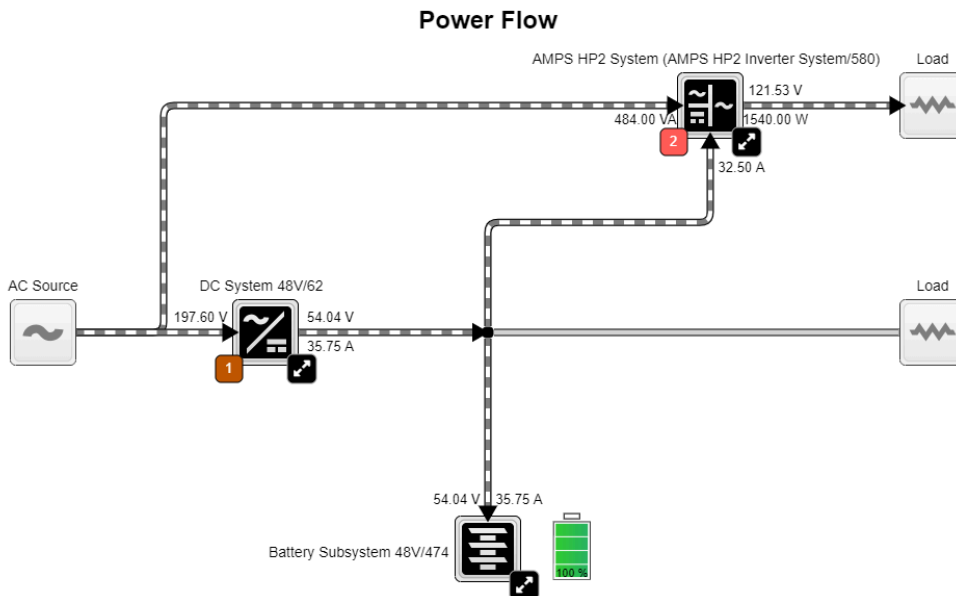

15.5. Power Flow for Systems Managed by Different Controllers

For systems that are managed by different controllers but are electrically connected, **Data Sharing** can be used together with the **Controller Power Flow** to visually see the flow of power between the two systems.

 **Note:** In version 6.20, **DC**, **AMPS HP2 Systems**, and **Battery System** can be shared and shown on the **Controller Power Flow**.

Figure 77. Using Data Sharing to Create Power Flow Across Different Controllers



Components drawn on Power Flow that are managed by a different controller will have a reference to the **Data Subscription** they originate from. Clicking on these references will navigate to the user interface of the managing controller.

16. Maintaining the System

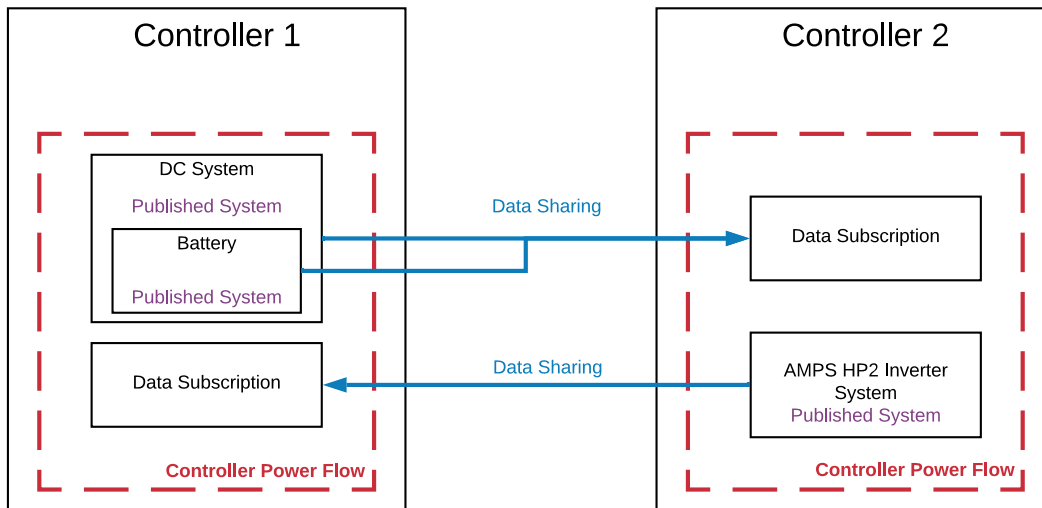
When maintaining your system always check for known issues within the readme file that ships with your software. This section of the manual covers the following:

- Rectifier maintenance
- Inverter and T2S maintenance
- LPS maintenance
- Batteries and battery maintenance
- LVD maintenance

16.1. Rectifier Maintenance

This section covers the following: rectifier alarms, rediscovering CAN devices and inserting unassigned modules.

16.1.1. Rectifier Alarms

Possible problems with rectifiers are indicated by either a Rectifier Minor or Rectifier Fail alarm. These alarms are activated if one or more rectifiers have active alerts. Individual devices that are normally controlled as a group, such as rectifiers, have alerts instead of alarms.

Go to the Troubleshooting section for more detailed information on rectifier alarms and alerts.

16.1.2. Insert Unassigned Modules

To assign rectifiers:

1. From the main menu go to **System > DC System > Inventory > Rectifiers > Status**.
2. In the **Modules Available for Assignment** table, click the **Assign** button next to the rectifier you want to assign. You can also assign all the rectifiers by clicking **Assign All**. If this table is empty, there are no compatible rectifiers detected.
3. The rectifier moves from the **Modules Available for Assignment** to the **Status** table and is automatically configured to match what is contained in **System > Inventory > Rectifiers > Configuration** menu.

16.2. Inverter and T2S Maintenance

This section covers inverter and T2S maintenance including: replacing, identifying, alarms and alerts, DC priority and AC input power limit.

Changing the System Configuration

Once the system has been created, most of the system configuration cannot be changed. The number of phases, number of DC groups and number of AC groups cannot be changed. If any of these values are incorrect the inverter system must be re-commissioned and all inverters unplugged.

Adding or Removing Inverters

If more inverters are needed to increase capacity, the **Add Inverters** wizard guides users through this process.

⚠ **Important:**

To ensure the T2S is configured correctly, it is necessary to use these wizards to add or remove inverters from the system. This ensures that the correct number of inverters, and the correct number of redundant modules in each phase. This is important for the operation of T2S alerts and alarms.

Figure 78. Add/Remove Inverters

Name	Phase	AC in Group	DC in Group	AC Output Power (VA)	Loading (VA)	DC in Current	Active Alerts	IO Status	Actions
TSI/65	0	0	0	0 VA	0 %	0.0 A	0	On	Locate
TSI/99	0	0	0	0 VA	0 %	0.0 A	0	On	Locate
TSI/113	1	0	0	0 VA	0 %	0.0 A	0	On	Locate
TSI/102	1	0	0	0 VA	0 %	0.0 A	0	On	Locate
TSI/5207	2	1	1	0 VA	0 %	0.0 A	0	On	Locate
TSI/132	2	0	0	0 VA	0 %	0.0 A	0	On	Locate
TSI/118	2	0	0	0 VA	0 %	0.0 A	0	On	Locate
TSI/2552	3	1	1	0 VA	0 %	0.0 A	0	On	Locate
TSI/136	3	0	0	0 VA	0 %	0.0 A	0	On	Locate
TSI/119	3	0	0	0 VA	0 %	0.0 A	0	On	Locate

Go to **System > Inverter System > Inventory > Inverters > Status** to access the **Add Inverters** wizard.

If inverters must be removed from the system, use the **Remove Inverters** wizard. Go to **System > Inverter System > Inventory > Inverters > Status** to access the **Remove Inverters** wizard.

16.2.1. Maintenance Bypass

For system configurations that use a generator for the AC input, the safest way to initiate a maintenance bypass is to follow the instructions in the **Initiate Zero Phase Shift** wizard. This wizard should be used whenever the inverter system has to be put into or taken out of bypass. This prevents the inverters from turning off when the bypass switch briefly short-circuits the AC input and output.

Go to **System > Inverter System > System Functions > Zero Phase Shift** to access the **Initiate Zero Phase Shift** wizard.

The wizard shifts the phase and voltage of the AC output to match the input.

16.2.2. Taking Power from DC Source

The inverter system can take power from the DC source (usually batteries) under three conditions:

1. AC mains is lost;
2. Manual DC Priority is enabled;
3. Input power limit is enabled.

When AC mains is lost, the inverters will always take power from the DC source if available.

16.2.2.1. Using Manual DC Priority

It is possible to manually instruct the inverters to take some amount of power from DC. This can be useful for testing or to manually reduce the AC input power during peak periods. When both **Manual DC Priority** and **AC Input Power Limit** are enabled, the feature with the higher resultant **Desired DC Input Power** will take priority. To use **Manual DC Priority**:

1. Go to **System > Inverter System > System Functions > Manual DC Priority**.
2. From the Manual DC Priority table, click the edit icon.
3. Select **Enable** in **Manual DC Mode** drop-down menu and click save.
4. Click the edit icon to set the **Desired DC Input Power** to the desired value. This value is a percentage of output power that will be taken from DC (with the rest coming from AC input).
5. Disable **Manual DC Mode** when complete.

16.2.2.2. Using AC Input Power Limit

The AC Input power limit is a feature that allows the controller to dynamically adjust the amount of power taken by the AC input, by taking some power from the DC input. The controller will continue to take power from the AC input until a user configured power limit threshold is reached. At this point, the inverter system will begin to draw power from its DC bus. When both **Manual DC Priority** and **AC Input Power Limit** are enabled, the feature with the higher resultant **Desired DC Input Power** will take priority.

1. Go to **System > Inverter System > System Functions > AC Input Power Limit**.
2. Enable the **AC Input Power Limit**.
3. Set the **Desired AC Input Power** to the required value. The controller will attempt to limit the AC input power to this value by taking some power from the DC input.
4. Disable **AC Input Power Limit** when complete or when the battery needs to be charged.

The battery may be depleted and require charging.

16.2.3. Replace Fan

The fan inside each inverter has a limited lifetime. When this lifetime has expired the inverter will have an active alert called **Fan Life Elapsed**. To prevent an unexpected fan failure that could compromise system redundancy, it is recommended that the fan be replaced when this alert occurs.

To clear the alert, go to **System > Inverter System > Inventory > Inverters > Status**, and click the details icon of the inverter with the alert, then press the **Clear Fan Life Elapsed Alert** button.

16.2.4. Identifying an Inverter

If an inverter is in alert it is usually necessary to identify and locate the inverter in the rack. There are two ways to do this:

1. Go to **System > Inverter System > Inventory > Inverters > Status**. This view shows all inverters within the system in a table view. One column within the table displays the number of active alerts. Find an inverter with an alert and click the **Locate** button. This will cause the LEDs on the front panel of the inverter to flash for two seconds.
2. You can also click the details icon of the inverter. This view shows the bay, shelf and slot ID of the inverter in the **Inverter Mapping** table. Normally this information is populated during system commissioning, but it can also be changed here in case it is incorrect or was not initially set.

 **Note:** *If these values have been set, use them to physically locate the inverter. If the values have not been set or appear to be incorrect, you can use the **Locate** button to find the inverter and set the bay, shelf and slot ID as required.*

16.2.5. Alarms and Alerts

The inverter system has a set of alarms that are generated by the alerts on the T2S and inverters. The system alarms are shown in the **Active Alarms** table.

To see all the active alerts within the system, go to **System > Inverter System > Live Alerts**. This live information comes from the T2S, and is the source of inverter system alarms.

When the inverter system has an active alarm, go to the **Live Alerts** table. The information in this table indicates which T2S or inverter to investigate to find the cause of the alarm.

16.2.6. Replacing a T2S

If a T2S fails and needs to be replaced, remove the old T2S and plug in the new T2S. Go to **Modules > All Modules** and use the Replace T2S wizard to partially transfer configuration from the old T2S to the new T2S. It may be necessary to wait for up to 20 minutes as the new T2S continues to be configured by communicating with the inverters.

If the system is not operating properly after waiting, then the system needs to be recommissioned for the T2S to be configured correctly. For a single T2S inverter system, follow the instructions below. If the inverter system has four T2Ss, refer to the chapter **Inverter System (Four T2S)**.

1. Unplug the failed T2S.
2. Go to **System > Inverter System > Inventory > T2Ss** and click **Forget All in Comms Lost**. The T2S will disappear from the table.
3. Insert the new T2S, and then wait for it to display in the **Modules Available for Assignment** table. It will take several minutes for the controller to acquire the new T2S. In general it is assigned to the system automatically, and displays in the **T2Ss** table. If it does not occur, use the **Assign All** button to do this manually.
4. Put the system in Bypass to keep the load powered during the commissioning process.

5. Go to **System > Inverter System > Configure System** and click the **Commission Inverter System** wizard in the **Configuration** table.
6. Follow the wizard instructions to recommission the system.
7. When completed, press the **Add Inverters** button to launch the add inverters wizard and add all the inverters to the system. You can also launch this wizard from **System > Inverter System > Inventory > Inverters > Status**.

The T2S has been replaced, and the inverter system has no active alarms.

16.2.7. Shelf Layout

Shelf layout is only available via the web.

When the inverters have been configured with bay, shelf and slot ID, the **Shelf Layout** page displays a physical view of the inverters, the alert status and the output power of each inverter. The text that shows the output power is a link that opens a new page to display the inverter details.

For inverter systems that use four T2S and TUS modules; TUS modules will display in the **Shelf Layout** page, but because they do not have bay/shelf/slot information they are only displayed in the table.

16.3. Line Power System Maintenance

This section covers line power system maintenance including: replacing LP modules, and turning off power to the loads.

16.3.1. Powering On and Off Line Power Loads

A line power load usually has multiple channels from different LP modules assigned to it. It may be necessary to occasionally power off then power on the load.

To power off or on a load:

1. Go to **System > Line Power System > Inventory > Line Power Loads** and click on the details icon for the load to be powered off.
2. In the **Status** table, verify that the **Channels** value is at least 1. The **Power On/Off** buttons will only work if there are one or more channels assigned to the load.
3. In the **Configuration** table, click the **Power Off** button. After a few moments, the **Channels Enabled**, **Total Output Current** and **Total Output Power** values in the **Status** table will go to zero. This indicates that the load has been turned off. The **Power Off** button will become disabled and the **Power On** button becomes enabled.
4. To turn on the load, press the **Power On** button.

16.3.2. Replacing Line Power Modules

If a line power module is found to have failed it can be easily replaced without losing any configuration.

To replace a module:

1. Go to **System > Line Power System > Layout** to identify the shelf and slot of the failed module. A module causing an alarm will be highlighted with a red border. If there is more than one module in alert it may be necessary to click on the channel, then click on the module details link to determine the cause of the failure.
2. Unplug the failed module and replace it with a new module.
3. Press the **Forget All in Comms Lost** button in order to clear the **LP Module Comms Lost** alarm.

The new module is acquired and its channels are automatically assigned to the same load that the old module was assigned to.

16.4. Battery Maintenance

This section covers the following: battery alarms, charging batteries and maintaining batteries.

16.4.1. Battery Alarms

To view the **Battery Alarms** menu go to **System > DC System > Inventory > Battery Subsystem**.

When the battery charge current exceeds the threshold, the **Battery Charge Current High** alarm is active. The alarm may occur during battery charging if there are large load fluctuations. The alarm can also be caused by an incorrect alarm threshold or battery charge current limit setting. The alarm will clear when the battery charge current is less than or equal to the threshold minus the hysteresis.

When the highest battery temperature value rises above the threshold, the **Battery Temperature High** alarm is active. The alarm will clear when the highest battery temperature value is less than or equal to the threshold minus hysteresis.

When the lowest battery temperature value has fallen below the threshold, the **Battery Temperature Low** alarm is active. The alarm will clear when the lowest battery temperature is greater than or equal to the threshold plus hysteresis.

When the battery breaker or fuse is open, the **Battery Breaker/Fuse Open** alarm is active. The alarm can occur when the digital input that detects the state of the breaker/fuse is active. The alarm may also be caused by incorrect or faulty wiring or incorrect digital input settings. The alarm will clear when the digital input is not active.

When the battery voltage minus the midpoint voltage measurement is greater than the threshold, the **Midpoint Unbalanced** alarm is active. The alarm can be caused by an imbalance in battery cells or blocks and may indicate an equalize charge is necessary. The alarm may also be caused by damaged or end-of-life cells. The alarm will clear when the difference between half the battery voltage and the midpoint voltage is less than or equal to the threshold minus the hysteresis.

Also available in the battery subsystem Alarms table are the alarms related to **System Functions** related to the battery, such as Temperature Compensation, Battery Runtime and Health, etc.

16.4.2. Charging Batteries

To access the charging menus go to **Systems > DC System > System Functions > Charging**. Note that you must have a battery defined in the DC System in order to have this menu item available under **System Functions**.

Figure 79. Battery Charging Tables

Bulk Charging Stage Status		
Name	Value	Actions
Charge Current Control State	Disabled	i
Charge Current Control Suspended Reason	---	i
Battery Capacity Rating	100 A h	i

Primary Charge Current Control		
Name	Value	Actions
Charge Current Control	Disabled	i
Charge Current Limit Amps	--- A	i
Charge Current Limit (C/X)	---	i

Absorption Charging Stage Status		
Name	Value	Actions
Start Elevated Absorption Charging		
Elevated Absorption State	Disabled	i
Time Remaining In Elevated Absorption	--- h	i
Terminate/Disallow Absorption	---	i

Absorption Charging Configuration		
Name	Value	Actions
Elevated Absorption Charging	Disabled	i
Elevated Absorption Arming Threshold	48.00 V	i
Elevated Absorption Voltage	55.00 V	i
Elevated Absorption Termination Threshold	5.0 A	i
Elevated Absorption Timeout	1.0 h	i
Terminate/Disallow Elevated Absorption When True	---	i

Lead acid batteries should be charged in three stages, which are constant-current charge, absorption charge and float charge. The constant-current charge applies the bulk of the charge and takes up roughly half of the required charge time; the absorption charge, also known as topping charge, continues at a lower charge current and provides saturation, and then goes into float mode.

Charge Current Control during bulk charging helps increase battery longevity by keeping the battery current to within specified limits. Charge current to the battery during recharge will be limited to a value as programmed in the **Primary Charge Current Control** table.

This value is derived from the battery manufacturer's specification sheet.

Charge current control may at times be suspended. For example: a large negative load current that indicates a fail current sensor. When this occurs **Charge Current Control State** will read **Suspended** and **Charge Current Control Suspended Reason** will describe the reason. This information can be used in assisting with troubleshooting.

Elevated Absorption charging can be used after a prolonged AC power failure, when the battery voltage has decreased to a low level. Once the batteries have decreased beyond the absorption low voltage threshold, the controller will enter an armed mode. When AC power returns, the system voltage begins to increase, which charges the batteries.

Once the system voltage increases to the high voltage threshold, the controller begins to absorption charge the batteries at the elevated absorption voltage for a period specified in the **Absorption Charging** table.

This is done to ensure the **Elevated Absorption Timeout** is not effectively reduced by the time it takes to recharge the battery back to nominal system voltage.

Elevated Absorption charging can be terminated on the battery current to prevent over-charging of the battery. Elevated Absorption will terminate when the battery current falls below the specified threshold. Elevated Absorption charging can also be terminated or prevented from starting by setting the **Terminate/Disallow Elevated Absorption When True** setting to a custom data condition.

Upon initial activation of elevated absorption charging, the battery current is checked to see if it has fallen below the **Elevated Absorption Termination Threshold**. When the battery current falls below the threshold, and remains below the threshold for thirty seconds, the absorption charging continues at the nominal system voltage. Once the charging current is low and stable the system returns to Float mode.

16.4.3. Maintaining Batteries

To view the **Battery Maintenance** menus go to **System > DC System > System Functions**. There are three sub menus related to battery maintenance: **Equalize and Boost**, **Battery Test** and **Battery Runtime and Health**. Note that you must have a battery defined in the DC System in order to have these menu items available under **System Functions**.

Figure 80. Battery Maintenance System Functions

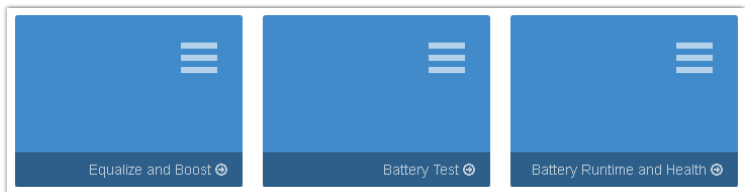

Equalize is a protective feature designed to ensure optimal lead acid battery life and performance. Over time, individual battery cell voltages may vary greatly. To ensure that batteries remain in optimum condition, they should be periodically equalize charged. An equalize charge is a forced overcharge, the . It removes sulfation that may have formed during low-charge conditions. This functionality can be started manually when the batteries are fully charged and floating.

Boost is similar to equalize but usually has a higher voltage. In order to start **Boost**, the **Terminate/Disallow Boost When False or '---** condition must be configured to a value to is true, or active. This is to provide a means to detect when dropping diodes have been switched into the bus first (between the rectifiers and the load), before allowing **Boost** to activate.

Refer to the battery manufacturer’s recommendations.

A **Battery Test** is used to verify the health of a lead acid battery.

Battery Runtime and Health provides detailed information about the battery.

Figure 81. Battery Runtime and Health Menu

Status			Configuration		
Reset Battery State of Health to 100%					
Name	Value	Actions	Name	Value	Actions
Estimated State of Charge (SOC)	---	% ⓘ	Battery Open Circuit Voltage	51.40 V	ⓘ
Estimated Battery Runtime	---	h ⓘ	Battery Estimation	Disabled	✎
Estimated Battery Health	---	% ⓘ	Load Model	Resistive	✎
			Battery LVD	---	✎

A battery run time prediction is performed while the battery is supplying power to the load. The controller collects data to estimate the time it will take the battery to be drained. If the battery estimation is enabled and the battery is sourcing current to the load, the estimated battery runtime if **AC Mains** is lost displays.

During an AC outage or battery test, data is collected to calculate the estimated state of charge and the estimated health of the battery. The accuracy of this data improves as the battery undergoes more discharge cycles.

16.4.3.1. Running a Manual Battery Test

Battery test parameters are found in **System > DC System > System Functions > Battery Test**. Note that you must have a battery defined in the DC System in order to have this menu item available under **System Functions**.

Status			
Start Manual Battery Test			
Name	Value	Actions	
Battery Test State	Inactive	i	
Time Remaining in BT	---	i	
Elapsed Time in BT	---	i	
Last Battery Test Completed	---	i	
Last Battery Test Error Condition	None	i	

Configuration			
Name	Value	Actions	
Battery Test Termination Voltage	44.50 V	edit	
Battery Test Timeout	8h	edit	
Battery Test Termination on SOC	Enabled	edit	
Battery Test Termination SOC	75 %	edit	

Automatic Testing			
Reschedule Next Test			
Name	Value	Actions	
Automatic Battery Testing Status	Inactive	i	
Interval Between Tests	180 d	edit	
Start Hour	0 h	edit	
Next Battery Test	---	i	
Days to Retry Failed Test	0 d	edit	
Retry Countdown	---	i	

Remote BT Configuration			
Name	Value	Actions	
Remote BT	Disabled	edit	
Remote BT Trigger Input	---	edit	
Remote BT Trigger State	---	i	

Alarms					
Name	Status	Limit	Priority	Relay	Actions
Battery Test	Disabled		Warning	---	Test Alarm edit

To run a manual battery test, the **DC System** must be in **Battery Conditioning** mode.

1. Go to **System > DC System > System Functions > Battery Test**.
2. In the **Configuration** table set the **Battery Test Termination Voltage** to the voltage at which the battery test should stop. A lower battery test termination voltage gives more accurate test results, but also generates more wear on the battery.

For high voltage rectifiers, or when using the rectifiers with extended voltage range, it is also important to set the **System > Inventory > Rectifiers > Configuration > Minimum Test Voltage** to a value below the **Battery Test Termination Voltage** or the rectifier may start to source current making the battery test results invalid.

3. In the **Configuration** table set the **Battery Test Timeout** to the maximum time to run the battery test.

4. In the **Configuration** table set the **Battery Test Termination SOC** the State of Charge at which the battery test should stop. A lower battery test termination SOC gives more accurate test results, but also generates more wear on the battery. The termination SOC must be less than 80% for the battery health estimate to work. Set Battery Test Termination on SOC to Enabled.
5. If the **DC System** is in **Battery Conditioning** mode, press the **Start Manual Battery Test** command in the **Status** table.

- The **DC System** mode should change to **Test Discharging**
- The **Time Remaining in BT** should start counting down
- The **Last Battery Test Error Condition** should have the value: **None**

16.4.3.2. Setting Up an Automatic Battery Test

In addition to the **Manual Battery Test**, you can set up an interval to schedule a regular battery test. Battery test parameters are found in **System > DC System > System Functions > Battery Test**. Note that you must have a battery defined in the DC System in order to have this menu item available under **System Functions**.

The screenshot displays five panels related to battery testing configuration:

- Status Panel:** Contains a 'Start Manual Battery Test' button and a table with columns 'Name', 'Value', and 'Actions'.

Name	Value	Actions
Battery Test State	Inactive	[Info]
Time Remaining in BT	---	[Info]
Elapsed Time in BT	---	[Info]
Last Battery Test Completed	---	[Info]
Last Battery Test Error Condition	None	[Info]
- Configuration Panel:** A table with columns 'Name', 'Value', and 'Actions'.

Name	Value	Actions
Battery Test Termination Voltage	44.50 V	[Edit]
Battery Test Timeout	8h	[Edit]
Battery Test Termination on SOC	Enabled	[Edit]
Battery Test Termination SOC	75 %	[Edit]
- Automatic Testing Panel:** Contains a 'Reschedule Next Test' button and a table with columns 'Name', 'Value', and 'Actions'.

Name	Value	Actions
Automatic Battery Testing Status	Inactive	[Info]
Interval Between Tests	180 d	[Edit]
Start Hour	0 h	[Edit]
Next Battery Test	---	[Info]
Days to Retry Failed Test	0 d	[Edit]
Retry Countdown	---	[Info]
- Remote BT Configuration Panel:** A table with columns 'Name', 'Value', and 'Actions'.

Name	Value	Actions
Remote BT	Disabled	[Edit]
Remote BT Trigger Input	---	[Edit]
Remote BT Trigger State	---	[Info]
- Alarms Panel:** A table with columns 'Name', 'Status', 'Limit', 'Priority', 'Relay', and 'Actions'.

Name	Status	Limit	Priority	Relay	Actions
Battery Test	Disabled		Warning	---	[Test Alarm] [Edit]

To run an automatic battery test, the **DC System** must be in **Battery Conditioning** mode.

1. Go to **System > DC System > System Functions > Battery Test**.
2. In the **Configuration** table set the **Battery Test Termination Voltage** to the voltage at which the battery test should stop. A lower battery test termination voltage gives more accurate test results, but also generates more wear on the battery.

3. In the **Configuration** table set the **Battery Test Timeout** to the maximum time to run the battery test.
4. In the **Configuration** table set the **Battery Test Termination SOC** the State of Charge at which the battery test should stop. A lower battery test termination SOC gives more accurate test results, but also generates more wear on the battery. The termination SOC must be less than 80% for the battery health estimate to work. Set Battery Test Termination on SOC to Enabled.
5. In the **Automatic Testing** table, set the **Interval Between Tests** to the number of days (e.g. 182).
6. In the **Automatic Testing** table, set the **Start Hour** to the time of day you want the test to start on (e.g. 3 for 3:00am).
7. *Optional:* In the **Automatic Testing** table, set the **Days to Retry Failed Test** to the number of consecutive days to retry a battery test if it fails to start.
8. In the **Automatic Testing** table, press the **Reschedule Next Test** button to calculate the date of the next test which is shown in the **Next Battery Test** field.

The **Next Battery Test** field displays the expected date and time of the next scheduled battery test.

16.4.3.3. Running a Remote Battery Test

Battery test parameters are found in **System > DC System > System Functions > Battery Test**. Note that you must have a battery defined in the DC System in order to have this menu item available under **System Functions**.

The screenshot displays the Battery Test configuration interface, divided into four main sections:

- Status:** Contains a 'Start Manual Battery Test' button and a table with columns 'Name', 'Value', and 'Actions'.

Name	Value	Actions
Battery Test State	Inactive	[Info]
Time Remaining in BT	---	[Info]
Elapsed Time in BT	---	[Info]
Last Battery Test Completed	---	[Info]
Last Battery Test Error Condition	None	[Info]
- Configuration:** A table with columns 'Name', 'Value', and 'Actions'.

Name	Value	Actions
Battery Test Termination Voltage	44.50 V	[Edit]
Battery Test Timeout	8h	[Edit]
Battery Test Termination on SOC	Enabled	[Edit]
Battery Test Termination SOC	75 %	[Edit]
- Automatic Testing:** Contains a 'Reschedule Next Test' button and a table with columns 'Name', 'Value', and 'Actions'.

Name	Value	Actions
Automatic Battery Testing Status	Inactive	[Info]
Interval Between Tests	180 d	[Edit]
Start Hour	0 h	[Edit]
Next Battery Test	---	[Info]
Days to Retry Failed Test	0 d	[Edit]
Retry Countdown	---	[Info]
- Alarms:** A table with columns 'Name', 'Status', 'Limit', 'Priority', 'Relay', and 'Actions'.

Name	Status	Limit	Priority	Relay	Actions
Battery Test	Disabled		Warning	---	[Test Alarm] [Edit]

1. Go to **System > DC System > System Functions > Battery Test**.

2. In the **Configuration** table set the **Battery Test Termination Voltage** to the voltage at which the battery test should stop. A lower battery test termination voltage gives more accurate test results, but also generates more wear on the battery.
3. In the **Configuration** table, set the **Battery Test Timeout** to the maximum time to run the battery test.
4. In the **Configuration** table set the **Battery Test Termination SOC** the State of Charge at which the battery test should stop. A lower battery test termination SOC gives more accurate test results, but also generates more wear on the battery. The termination SOC must be less than 80% for the battery health estimate to work. Set Battery Test Termination on SOC to Enabled.
5. In the **Remote BT Configuration** table, set the **Trigger Input** for the digital input being used to remotely trigger the battery test.
6. In the **Remote BT Configuration** table, set **Remote BT** field to **Enabled**. Once enabled, the **Trigger State** displays a value, either **Active** or **Inactive**.
7. Activate the digital input which was configured as the **Trigger Input** and the a battery test starts.
 - The **Trigger State** in the **Remote BT Configuration** table should go **Active**
 - The **DC System** mode should change to **Test Discharging**
 - The **Time Remaining in BT** should start counting down
 - The **Last Battery Test Error Condition** should have the value: **None**
 - A remote battery test is started when the **Trigger Input** goes from **Inactive** to **Active**.
 - A remote battery test is normally terminated when the **Trigger Input** goes from **Active** to **Inactive**. As a safety measure, the battery also terminates if the voltage drops below the termination voltage threshold or the test times out.

16.4.4. Battery Temperature Compensation

To view the battery temperature compensation go to **System > DC System > System Functions > Temperature Compensation > Status**. Note that you must have a battery defined in the DC System in order to have this menu item available under **System Functions**.

Battery temperature compensation uses the temperature probes connected to the temperature inputs on the ADIOs which are part of the system. This feature will not function optimally if these probes are damaged or disconnected from the system.

To view the values of the temperature inputs go to **Modules**, and then click the ADIO(s) that have battery temperature probes attached. Confirm all probes are working correctly and the temperatures are reasonable.

16.5. Low Voltage Disconnect (LVD) Maintenance

Low voltage disconnects (LVDs) are used to disconnect loads or the battery during low voltage conditions. When an LVD activates, the system displays an alarm and a message. There can be a deep discharge of the batteries during an AC fail. Discharging the battery to an extremely low voltage can cause damage to the load and to the battery. The LVD is used to disconnect the battery, or one or more loads during

extremely low voltage conditions to avoid damage to the load or the battery. Once AC power returns, and the low voltage condition no longer exists, the LVD automatically reconnects the loads.

Disconnects allow you to program a number of different disconnect or connect conditions. Creating multiple LVD controls provides the capability of load shedding, which means the least critical loads are disconnected first.

Conditions that could trigger an LVD are as follows:

- Disconnect at disconnect voltage threshold; connect at connect voltage threshold.
- Disconnect at time after AC Fail; connect at connect voltage threshold
- Disconnect when Battery State of Charge (SOC) falls below a threshold; connect when SOC is 5% above SOC threshold.

 **Note:** *If the LVD were to disconnect, the calculated SOC value displays as “- -”. The LVD only reconnects once the SOC value is properly calculated again, which happens once the battery is reconnected and fully charged.*

- Up to three user definable disconnect and reconnect conditions.

 **Note:** *The connect voltage should be higher than the disconnect voltage by at least 1V for a 48V system and 0.5V for a 24V system.*

Each disconnect can have three digital inputs defined to close the loop on the status of the contactor.

- **Disconnect Open Source:** Indicates whether the disconnect is open or closed
- **Manual Closed Source:** Disconnect is set to stay closed
- **Manual Open Source:** Disconnect is set to stay open

To view the **Disconnects** menu, go to **System > DC System > Inventory > Disconnects**.

17. Maintaining the Controller

When maintaining your controller always check for known issues within the readme file that ships with your software. This section of the manual covers the following:

- Ethernet communications
- Working with alarms
- Controller maintenance
- Working with logs
- User account maintenance
- File maintenance

17.1. Ethernet Communications

By default, the rear Ethernet port on the controller is configured to acquire an IP address automatically, and the front Ethernet port is configured to use a static IP address of 10.10.10.201. The LCD can be used to view and configure the IP addresses that are being used on both Ethernet ports.

To view or configure the IP addresses:

1. From the LCD main dashboard click **Shortcut**, and then press **Ethernet**.
2. The LCD displays the IP address currently used on both Ethernet ports.
3. Click to highlight the row of the port you want to view or configure.
4. Press the arrow on the right-side of the screen and then LCD displays the menus: **Status**, **IPv4 Address**, **IPv6 Addresses** and **Configuration**.

To change the IP address settings:

5. Select the **Configuration** menu to highlight, then press the arrow on the right-side of the screen to enter.
6. Select **Change Network Configuration** to highlight that row, and then click the arrow on the right-side of the screen to start the wizard.
7. Enter the desired IPv4 settings using the **Previous**, **Next** and **Cancel** buttons.
If you are configuring a manual IPv4 address, you must supply all four values: address, subnet, gateway and DNS server. If you do not know the DNS server address, you can set it to 0.0.0.0. If you do not have a gateway address, it is common to substitute the number 1 for the last entry. So, if your IP address is 192.168.0.90, then you can set your gateway to 192.168.0.2.
8. When complete, click **Finish** and the changes are applied.
9. Click the back arrow, on the upper-left side of the screen twice and go back to the **Ethernet** screen to confirm the new settings.

On the Ethernet screen, verify that the new IP address settings are in use.

17.1.1. Connecting via the Web

By default, the rear Ethernet port of the controller is configured to acquire an IP address automatically and the front Ethernet port is configured to use a static IP address of 192.168.0.90.

To configure the IP addresses via the web:

1. From the main dashboard, go to **Controller > Configure Controller > Communications > Ethernet**.
2. In the **Ethernet** table, click the more details icon on the row you want to configure.
3. In the **Configuration** table, click **Change Network Configuration** and follow the steps in the wizard.

From the **Ethernet** table, view and verify the new IP address settings.

 **Note:** If you change the IP address that you are using, you will need to type the new IP address into your browser so that you can log in again.

17.2. Working with Alarms, Alerts and Hints

17.2.1. Active Alarms

When there are active alarms in the system, both the LCD and Web interface display these alarms prominently.

Depending on how the alarms are configured, an internal speaker (if present and installed) may sound an alarm tone, and one or more relays may be activated. The internal speaker is intended to give the on-site technician audible notification that an alarm is active. The relays are intended to give external monitoring equipment notification through a relay contact closure (or opening) that an alarm is active.

On both the web interface and the LCD screen, the top left region of the page displays the most recent alarms in order of the highest priority. This area of the display will be red when there are critical or major alarms, yellow for minor alarms, and green if there are only warnings or no alarms. Clicking this region takes you to the **Active Alarms** table where you can get more details.

The **Active Alarms** table displays the name of the alarm, time of activation, priority and status. The status of an active alarm can be active or acknowledged. An alarm moves from the active to the acknowledged state when the alarm cut-off (ALCO) button is pressed. The ALCO button is at the top of the **Active Alarms** table.

On the Web interface there is also a small ALCO button in the **Active Alarms** region of the main dashboard that will acknowledge any active alarms, and then take you to the **Active Alarms** list.

On the LCD screen, ALCO can also be accessed via the **Maintenance** button on the main dashboard.

To view details of an active alarm click the more details icon on the right-side of the row in the **Active Alarms** table. This screen shows you the state of the alarm, time of activation, time of acknowledgment, priority and the relay that is mapped to the alarm. To get troubleshooting information about the alarm, press the information icon beside the row that shows the alarm state.

17.2.2. Alerts

Alerts are status information that is read from modules. An alert can only be **Active** or **Inactive** and has no user configuration.

A list of all active alerts is viewable from the **Active Alarms** page on the web interface. To view the alerts on the LCD, press the active alarm area on the dashboard. The **Alerts** button will have a count of how many active alerts are present. Alerts can also be viewed on a module details view from the **Modules** page.

Active alerts may mean that the modules are not properly configured, or in some cases may mean the module has failed.

17.2.3. Hints

A hint is information about the controller or a system that may help with how to configure the controller, or indicate the controller is in a particular state. Hints can be hidden and restored depending on whether they are relevant for the configuration.

To view the details of a hint, go to **Alarms > Active Alarms** and click the pencil icon beside the hint to be viewed in the **Hints** table. This details view will provide useful information about why the hint is being shown, and what parts of the controller may be affected. If this hint is related to configuration, there will be a button beside the **Hide Hint** button to assist in fixing the configuration issue, which will in turn make the hint go away.

17.2.3.1. Hiding Hints

Follow the instructions below to hide or show hints.

1. Go the screen that shows the Hints.
 - From the dashboard of the LCD, press the dashboard area, then press the **Hints** button to show any visible hints.
 - From the web interface, click **Alarms** on the menu bar and view the **Hints** table.
2. Click on the details button of the hint to be hidden.
3. Click the **Hide Hint** button. A popup will appear indicating that the hint will disappear and not appear again until something changes related to the hint, or if the **Show All Hidden Hints** button is pressed. Click **Yes**.
The hint is now removed from the table.
4. To view all hidden hints again, click the **Show All Hidden Hints** button on the Hints table.
It is possible to hide all hints in the table by clicking the **Hide All Hints** button.

17.2.4. Alarm Cut-off

The Alarm Cut-Off (ALCO) button is used to silence the speaker (if installed) while technicians are investigating and troubleshooting an active alarm. ALCO can also be configured to deactivate alarm relays.

ALCO functionality is configured via **Alarms > Alarm Cut-off Settings and Global Alarm Settings**.

ALCO can be configured to either:

- Acknowledge active alarms, deactivate relays, and silence speaker
- Or silence the speaker only

When ALCO is pressed, the user configured ALCO period begins to countdown. When the count down reaches zero the ALCO period expires.

When ALCO expires the configured action is canceled. If you configured ALCO to acknowledge active alarms, deactivate relays, and silence speaker then alarms return to the active state which means the alarm relays are activated and the speaker begins sounding. If you configured ALCO to silence the speaker only, the speaker will start sounding as long as there are active alarms.

If a new alarm activates after ALCO is pressed, the speaker will sound the appropriate alarm tone. Any existing alarms that have been acknowledged from a previous ALCO press will remain acknowledged.

17.2.5. Alarm Activation Delay at Startup

Depending on system configuration there may be some alarms that activate shortly after startup then clear a few seconds later. These nuisance alarms are often caused due to the time it takes for the controller to re-acquire modules on the CAN bus. To prevent these alarms from activating and triggers relays or SNMP traps there is a setting that delays alarm activation at startup.

The alarm delay is configured under **Alarms > Alarm Cut-off and Global Alarm Settings**.

The default value of 30s works for most systems, however this value can be increased to accommodate systems that have a slower start up time, i.e. large inverter systems.

17.2.6. Alarm Summary Relays

There are three alarm summary relays that can be configured on the controller. These relays are connected to external monitoring equipment which provides a notification when the controller enters an alarm state.

- Controller Critical Relay
- Controller Major Relay
- Controller Minor Relay

To view them go to **Controller > Configure Controller > Alarms and Alarm Summary Relay**.

The relay mapped to the **Controller Critical Relay** is active whenever one or more critical alarms are active. Both **Controller Major Relay** and the **Controller Minor Relay** work in the same way.

17.2.7. Creating User Alarms

The controller has a set of default standard alarms that are associated with a system or an inventory item such as a load or a disconnect. These standard alarms may be enough to support many system configurations. It is also common to need additional alarms, based on the status of the digital inputs or on the threshold of an analog value read from the input of an ADIO device.

You can create any number of digital or threshold alarms. These alarms have the same behavior as standard alarms such as alarm cut-off, SNMP traps, and relay mapping. These user-defined alarms can be created and removed via the **Controller > Advanced Functions > User Alarms** menu.

To create a user alarm:

1. Go to **Controller > Advanced Functions > User Alarms**.
2. Select the type of user alarm to create. A new row for the user alarm will display in the table.
 - If you want to create a digital alarm click the **Add Digital User Alarm** button.
 - If you want to create a high or low threshold alarm click the **Add Threshold User Alarm** button.
3. Click the details icon. Two tables display. One table shows the fields to configure that are specific to the selected user alarm. The other table shows the standard alarm configuration.
4. Give the alarm a descriptive name. This is important since the same type of user alarms have the same default name. The alarm description is optional.
5. Select the alarm input source. There are different options depending on the type of user alarm you are creating.
 - A threshold alarm allows you select from ADIO voltage and temperature inputs, current readings from shunts or DCCTs and any status count data about rectifiers or converters.
 - A digital alarm allows you to select digital inputs on any ADIO devices.
6. Set the priority and relay. If you want to set a severity value for the SNMP trap, use the Parameter 1 field.
7. If you are configuring a digital alarm, this is all that is required. If you are configuring a threshold alarm, continue as described below.
8. Select the type of threshold alarm from the Alarm When Value field.
 - Selecting Above turns this alarm into a high threshold alarm.
 - Selecting Below turns this alarm into a low threshold alarm.
9. Set the threshold. For a high threshold alarm to activate, the source value must be greater than this value. For a low threshold alarm to activate, the source value must be less than this value.
10. Set the hysteresis. The hysteresis is important when using an alarm input source that may be noisy or fluctuate periodically. Be sure to set the hysteresis large enough to avoid false alarms, but not too large to prevent the alarm from clearing properly.

The new alarm has been configured. Whenever possible, test to ensure that new alarm operates as expected.

17.3. Controller Maintenance

This section of the manual covers the following:

- Restarting the controller
- Powering down the controller
- Changing the date and time
- Changing the controller language

- Changing user interface strings

17.3.1. Restarting the Controller

You can perform a restart via the web or the LCD screen of the controller. This first procedure covers restarting from the web.

⚠ CAUTION: *Ensure that a backup has been performed before starting this process. Use the Backup feature accessed through the LCD at **Shortcuts > Backup**.*

⚠ CAUTION: *Ensure that the controller software or operating system software is not being updated.*

From the web do the following:

1. From the main dashboard go to **Controller > Controller Status**.
2. Click the **Restart Controller** Button.
3. Click **Restart** when prompted.
4. The **Controller Restart** window displays progress via a blue bar.

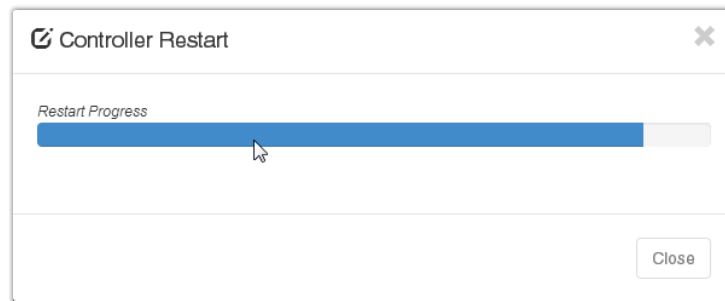

5. The controller screen goes black, and the LEDs lights cycle while restart is in progress.

Once complete, the Login page displays on the web, and the Cordex™ HP logo displays on the controller.

17.3.2. Restarting via the LCD

⚠ CAUTION: *Ensure that the controller software or operating system software is not being updated.*

To restart the controller via the LCD:

1. From the main dashboard of the controller, click **Shortcuts**, then click **Restart**.
2. Click the **Execute** button to confirm.

The front screen blacks out, and the LED status lights cycle until the restart is complete. Once the restart completes, the Cordex™ HP logo displays.

17.3.3. Powering Down the Controller

Sometimes it may be necessary to power down the controller to replace, remove or repair rectifiers.

 **CAUTION:** *You must use the LCD or web interface to reset the controller. This ensures that recent changes and files are saved properly.*

1. From the main dashboard, go to **Controller > Controller Status** and then click controller reset.

- or -

2. From the main dashboard of the controller, click **Shortcuts**, then click **Reset**.
3. Click the **Execute** button to confirm.
4. While the controller LEDs are performing a chase pattern, power down the controller by removing the power pin on the right-side of the controller.

After a reset, the controller LEDs will perform a chase pattern that indicates that the controller is booting. It is safe to remove power while the controller is booting. Once that chase pattern stops, the boot sequence is over and it is no longer safe to remove power.

17.3.4. Changing the Time and Date

There are three options to change the date and time:

- manually with the date/time picker
- using the local browser/computer
- using simple network time protocol (SNTP)

To set the date and time:

1. Go to **Controller > Configure Controller > Time and Date**.
2. From the drop-down **Time Zone** menu, select your time zone, and then click **Save**.
3. If setting the time manually, click the edit icon beside the **Current Time and Date**. Use the date/time picker to change the date and time.
4. If setting the time and date with the local browser click **Synchronize Time and Date to Web Browser**. This reads the time from the browser and sends it to the controller.

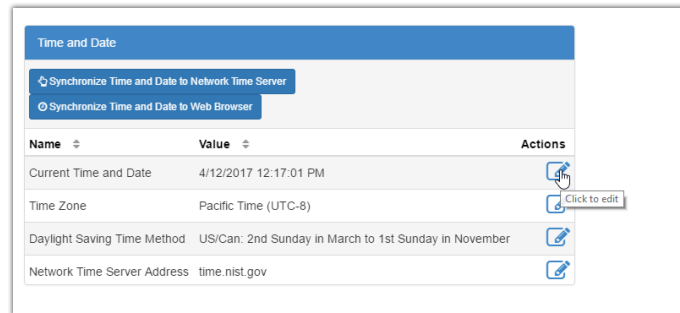

5. If setting the time and date using SNTP, first enter a valid SNTP server address, and then click **Synchronize Time and Date to Network Time Server**. If you do not want to use the SNTP server, clear the **Network Time Server Address** field.

It is common for gateways and routers to also be SNTP servers. If you are unsure of a valid SNTP server address, try using the controller's assigned gateway/router address. If this does not work, consult your IT personnel.

The controller time and time zone have been correctly set.

 **Note:** Whenever the time or time zone has been changed, an entry is recorded in the event log.

17.3.5. Changing the Default Login Language

Changing the default login language affects the language displayed on both the LCD and the web.

To change the default login language from the web do the following:

1. Go to **Controller > Configure Controller > User Interface Preferences**.
2. In the **User Interface Preferences** table, find the **Default Login Language** row and click the edit icon.

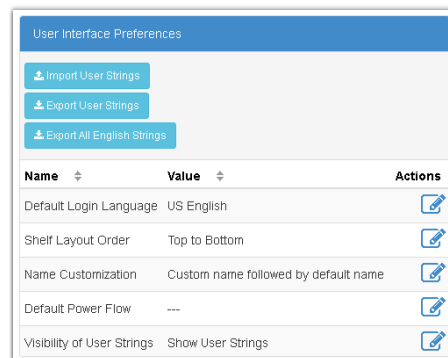

- From the drop-down menu, select your language preference, and then click **Save**.

17.3.6. Changing User Interface Strings

In rare occasions it may be desired to change some of the strings displayed on the user interface to conform to local terminology standards. The controller allows a user to download a strings file that can be edited in a spreadsheet program. The strings file can then be uploaded to the controller and after a restart, the changed strings will be used.

Note:

Use of this feature must be approached with caution as it may result in undesired consequences:

- *Editing the strings requires familiarity with a spreadsheet program in order to correctly import the file and save the file with UTF-8 encoding.*
- *Edited strings that are longer than the original can distort the user interface and make navigation difficult.*
- *Spelling or grammar errors can make the user interface hard to understand.*
- *Uploading an incorrectly generated strings file can result in unexpected or missing strings that make the interface unusable.*
- *The changed strings can result in confusion when seeking technical support since the user interface may be unfamiliar to support personnel.*
- *Strings on the OLED display cannot be changed.*

To change one or more strings on the user interface do the following:

- Go to **Controller > Configure Controller > User Interface Preferences**.

2. In the **User Interface Preferences** table, click the **Export All English Strings** button. The file will be downloaded to the PC (when using the WEB UI) or to a USB drive (when using the LCD UI). It is also possible to only export previously uploaded user strings by clicking the **Export User Strings** button.
3. Import the file as a UTF-8 encoded CSV file to a spreadsheet program. Failure to do this may result in missing or unexpected strings.
4. Make the necessary edits to the strings in the second column. Do not change anything in column 1 or strings may not be imported as expected.
5. Save the file as a UTF-8 encoded CSV file. Failure to do this may result in missing or unexpected strings.
6. Press the **Import User Strings** button and select your strings file. If using the LCD UI, the uploaded filename must contain the word "strings" and end in ".csv".
7. Restart the controller to load the new strings.
8. On startup, the new strings will be loaded. Any errors found while loading the new strings will be logged into the event log.

When interacting with technical support, you may be requested to hide the user strings from the user interface. To do this go to **Controller > Configure Controller > User Interface Preferences** and change the **Visibility of User Strings** setting to **Hide User Strings**. Restart the controller. The strings can be shown again by changing the setting to **Show User Strings** and restarting the controller.

17.3.7. Changing the Web Session Language

To support situations where users want different language options, you can change the language used for a specific login session. Most corporate security policies ban the storage of browser cookies, which means that the browser will not remember your selection from login to login so you need to select your web session language each time you login.

 **Note:** *Without cookie support, if you force a refresh (F5 for most browsers), the browser will not remember the language selection and you will need to change the web session language again.*

To change the web session language do the following:

1. Go to the top right corner of the web page.

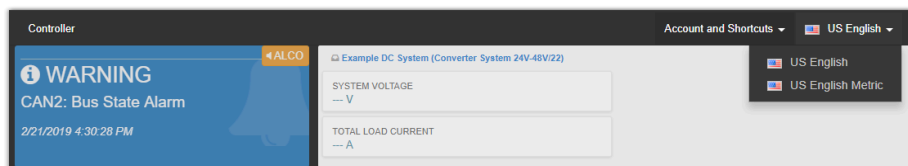

2. From the Account and Shortcuts drop-down menu, select your language preference.

17.3.8. Changing the System Status Bar

By default, the controller dashboard displays your systems in the original order created, from left to right. The **System Summary Option** is **Automatic** by default but can be customized to display up to four systems slotted in any order required. This is done via the **System Summary Option**, in the **Web Server Preferences** table.

To customize the system status bar view:

1. Go to **Controller > Configure Controller > User Interface Preferences**.
2. In the **Web Server Preferences** table, select **System Summary Option**.
3. From the **System Summary Option** drop down menu, select how many systems to display, and then click **Save**.

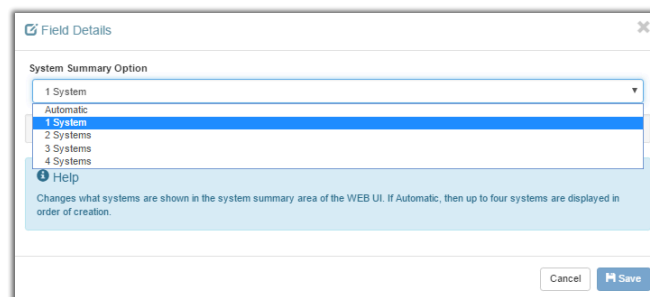

4. To change which system displays in the left most area of the system status bar, click edit for 1st system, and then select an option from the drop-down menu.

Web Server Preferences		
Name	Value	Actions
System Summary Option	1 System	
1st System	DC System 48V/4064	
2nd System	---	
3rd System	---	
4th System	---	

5. Continue to assign systems to the 2nd, 3rd, and 4th slots as required.

The system status bar displays the selected systems in the order selected.

17.3.9. Changing the Dashboard Values

It is possible to change the values that show for a system on the **System Status Bar**, the **LCD Dashboard**, and the **Web UI Dashboard**.

To change which values appear for a system:

1. Go to **Controller > User Interface Preferences**.

2. Look at the table for the system you wish to configure (for example, DC System 48V Dashboard Values).
3. Click the edit icon beside the **Dashboard Value** you would like to edit.

 **Note:** *The values in this table will appear on the different dashboards in the order they appear in this table (for example, **Dashboard Value 1**, then **Dashboard Value 2**, etc.). To change the order, set the fields in this table in the desired order.*

4. Select the value to show for this **Dashboard Value**, then click **Save**.

The new value selected will appear in the position of the **Dashboard Value** that was configured.

17.3.10. Data Sharing

The Data Sharing feature allows to share individual data point, or select systems between controllers. This data sharing feature consists of two parts:

- Published Data
- Data Subscriptions

Data sharing can be useful in situations where systems were installed at different times. These systems may have different controllers, but share the same bus (for example, a DC System was installed, then later-on, an AMPS System was installed, each with their own controllers).

Using this feature, the AMPS System controller provides the DC System controller with data on how much DC Input Current it will require during an outage.

The DC System controller provides the AMPS System controller with data on how much runtime the battery has remaining.

17.3.10.1. Sharing Published Data and Systems

Each controller can publish ten data points and up to five systems which other controllers can read and use for various purposes.

 **Note:**

Currently the data points are limited to numeric data and only DC, AMPS HP2 systems, and Battery can be published.

To share which Published Data or which Published Systems should be shared with other controllers:

1. Go to **Controller > Configure Controller > Communications > Data Sharing > Published Data and Systems**.
 - **Published Data** - click the edit icon next to one of the published values.
Select the data point to be shared with other controllers, then click **Save**.
 - **Published Systems** - click the edit icon next to one of the published values
Select the system to be shared with other controllers, then click **Save**.
2. This process can be repeated to share multiple data points or systems with other controllers.

After performing the above procedure, other controllers will be able to subscribe to this controller to receive data from it.

17.3.10.2. Data Subscriptions

Data Subscriptions are a way for users to read and use **Published Data and Systems** from other controllers.

To configure a **Data Subscription**:

1. Go to **Controller > Configure Controller > Communications > Data Sharing > Data Subscriptions**.
2. Click **Add Data Subscription**.
3. Click the more details icon to go into the details of this newly created **Data Subscription**.
4. Click the edit icon beside **IP Address**, enter in the IP address of the controller to read data from, then click **Save**.

After configuration, the **Data Subscription** will start reading any configured **Published Data and Systems** from the remote controller. Data will be read and updated every ten seconds.

If there are any problems communicating with the remote controller, those will be indicated in **Communication Status**, potentially being raised as an alarm through the **Communication Error** alarm. Some common errors could be:

- IP address configured incorrectly
- The controller or the remote controller are not connected to any network, not connected to the same network, or not publicly visible
- No published data configured on the remote controller (this will be indicated as a **No Published Data** status)

17.4. Working with Logs

This section of the manual covers the following:

- Events and Alerts Log
- Battery Log
- Power Outage Log
- Datalogs
- Performance Log

17.4.1. Event and Alert Logs

Figure 82. Events and Alerts Log

Events					Module Alerts				
Time	Source	Name	Value	Actions	Time	Source	Name	Value	Actions
11/3/2016 11:16:58 AM	Web User	Logon	admin		11/3/2016 9:31:14 AM	T2S Inverter Controller(2432)	CAN Communication Status	Now: Normal	
11/3/2016 11:15:39 AM	Web User	Logon	admin		11/3/2016 9:30:43 AM	314100240	Mode	Now: Supplying Power	
11/3/2016 10:53:37 AM	DC System 48V3696	AC Mains Voltage Low	Active		11/3/2016 9:30:43 AM	L-ADIO(37500225)	CAN Communication Status	Now: Normal	
11/3/2016 9:31:18 AM	DC System 48V3696	System Mode	Now: Battery Conditioning		11/3/2016 9:30:43 AM	314100240	CAN Communication Status	Now: Normal	
11/3/2016 9:31:18 AM	DC System 48V3696	Battery Conditioning	Now: Float		11/2/2016 4:16:08 PM	T2S Inverter Controller(2432)	CAN Communication Status	Now: Normal	
11/3/2016 9:31:03 AM	Inverter System(3686)	Inverter Comms Lost	Inactive		11/2/2016 4:15:38 PM	314100240	Mode	Now: Supplying Power	
11/3/2016 9:30:59 AM	Controller	Temporary License In Use	Inactive		11/2/2016 4:15:38 PM	L-ADIO(37500225)	CAN Communication Status	Now: Normal	
11/3/2016 9:30:57 AM	Inverter System(3686)	System Mode	Now: Unlicensed - Disabled		11/2/2016 4:15:38 PM	314100240	CAN Communication Status	Now: Normal	
11/3/2016 9:30:53 AM	Command	Disable Temporary License			11/2/2016 11:04:34 AM	314100240	Mode	Now: Supplying Power	
				Total Rows: 300 Page: 1/30					Total Rows: 300 Page: 1/30

Events

The **Event** log table keeps a record of changes to the state of the system to help with troubleshooting. The types of state changes that are logged include:

- Alarm states
- Configuration changes
- Battery Mode changes (for example, discharging)

To view the **Event** log, go to **Logs > Events and Alerts**.

Events are stored in a 'first in first out' (FIFO) buffer holds up to 3000 events. Of the most recent events, up to 25 can be viewed on the LCD, and up to 300 can be viewed via the web. From the web interface, all 3000 events can be exported as a .csv file.

To export an Event log go to **Logs > Events and Alerts**, and press the **Export** button at the top of the **Event** table.

Module Alerts

The **Modules Alerts** log table tracks what is happening on individual modules without interfering with **Alarms** or the **Event** log.

17.4.2. Battery Log

The **Battery** log records the duration and change in capacity (A-h) for every charge and discharge of a battery. If you have **Battery Runtime and Health** enabled, the log will also record the change in **State of Charge** (SOC) and **State of Health** (SOH).

Because of the large quantity of information that can be collected for battery charges and discharges, a complete dataset can only be obtained by exporting the log. The following three figures provide examples of the data.

When viewed on the LCD, the log shows time, activity type, duration and amp hours delivered.

When viewed on the web, the log includes the battery ID, battery capacity, state of charge, state of health and the activity results.

When exported to a .csv file, the log includes the Peukert exponent, starting and ending voltages plus the minimum, maximum and average battery currents and temperatures.

Figure 83. Battery Log on the LCD

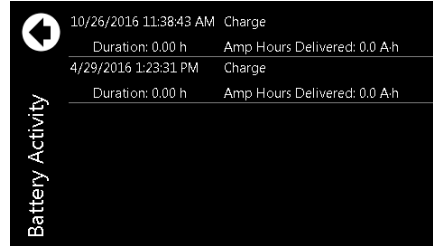

Figure 84. Battery Log on the Web

Battery Identifier	Battery Activity	Start Time	Duration (h)	Battery Capacity (A-h)	Amp Hours Delivered (A-h)	Change in SOC (%)	Starting SOH (%)	Change in SOH (%)	Battery Current - Avg (A)	Activity Results	Actions
Battery String/7887	Charge	11/2/2016 12:18:00 PM	1.58	42.0	8.6	20.7	84.2	---	5.4	Normal	
Battery String/7887	Discharge	11/2/2016 11:58:06 AM	0.34	42.0	-9.4	-26.5	85.0	-0.8	-27.2	Normal	
Battery String/7887	Charge	11/2/2016 11:54:24 AM	0.02	42.0	0.1	0.3	85.0	---	4.9	Normal	
Battery String/7887	Discharge	11/2/2016 11:54:14 AM	0.00	42.0	-0.1	-0.4	85.0	---	-34.8	Normal	
Battery String/7887	Charge	11/1/2016 1:20:10 PM	0.00	42.0	0.0	---	85.0	---	1.4	Normal	
Battery String/7887	Charge	11/1/2016 11:12:33 AM	1.86	42.0	12.2	---	85.0	---	6.5	Normal	
Battery String/7887	Discharge	11/1/2016 11:12:16 AM	0.00	42.0	-0.2	---	85.0	---	-72.0	Normal	
Battery String/7887	Charge	11/1/2016 11:10:25 AM	0.03	42.0	0.3	---	85.0	---	10.2	Interrupted by Discharge	
Battery String/7887	Discharge	11/1/2016 11:10:16 AM	0.00	42.0	0.0	---	85.0	---	0.0	Normal	
Battery String/7887	Charge	11/1/2016 11:09:28 AM	0.01	42.0	0.2	---	85.0	---	16.2	Interrupted by Discharge	

Figure 85. Battery Log in Excel

Battery Identifier	Battery Activity	Start Time	Duration (h)	Battery Estimation	Battery Capacity (A-h)	Amp Hours Delivered (A-h)	Ending Voltage (V)	Starting Voltage (V)	Change in SOC (%)	Starting SOH (%)	Change in SOH (%)	Peukert Exponent	Battery Current - Avg (A)	Battery Current - Min (A)	Battery Current - Max (A)	Battery Temperature - Min (°C)	Battery Temperature - Avg (°C)	Battery Temperature - Max (°C)	Activity Results	
Battery String/7887	Charge	11/2/2016 12:18	1.58	Enabled	42	8.6	26.7	27	73.5	20.7	84.2	---	1	1.2	5.4	37.9	25	26	26	Normal
Battery String/7887	Discharge	11/2/2016 11:58	0.34	Enabled	42	-9.4	27	24.2	100	-26.5	85	-0.8	1	-27	-27.2	-28.4	25	25	26	Normal

17.4.3. Power Outage Log

The **Power Outage** log records time and duration of every power outage to the system. If you have **Battery Runtime and Health** enabled, you can refer to the Battery log to determine the change in **State of Charge** (SOC) and **State of Health** (SOH).

When viewed on the LCD, the log shows start time, end time, and time and duration of each power outage.

When viewed on the web, the log includes the system ID, start time, end time and duration of each power outage.

When exported to a .csv file, the log includes the system ID, start time, end time and duration of each power outage.

17.4.4. Datalogs

Datalogs allows users to record measurements (**Data Signals**) at set intervals over a period of time. The **Datalog** uses the CXC HP sensors and calculated values as inputs. The controller supports up to 10 **Datalogs**, each of which may be recording up to 20 **Data Signals**.

Figure 86. Datalogs Table

Datalogs			
Add Datalog			
Name	Status	Sample Count	Actions
Battery Datalog (Datalog/5092)	Waiting	602	Remove Edit
Temperatures (Datalog/1280)	Sampling	297	Remove Edit

The interval between samples can be configured, as well as the number of samples collected. When the maximum number of samples have been collected, the newest sample replaces the oldest sample. Data capture can either be started and run continuously or an equation can be used to control data capture.

Datalogs are saved to the file system when the controller is reset by a user, as well as being automatically saved once every day. If power is lost to the controller, there is potential for some data loss.

Figure 87. Datalog Window: Status, Signals, Configuration and Preview Chart

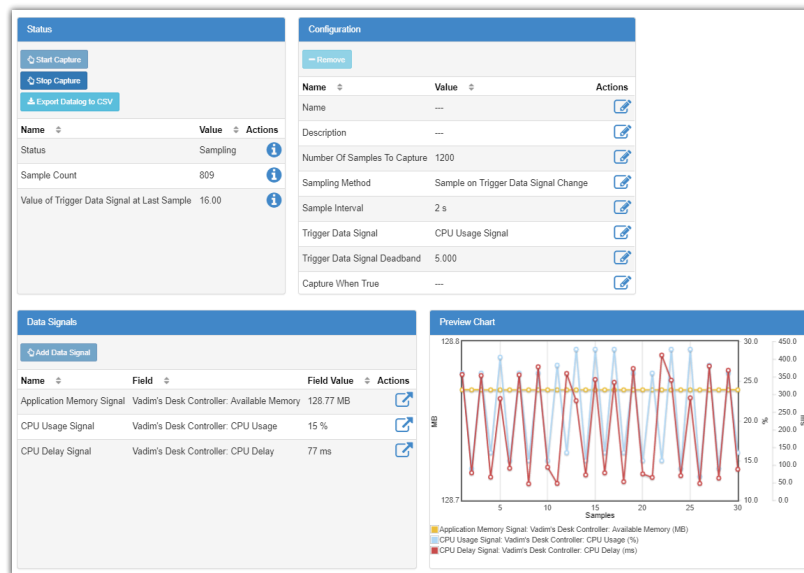

If any **Data Signals** are not configured, a **Datalog** will not start.

If there is a **Clock Error Alarm**—which means that the date has not been set, a **Datalog** will not start.

If a **Datalog** is running and a controller reset occurs, the **Datalog** will try to resume data collection on controller startup.

If there is data available, a **Preview Chart** displays up to 30 samples. If there are more than five **Data Signals**, only the first five signals are displayed in the preview. If a value is unknown, it is displayed on the preview as a zero value.

17.4.4.1. Create a Datalog

There are three stages to setting up a **Datalog**:

- Add a **Datalog**
- Add the **Data Signals**
- Run the **Start Capture** command

To create a **Datalog**:

1. Go to **Logs > Datalogs** and click **Add Datalog**.

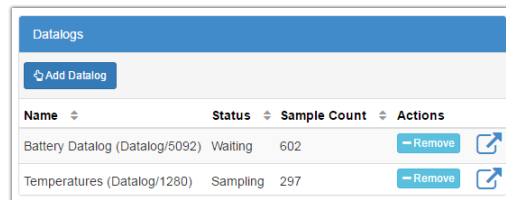

Up to 10 datalogs can be created.

2. Click the more details icon of the new **Datalog**.

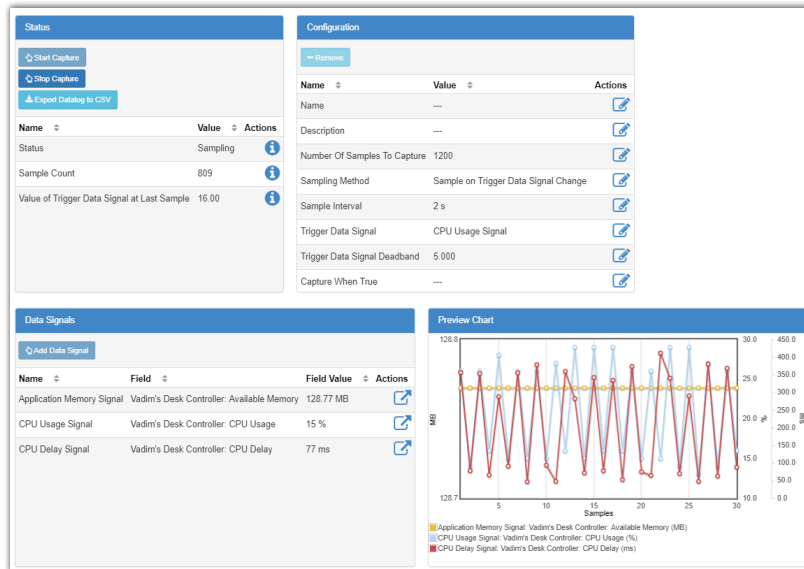

3. From the **Configuration** table, click the edit icon to setup the following information:

- a. **Name** to give the Datalog a name;
- b. **Description** to describe the purpose or usage of the Datalog;
- c. **Number Of Samples To Capture** from 60 to 3600 samples;
- d. **Sampling Method:**

Datalogs can be configured to either **Sample at Fixed Time Intervals**, or **Sample on Trigger Data Signal Change** in which case a new sample of all Data Signals will be taken only when the **Trigger Data Signal** changes by more than the **Trigger Data Signal Deadband** compared to its value when the previous sample was taken.

- e. **Sample Interval** to set the interval from 2 seconds to 3 hours (10800 seconds).
- f. **Trigger Data Signal** is the Data Signal which triggers sampling, when the Sampling Method is set to Sample on Trigger Data Signal Change
- g. **Trigger Data Signal Deadband** determines how much the **Trigger Data Signal** has to change before a new sample is taken.
- h. **Capture When True** to control whether data is captured continuously or only under certain conditions.

If the **Capture When True** value goes unknown, the Datalog will ignore it. If the Datalog is in the waiting state (or the sampling state), when the **Capture When True** value goes unknown, the Datalog will stay in the waiting (or sampling) state it was already in.

4. From the **Data Signals** table, click **Add Data Signal** to add the number of data signals you need.

Up to 20 signals can be created.

5. From the **Configuration** table, click the edit icon to setup the following information for each **Data Signal**:

- a. **Name** to give the signal a name;
- b. **Description** if you want to document what the signal means or how its value should be interpreted;
- c. **Field** to bring up the field picker and select the ADIO input or other value you want to monitor.

You cannot leave data signal fields unknown. You cannot select state or boolean values for data signals.

6. Run the **Start Capture** command.

If all of the **Data Signals** are not configured when the Start Capture button is pressed, the capture will still start, but an entry is made in the event log to indicate a Data Signal is not configured.

You can configure the **Datalog** to run at certain times of day, or to stop after a certain time or number of samples, by configuring a boolean **Custom Data** and then configuring **Capture When True** to use it.

If you change the **Data Signals**, **Sampling Method**, **Trigger Data Signal**, **Trigger Data Signal Deadband** or **Number Of Samples To Capture**, that will make the old data is incompatible with the new data. The old data will be deleted when you run the **Start Capture** command.

17.4.4.2. Transferring Datalogs Configuration to other Controllers

By importing and exporting a configuration file, some datalogs configuration can be transferred to a new controller. A datalog sources information from data signals coming from various physical measurements on its system, and the data signal will only transfer to a new controller if that measurement also exists on the new system.

For example, the Total Load Current is an attribute of the DC System. A datalog measuring the Total Load Current will only transfer to the new controller if it has a DC System in its inventory.

However, signals such as a rectifier's Ambient Temperature measurement are attributes of that specific rectifier. If a configuration file is exported from one controller and imported onto another, the Ambient Temperature data signal will not import, and it will raise an **Invalid Config Ignored** event. The new rectifier will need to be re-configured to the new controller.

17.4.5. Performance Logs

The **Performance Log** holds up to one-year's worth of daily roll-ups with a minimum, maximum and average value for key usage statistics. For systems, this includes: input voltage and current, and the output voltage and current. For the controller, the CPU and memory usage are tracked.

Figure 88. CPU Memory in Use Performance Log

To create the daily roll-ups, the **Performance Log** is rolling up second data into minute data, minute data into hour data and hour data into daily data. The web displays previews of all four sets of data as they are collected. In these previews, the horizontal axis shows the data sampled, not the time stamp. Daily statistics with minimum, maximum, and average values can be exported for each log by clicking the **Export data to CSV** button under the **Days** graph. Or you can export every log by clicking **Export All** via **Logs > Performance Logs**.

If the controller is shut down for some period of time, the preview window will not show the gap in time.

If there is a clock error, indicating that the time and date is unknown, a **Performance Log** will not collect data.

Note: The performance log for the **DC System Total Output Current** has an additional table **Top Hourly Averages** that shows the top-three hourly averages and timestamps for the system total output current. This table does not exist on any other performance log.

17.5. File Maintenance

This section of the manual covers the following:

- Using file preferences to name files
- Upgrading the controller operating system via the LCD

- Upgrading the controller software
- Configuration restore points
- Importing and exporting configuration files
- Exporting diagnostic information
- Importing and exporting license keys
- Exporting a snapshot of controller and system status

17.5.1. File Preferences

If working with multiple systems, use the file naming options to keep your files organized. You can add the controller name and/or the date to exported and saved files.



If adding a date, the date string format is YYYY-MM-DD making it easy to sort in file browsers.

If adding the controller name, and that name contains whitespace, illegal characters for file names or some extended characters, those characters will be removed from the string that is added to the filename. This naming convention applies to most files that can be saved or exported from the controller for example: configuration files, log files, licensing files and backup files.

To append a name and/or date:

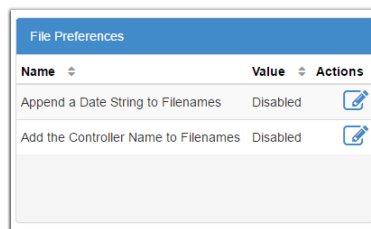
1. Go to **Controller > Configure Controller > User Interface Preferences.**



Name	Value	Actions
Append a Date String to Filenames	Disabled	
Add the Controller Name to Filenames	Disabled	

2. In the **File Preferences** table,
 - click the edit icon in the **Append a Date String to Filenames** field to enable the add date to filenames.
 - click the edit icon in the **Change the Add the Controller Name to Filenames** field to add the controller name to filenames.

17.5.2. File Maintenance via the LCD

To enable more to be done with the LCD screen and USB mass storage devices, most of the file maintenance functions available via the web are also available via the LCD. LCD file operations take place using the top-level or root directory of a FAT32 formatted USB drive.

File operations that are available on both the web and LCD are as follows:

- **Import** and **Export** of configuration files
- **Upgrade** of the controller application software
- **Upgrade** of the controller operating system software

- **Import** and **Export** of license key files
- **Upgrade** of module application software using ACAN files
- **Downloading** of event logs and module alerts

File operations that are available only via the LCD:

- **Backup** and **Restore** of the controller application software and configuration

File operations that are available only via the Web:

- **Downloading** of performance logs, datalogs and tables

17.5.2.1. LCD Import and Export

On the LCD, go to **Menu > Controller > Advanced Functions > Configuration File**. The **Export Controller Clone** command allows you to export the entire controller configuration to a connected USB drive. The other options **Export System or ADIO** and **Export Partial** are not supported on the LCD. The **Import** command allow you to import configuration files with limitations as noted below.

Alternatively, go to **Shortcuts > Browse USB**. Here you can select a configuration file to perform an **Import**.

Note:

*Using the **Import** command from the LCD has limitations. Importing a configuration file that is a clone of a controller will always work. However, importing a configuration file that is for a system, an ADIO or a partial configuration will only work if the import can be achieved unambiguously. For example, if the import is intended to change some configuration for an ADIO, but there are more than one ADIO of the same type it will be ambiguous as to which ADIO should receive the configuration. Therefore the import will fail. In this scenario, the web should be used to do the import so that the user can choose which ADIO should receive the configuration.*

17.5.2.2. LCD Application Upgrade

There are two ways to upgrade the controller software:

1. On the LCD, go to **Menu > Controller > Advanced Functions > Controller Software Upgrade**. The **Upgrade New Controller Software and Reboot** command will allow you to upgrade the application using an appropriate upgrade (zip) file.
2. On the LCD go to **Shortcuts > Browse USB**. You can upgrade the controller application via an appropriate upgrade (zip) file that has been stored on a USB drive.

The application upgrade takes several seconds. The controller reboots automatically when complete.

17.5.2.3. Operating System Upgrade

On the LCD, go to **Shortcuts > Browse USB**. You can upgrade the controller operating system via an appropriate upgrade (zip) file that has been stored on a USB drive.

Note:

*There must be at least 33 MB of free space to run the Operating System upgrade. To check the available Free Space, goto **Menu > Controller > Configure Controller > Storage and Memory > Application Storage**.*

The operating system upgrade takes several minutes. The controller reboots automatically when the upgrade completes.

17.5.2.4. Backup and Restore

The **Backup** command allows you to make a full backup of a system so that you can Restore it after. You can access the **Backup** function via the LCD in **Shortcuts > Backup**. The Backup functions will make a copy of both the application software and the configuration information for that version of the application in a single back up file. This includes controller-specific information such as IP addresses, user names and passwords.

A **Scheduled Action** can be configured to automatically back up the controller to a USB drive at configurable intervals. This can be configured in **Controller > Advanced Functions > Advanced Functions > Scheduler**.

If you make a **Backup** of the factory default settings, then you can report the factory defaults. If you make a backup of the fully commissioned working system then you can restore the system to that state.

The **Restore** functions allow you to take an existing backup file and restore the contents of that file to the system. All existing application software and configuration information will be deleted and replaced by the contents of the backup file. You can access the Restore function from the LCD in the **Shortcuts > Restore**.

Backup and **Restore** are meant to be used to recover from server errors. If a controller was damaged and needed to be replaced you could use the backup file to restore a new controller to the same settings as the previous controller.

17.5.3. Upgrading the Controller Software

To perform a controller software upgrade:

1. Go to **Controller > Advanced Functions**.
2. Click **Software Upgrade**.
3. Click the **Upload New Controller Software and Reboot** button.
4. From the Upload File window, click **Select File**, and then select the upgrade file.

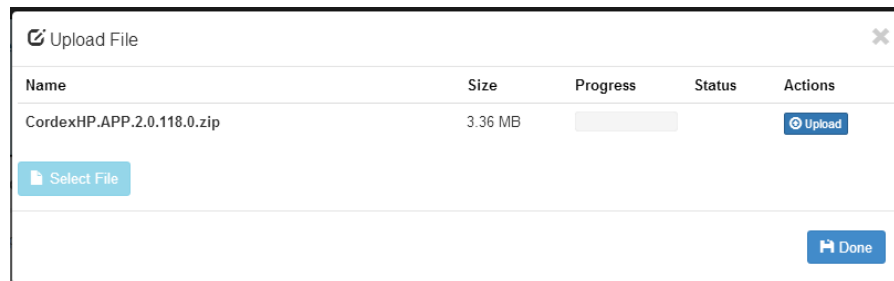

5. Select the controller upgrade .azp file.
6. After the upgrade is finished, the controller resets automatically.

Once complete, the **Login** page displays and you must log back in to the controller.

After an upgrade, it is common to see a number of Event Log entries showing configuration fields being set. This is normal on an upgrade when the system needs to set up new features or options that have been added.

17.5.4. Exporting Configuration

There are three options when exporting a configuration file.

Export Controller Clone: is used to transfer the entire configuration. A common use for this type of export is to make a back-up of the current settings. When using this export, almost all information is saved to the exported file. See the note below for an explanation of what is not included in the export file.

Export System or ADIO: is a way to copy a system or an ADIO to another controller. Only a single system or an ADIO may be selected. If selecting system, any ADIO referenced by that system is also exported. For example, if an L-ADIO is used for voltage measurements and 6I-ADIO is used for shunt measurements they are saved to the export file.

Export Partial: is used to select a specific set of information for export. This is commonly used for transferring user alarms, custom data, alarm thresholds or other configured data that may need to be common between controllers. A partial export must be performed on a set of related configurations. The wizard allows you to select either a controller, a system or an ADIO. After the selection is made, all associated configurations are presented in a list and are exported by selecting the check-box. For example: to export a set of custom data, select controller; to export a set of DC System alarm configurations, select the required system from the drop-down list. If any of the selected configuration references an ADIO, that ADIO is also exported.

Some items must be exported as a whole. This includes items that can be created and removed by a user (other than systems) or items that are permanent to the controller. For example if selecting:

- controller: you can export a whole SNMP destination, but not a particular configuration within a destination; or if exporting custom data, you can export a whole custom data with all its variables, but

not a specific variable defined within the custom data. The same applies to user alarms, datalogs, schedules.

- DC system: you can export a whole load, shunt or disconnect, but not the configuration within these items.

 **Note:** *Some configuration can never be exported:*

- *Controller description and location information (this is unique to each controller)*
- *IP configuration (to avoid loss of Ethernet connectivity)*
- *Web server port configuration (to avoid loss of Ethernet connectivity)*
- *Line power channels (unique to line power modules)*
- *Power module (power modules are unique to a system)*
- *Users (to maintain password security)*
- *Server passwords (e.g. email server password; to maintain password security)*

To export settings:

1. From the main dashboard go to, **Controller > Advanced Functions > Configuration File**.
2. Click the type of export required:
 - **Export Controller Clone:** a file is generated and uploaded to your browser.
 - **Export System or ADIO:** A wizard displays in which you can select a System or an ADIO. Select an item to export and then click **Next**. Use the **Download File** option to save your export file.
 - **Export Partial:** A wizard displays in which you can select a configuration source, click **Next**. In the **Select Configuration to Export** window, select each configuration item for export, click **Next**. Review the items from your selected configuration and use the **Download File** option to save your export file.
3. To help distinguish among configuration files rename your export file with a unique identifier. This can be important when making a back-up files for archiving or if a controller replacement is required.

17.5.5. Importing Configuration

When importing a configuration file, the controller will analyze the file to determine the type of import to perform. There are three types of import corresponding to the three types of export.

Clone

Clone is performed when a file that has been exported using **Export Clone Controller** is uploaded. The configuration of the controller is matched to that contained in the file. In addition all existing systems, custom data, timers, counters, datalogs are removed. Clone is also performed if a configuration file from a version previous to v4.00 is uploaded.

Copy System or ADIO

Copy system or ADIO is performed when a file that has been exported using **Export System or ADIO** is uploaded. The system or ADIO contained in the file is added to the controller. If a system is being

imported, the new system is created and added to the controller under the **System** menu. If importing a DC System and a DC System already exists the import will fail because only one DC System is supported. It is necessary to first delete the existing DC System before doing the import. This also applies to Converter Systems. All other types of systems do not have this limitation. If importing an ADIO, the ADIO is added under the **Modules** page. After importing the ADIO, use the **Replace ADIO** command to transfer the configuration of the imported ADIO to an existing ADIO.

Partial Import

Partial import is performed when a file that has been exported using **Export Partial** is uploaded. The configuration contained in the file replaces that of any matching existing configuration settings. It is possible that the destination of the imported configuration cannot be automatically determined. For example, if configuration for a Line System is imported and there exists more than one Line System, the user will be required to select the which system should receive the configuration. Partial Import can also be used to transfer custom data, counters and timers from one controller to another.

Importing may not always be fully successful. Configuration values that point to another value, such as 'source' values that point to voltage, current or temperature, may not exist or may be ambiguous. If this is the case, the value is ignored and an entry is made in the event log. It is then necessary to remap the source field to a valid value.

 **Note:** *Some configuration can never be exported:*

- *Controller description and location information (this is unique to each controller)*
- *IP configuration (to avoid loss of Ethernet connectivity)*
- *Web server port configuration (to avoid loss of Ethernet connectivity)*
- *Line power channels (unique to line power modules)*
- *Power module (power modules are unique to a system)*
- *Users (to maintain password security)*
- *Server passwords (e.g. email server password; to maintain password security)*

To import settings:

1. From the main dashboard go to, **Controller > Advanced Functions > Configuration File**.
2. Click the **Import** button, select a file to import and click the **Upload** button.
3. If the configuration cannot be imported without ambiguity, there will be a drop-down list to select the destination system or ADIO. This only happens if trying to do a partial import. Select the destination system and click **Next**.
4. A page displaying an **Import Summary** is shown. Review the summary and click **Next** to import. If the summary looks incorrect, you can close the wizard and try **Import** again to select another file.
5. Perform **Replace ADIO** if required. When this operation is done, the controller gives special attention to the status of relays mapped to a disconnect. If, as a result of the replace operation, a disconnect relay will be shared with an alarm relay or if the state of a disconnect relay will change because of a change to the relay polarity, the replace will fail and an entry made in the event log identifying the alarm relay was causing the failure.

17.5.5.1. Importing a System

It is common to create a system on the controller that has been already configured on a different controller. This can be done by first exporting a configuration file from the already configured controller, then importing it. When exporting, choose the appropriate export method, either clone or copy, as previously described.

To import a system in a configuration file:

1. Go to **Controller > Advanced Functions > Configuration File**.
2. Press the **Import** button to launch the import wizard.
3. Use **Select File** to browse to the configuration file on your local computer (e.g. `exportconfig.xml`).
4. Click **Upload** to upload the file to the controller.
5. Review the **Import Summary** page. This shows a summary of what you are about to import. If it is not correct, close the wizard and start over to select a different configuration file.
6. Press **Next**, and then wait for the import to complete. If the import fails or encounters an error an error message is displayed.
7. Perform **Replace ADIO**, if necessary. If the imported system referenced one or more ADIOs the import included these ADIOs, and they now show up as **Comms Lost**. You should replace these **Comms Lost** ADIOs with existing ADIOs of the same type via the **Modules** page.

The system has been imported and configured to use the existing ADIO.

17.5.6. Configuration Restore Points

The Configuration Restore Point feature will automatically capture the configuration of the controller daily (if anything has changed), providing automatic backups that can be used in situations where changes may have been made by mistake. This feature also enables you to:

- Create a configuration restore point manually. This can be useful to keep a backup before a big configuration change, or to create a known good configuration that can be restored to at a later point.
- Restore to a configuration restore point. This will restore the configuration of the controller to the configuration it had when the configuration restore point was created.

Configuration restore points can be found by going to **Controller > Advanced Functions > Configuration File**. On this page there are two tables related to configuration restore points:

- **Configuration Restore Point Information:** This table provides general information about how the feature works, such as how many restore points will be kept, the frequency they are created, and which restore points will be deleted if the maximum is reached.
- **Configuration Restore Points:** This table provides information about the actual restore points. Each row represents a restore point, and provides information about when it was created, a user-defined description, and if the specific restore point can be deleted or not.

 **Note:** *These restore points only keep a copy of the configuration of the controller, not the software application. It is possible that restoring to a restore point from an older software version could cause unexpected behavior. Please read the warnings and help in the wizard to ensure the restore will restore what is expected.*

17.5.6.1. Creating Configuration Restore Points

Configuration restore points will be created daily (if any configuration changes have been made). It is also possible to manually create a restore point. To manually create a configuration restore point:

1. Go to **Controller > Advanced Functions > Configuration File**.
2. On the **Configuration Restore Points** table, click **Create Configuration Restore Point**.
3. Read the **Preview**, then click **Next**.
4. Enter in a **Description** and specify the **Deletion Policy** for this restore point, then click **Next**.

 **Note:** *A maximum of five restore points can be marked as **Never Delete**. This should be used to ensure important restore points will never get deleted when daily restore points are created.*

5. Review the data you entered in, then click **Next**.

A new configuration restore point has now been created, and can be used to restore a configuration of the controller if necessary.

17.5.6.2. Restoring to a Configuration Restore Point

If a configuration was changed by mistake, it is possible to undo those changes by restoring to a configuration restore point. To restore to a configuration restore point:

1. Go to **Controller > Advanced Functions > Configuration File**.
2. In the **Configuration Restore Points** table, click the details arrow beside the restore point you wish to restore to.
3. On the details page of the restore point, click **Restore Configuration To This Point**.
4. There will be three tables shown: **Items To Be Added**, **Items To Be Removed**, and **Configuration Changes**. These tables explain the changes you will see if the controller configuration is restored to this restore point. After reading through and ensuring these changes are desired, click **Next**.

 **Note:** *Before the configuration is restored, a new restore point will be created. This will allow you to restore back to the current configuration if necessary.*

5. If restoring will cause anything to be removed from the controller, another step will appear warning that these items will be removed. To proceed with the restore, enter **confirm** into the text box, then click **Next**.

After a short period of time, the wizard will display that the configuration has been restored.

17.5.7. Exporting Diagnostic Information

! ***Important:** To facilitate any support request, export a diagnostic information package before contacting Alpha Technologies.*

Exporting a diagnostic information package helps Alpha provide assistance with any issues you may experience. This information package is an archive that contains the following:

- Controller clone
- Device Log
- Event Log
- Battery Log
- Daily statistics for all Performance Logs
- Datalogs

Additionally, if any T2S modules for the AMPS HP2 system are acquired, an additional step will be available in the **Export Diagnostic Information** wizard to include their logs and configuration files in this package.

17.5.7.1. To Export a Diagnostic Information Package

This package can be obtained in the following ways, via the LCD or via the web.

1. From the dashboard of the LCD, go to **Shortcuts > Export Diagnostic Information** to launch a wizard that will generate save the package to a USB drive.
2. From the web click on the **Accounts and Shortcuts > Export Diagnostic Information** on the top bar to launch a wizard that will generate the file and let you download the file to your computer.

17.5.8. Licensing

Some features and functions on the CXC HP require a separate license key. Most controllers have the correct license keys installed at the factory. If a controller is purchased as a spare or is being re-purposed from a different type of system, it may be necessary to update the license key.

License key operations available on both the web and LCD are as follows:

- **Import** and **Export** of license key files
- **Enable** and **Disable** a temporary license

17.5.8.1. Export a License Key File

To update the license key on a controller, the first step is to export the current license key, and then send it to the company from which your system was purchased.

To export a license key:

1. From the main dashboard, go to **Controller > Advanced Functions > Licenses**.

2. Click the **Export License Key File** button.

From the web, this downloads a licenses.txt file to your downloads folder. From the LCD, this saves a licenses.txt file on your USB drive.

17.5.8.2. Import a License Key File

Once you have an updated license key file you can import it into your system and enable the new license.

To import a license key:

1. From the main dashboard, go to **Controller > Advanced Functions > Licenses**.
2. Click the **Import License Key File** button. From the web, you are prompted to locate the file (e.g. licenses.txt) and upload to the controller. From the LCD, select from the *.txt files on your USB drive.

There are three possible results depending on the license key file imported.

<p>The license key file is valid and raises the level of at least one license key</p>	<p>Three things should happen:</p> <ol style="list-style-type: none"> 1. The Value or level of at least one license key in the Licenses table should change. You can check the event log to confirm which values changed. 2. If a temporary license was enabled, that temporary license is now disabled. This prevents the temporary license from expiring after a permanent license key has been uploaded. 3. If there were licensing alarms, they should have cleared.
<p>The license key file is valid but does not raise the level of any license keys</p>	<p>No errors will be generated but no license key values will be changed either. It is not possible to downgrade a license key. Any license keys that are less than or equal to the current license key will be ignored.</p>
<p>The license key file is not valid, is corrupt or is for a different controller</p>	<p>An error message states that the licensing information is not valid for this controller and the file will be ignored. Look at the text of the licensing file, and ensure that the first line matches your controller ID.</p>

Figure 89. The Licensing Page

Controller / Advanced Functions / Licenses

Licenses

Import License Key File

Export License Key File

Name	Value	Actions
Controller ID	CXCP-Y9TT-NCGB-ACFU	i
Cordex HP Base	Enabled	i
AMPS HP2	Disabled	i

Temporary License

Enable Temporary License

Disable Temporary License

Name	Value	Actions
Status	Disabled	i
Time Remaining	31 d	i

Alarms

Name	Status	Limit	Priority	Relay	Actions
Temporary License In Use	Inactive		Minor	---	Test Alarm ↗
Temporary License Expired	Inactive		Minor	---	Test Alarm ↗
Required Feature License Missing	Inactive		Major	---	Test Alarm ↗

17.5.8.3. Temporary License

It is possible to enable a temporary license that will enable all licenses on the system for one month in total. This is intended to be used in situations where it is not possible or convenient to wait for a permanent license to be sent. You can enable the temporary license, get everything up and running, and then request the permanent license at some later time. The time remaining on the Temporary License will count down from 31 days and it can not be easily reset.

To enable/disable a temporary license:

1. From the main dashboard, go to **Controller > Advanced Functions > Licenses**.
2. Click the **Enable Temporary License** button.

As long as the time remaining is not zero, the **Temporary License Status** value changes to enabled.

The time remaining counts down the number of days remaining.

3. Click the **Disable Temporary License** button.

The **Temporary License Status** value changes to disabled.

The time remaining shows the number of days remaining.

17.5.9. Uploading the Software Manual

The CXC HP software manual can be uploaded to the controller so it is directly accessible via the web interface. The controller can only contain one version of the software manual at a time.

To upload the user manual:

1. Go to www.alpha.ca, and then download the HTML version of the software manual for controller upload.
2. Go to **Controller > Advanced Functions > Software Manual**.
3. Click **Upload Software Manual**, and then select a file to import.
4. Click **Upload**. It takes several minutes for the file to upload and install. When the upload is complete, a notification is displayed.
5. Click **Account and Shortcuts** drop-down menu on the top right-side of the browser window to confirm that the file is installed.
6. Click the **Software Manual** entry at the top of the list. A new browser tab should open with the software manual. If not, try refreshing the browser using F5 on your keyboard.

A navigation and search pane opens on the left-side of the browser window. Use this to search for content. If required, it is also possible to print pages from this pane.

17.5.10. Exporting Inventory

A common system maintenance activity is to gather, record and archive a set of data about the controller and systems. This can be a tedious process depending on the amount of data required. To facilitate this the CXC HP controller provides a set of data, both live status data and configuration, as a downloadable file. This file contains most of the information that is viewable from the LCD and WEB UI and serves as a snapshot of the present state of the controller.

To download this file:

1. If using a controller with the LCD or OLED display, insert a USB drive.
2. Go to the menu location to find the download button:
 - a. On the LCD, go to **Maintenance** and scroll down to the **Export Inventory to CSV** button and press it.
 - b. On the WEB, go to **Controller > Inventory** and press the **Export Inventory to CSV** button in the **Inventory** table.
 - c. On the in-shelf controller with the OLED display, press the **Menu** button and scroll down to **ExplInv** and press the **Menu** button again.
3. Press the **Export** button to initiate the download.

Once started, the file is downloaded to the USB drive or PC depending on where the export was initiated from. If initiated from the LCD or OLED display it is downloaded to the USB drive. If initiated from the WEB it is downloaded to the PC. Depending on the amount of data to download, it may take several minutes to complete.

This file can now be opened in a spreadsheet program for analysis.

 **Note:** Sensitive data related to users and user permissions, passwords, and licensing is not included in the exported file.

17.6. User Account Maintenance

17.6.1. Setting Up Users and Permissions

 **Note:** *These features are only available to those with Administrator or Account Manager privileges.*

By default the CXC HP has seven user accounts: one administrator, one account manager and five operators. The Name field in these accounts is not editable. User accounts cannot be added or deleted, but they can be enabled or disabled.

Within the **Users and Security** menu you can use the **User Roles** drop-down menu to configure what privileges each user has when accessing the system or changing passwords.

This section of the manual covers the following:

- Editing user permissions
- Enabling new users
- Disabling users

17.6.2. Editing User Permissions

These features are only available to those with Administrator or Account Manager privileges.

To edit user permissions:

1. Go to **Controller > Configure Controller > Users and Security**.
2. From the **User** table, click the see more details icon on the line of user whose access must be changed.
3. On the right-side of the User Role line, click the edit icon.
4. From the drop-down menu, set the **User Role** and click **Save**.

17.6.3. Enabling New Users

Within the **Users and Security** menu you can enable, edit and disable users. Only users with Administrator or Account Manager privileges can enable users. Within the **User Roles** drop-down menu you can configure the privileges each user has as well as create passwords. The different levels of user permissions are as follows:

- Administrator - Can modify all configurations, perform any actions with the exception of factory information
- Account Manager - Can only create and modify user accounts
- Operator - Can modify all configurations, can change their own password
- Restricted Operator - Can modify configuration values, but cannot add or remove systems or inventory, can change their own password
- Guest - Can read any field, but can not configure any settings

To enable a user:

1. Go to **Controller > Configure Controller > Users and Security**.
2. From the **User** table, click the see more details icon on the operator1 line.

Users and Security					Active User Sessions				
Name	Description	Alias	User Role	Actions	Name	User Role	Client	Address	Actions
admin	---	---	Administrator		admin	Administrator	Web	10.1.8.163	
accounts	---	---	Account Manager		admin	Administrator	Web	10.1.8.135	
operator1	Technician Level 1	TL1	Operator						
operator2	---	---	Guest						
operator3	---	---	Guest						
operator4	---	---	Guest						
operator5	---	---	Guest						

3. Optional: Edit the **Description** and click **Save**.

operator1

Name	Value	Actions
Description	Technician Level 1	
Alias	TL1	
User Role	Operator	

4. Optional: Edit the **Alias** and click **Save**.



The alias field allows login names that a user is more familiar with. For example, if you set the `operator1` alias to `TL1`, you can login to the `operator1` account using the `TL1` user name.

5. Set the **User Role** (permissions) and click **Save**.

The screenshot shows a 'Field Details' dialog box. At the top, there is a close button (X). Below it, the 'User Role' section has a dropdown menu currently set to 'Guest'. The dropdown is open, showing the following options: 'Guest', 'No Access', 'Guest', 'Operator' (highlighted in blue), 'Account Manager', and 'Administrator'. Below the dropdown, there is a blue help box with a question mark icon and the text: 'Help. This sets the configuration privilege rights of the user.' At the bottom right, there are two buttons: 'Cancel' and 'Save'.

6. From the operator1 table, click **Change User Password** to set the password and click **Save**.

The screenshot shows a 'Change Password' dialog box. It has a close button (X) at the top right. Below the title, there are three input fields labeled 'Your Password', 'New Password', and 'Confirm Password'. At the bottom right, there are two buttons: 'Cancel' and 'Save'.

7. Login using the updated password or permissions.

17.6.4. Disabling Users

These features are only available to those with Administrator or Account Manager privileges. User accounts are not actually deleted, they are edited to remove a user's access to the system.

To disable users:

1. Go to **Controller > Configure Controller > Users and Security**.
2. From the **User** table, click the more details icon on the line of user whose access must be changed.
3. On the right-side of the **User Role** line, click the edit icon.
4. From the drop-down menu, set the User Role to **No Access**.

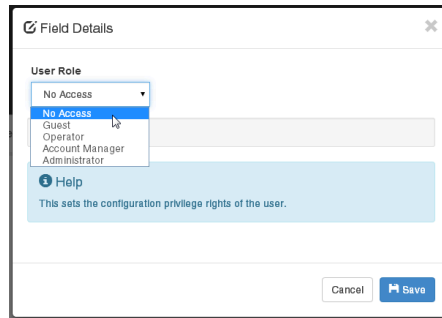

5. Click **Save**.

17.6.5. Changing the Default Password - LCD

This section describes how to change user passwords from the LCD.

You must be logged in to the controller to change passwords.

To change the default password:

1. From the main Dashboard, click the **Menu** button.
2. Press **Controller** to highlight it, and then press the arrow on the right-side.
3. Press to highlight **Configure Controller**, and then press the arrow on the right-side.
4. Swipe with an upward motion on the touch screen to scroll down to **Users and Security**, and press to highlight.
5. Press the arrow on the right-side, and then select **admin**.
6. Press **Change User Password**.
7. Press the **Execute** button to modify the default, and then click the checkmark to save your changes.

17.6.6. Changing the Default Password - Web

This section describes how to change the default password via the web interface.

To change the default password via the web:

1. From the main dashboard, go to **Controller > Configure Controller > Users and Security**.



2. From the **admin** line, click the **more details** icon on the right-side of the table.
3. From the table, click the **Change User Password** button.

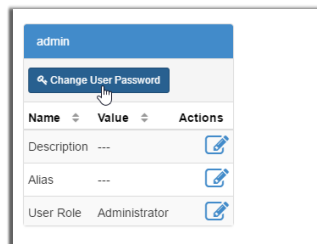

4. Enter a new password and then click **Save**.

17.6.7. Remote Configuration Lockout

The Remote Configuration Lockout feature allows for a complete lockout of configuration changes from the Web UI. When this feature is active, no user, regardless of permission level, will be able to change or modify the configuration via the Web UI. Configuration changes will still be possible via the LCD.

To enable this feature:

1. On the LCD, go to **Maintenance > Remote Configuration Lockout**.
2. Click the edit icon beside **Remove Configuration Lockout**, change the value to **Disabled** (logging in if required), then save.
3. Click the edit icon beside **Lockout Override Time**, enter in the desired time to override the lockout (more on the override below), then save.

After Remote Configuration Lockout is enabled, no configuration changes will be allowed from the Web UI.

17.6.7.1. Overriding the Remote Configuration Lockout (LCD)

After Remote Configuration Lockout has been enabled, it is possible to override the lockout for a user-specified amount of time. This will allow a technician on-site to override the lockout temporarily to allow for a user off-site to perform some configuration via the Web UI.

To override the configuration lockout from the LCD:

1. On the LCD, go to **Maintenance > Remote Configuration Lockout**.
2. Click **Override Remote Configuration Lockout**, then click **Execute**.

The configuration lockout will be overridden for the amount of time that has been configured. The time remaining in the override can be seen via **Lockout Override Time Remaining**.

17.6.7.2. Overriding the Remote Configuration Lockout (OLED)

To override the configuration lockout from the OLED:

1. On the OLED, go to the menu by clicking the **Select** button.
2. Scroll down and click the **RemCfg** button.

You will be shown a “Lockout Overridden” success confirmation message, and the configuration lockout will be overridden for the amount of time that has been configured.

17.7. Remote Authentication

The CXC-HP is configured with local user accounts by default, where login credentials are verified against encrypted data on the CXC-HP. Remote authentication provides an additional ability to verify login credentials from a remote server. This can be an advantage from a network security standpoint, as login credentials can be updated from one central server rather than being updated individually on each controller. Enabling Remote authentication has no effect on the already configured default user accounts stored locally on the CXC-HP.

The CXC-HP supports credential caching. In the case that the CXC-HP is not able to contact the specified remote server, the CXC-HP will verify the user’s credentials against the last 10 authenticated credentials encrypted and stored locally on the device.

The CXC-HP can support remote authentication through either the RADIUS or TACACS+ protocol.

 **Note:** Login access to the default user accounts are unaffected when a remote authentication server is inaccessible.

 **Note:**

- Remote Authentication passwords are limited to 32 characters. Shared Secrets and Secret Keys are limited to 52 characters.
- The User Roles Configuration fields are case-sensitive when matched against the values stored on the remote server.

17.7.1. RADIUS Authentication

Remote Authentication Dial-In User Service (RADIUS) is a client/server protocol and software that enables clients to communicate with a central server to authenticate and authorize their access to the requested system or service. This section of the manual describes RADIUS Authentication, its features, and how to setup the controller as a RADIUS client.

 **Note:** See your RADIUS server documents for any detailed information on setting up the RADIUS server.

17.7.1.1. Using RADIUS Authentication

The CXC HP controller can be configured to use a RADIUS server to remotely authenticate users. In this case the controller is acting as a RADIUS client. A RADIUS server, such as FreeRADIUS, must be configured separately for remote authentication to work correctly.

 **Note:** See your RADIUS server documentation for information about setting up the RADIUS server.

The following are features for using RADIUS authentication.

- **Encryption Protocol:** provides encrypted Password Authentication Protocol (PAP) or Challenge-Handshake Authentication Protocol (CHAP).
- **Encrypted RADIUS Shared Secret:** provides a securely encrypted, shared secret authentication on the RADIUS server.
- **Test RADIUS Server Settings:** provides an authentication request to test the RADIUS server settings.
- **Network:** Operates on the User Datagram Protocol (UDP)

How RADIUS Authentication Works

When the **Remote Authentication Type** field is set to **RADIUS (TACACS+ is disabled)** on the controller, the user credentials are encrypted, and an authentication request is sent to the RADIUS Server. When the **Remote Authentication Type** field is set to **None (RADIUS and TACACS+ are disabled)**, only local user accounts can login.

When a RADIUS response is received from the RADIUS server it contains the user's **Group Attribute Value**. If the user's **Group Attribute Value** matches one of the assigned user roles, the matching user privilege is granted. If there are no matches, the user is denied access. Upon a successful login, the encrypted user credentials are saved in the controller's cache. This can be used if there is a situation where the RADIUS Server is unavailable.

Figure 90. RADIUS Configuration Table

Name	Value	Actions
Remote Authentication Type	None (RADIUS and TACACS+ are disabled)	[Edit]
RADIUS Authentication Server Address	---	[Edit]
RADIUS Authentication Server Port	1812	[Edit]
RADIUS Timeout	3 s	[Edit]
RADIUS Encryption Protocol	PAP	[Edit]
RADIUS Server Shared Secret	---	[Info]

Name	Value	Actions
Group Attribute ID	11	[Edit]
Group Attribute Value for Admin User Role	---	[Edit]
Group Attribute Value for Accounts User Role	---	[Edit]
Group Attribute Value for Operator User Role	---	[Edit]
Group Attribute Value for Restricted Operator User Role	---	[Edit]
Group Attribute Value for Guest User Role	---	[Edit]

- **Remote Authentication Type:** when set to **RADIUS (TACACS+ is disabled)**, users are allowed to be authenticated by a RADIUS server.
- **RADIUS Authentication Server Address:** the DNS name or the IP address for the RADIUS server.
- **RADIUS Authentication Server Port:** the default port is 1812.
- **RADIUS Timeout:** the time, in seconds, that the controller waits for a response from the RADIUS server.
- **RADIUS Encryption Protocol:** the authentication method used by the controller to encrypt user passwords. This is either Password Authentication Protocol (PAP) or Challenge-Handshake Authentication Protocol (CHAP).
- **RADIUS Server Shared Secret:** The shared secret between the controller and the RADIUS server. Set this value by using the **Set Shared Secret** button. You can clear the configured shared secret by using the **Clear Shared Secret** button.

17.7.2. TACACS+ Authentication

Terminal Access Controller Access Control System Plus (TACACS+) is a client/server protocol and software that enables clients to communicate with a central server to authenticate and authorize their access to the requested system or service. This section of the manual describes TACACS+ authentication and authorization, its features, and how to setup the CXC-HP as a TACACS+ client.

Note: See your TACACS+ server documents for any detailed information on setting up the TACACS+ server.

17.7.2.1. Using TACACS+ Authentication

The CXC HP controller can be configured to use a TACACS+ server to remotely authenticate users. In this case the controller is acting as a TACACS+ client. A TACACS+ server, such as TACACS.net, must be configured separately for remote authentication to work correctly.

 **Note:** See your TACACS+ server documentation for information about setting up the TACACS+ server.

The following are features for using TACACS+ authentication.

- **Encryption Protocol:** provides encrypted Password Authentication Protocol (PAP), Challenge-Handshake Authentication Protocol (CHAP), or ASCII Authentication.
- **Encrypted TACACS+ Secret Key:** provides a securely encrypted, secret key which is not sent between the CXC-HP and the TACACS+ server. The secret key must be set identically on both the CXC-HP and the TACACS+ server.
- **Test TACACS+ Server Settings:** provides a check to determine if the basic TACACS+ configuration is set correctly. This feature additionally completes a trial authentication request to ensure it can contact the TACACS+ server.
- **Network:** Operates on the Transmission Control Protocol (TCP)

 **Note:** The **Test TACACS+ Server Settings** feature cannot determine if the **Attribute Name** and **Group Attribute** values are spelled correctly since these are set on the TACACS+ server side.

How TACACS+ Authentication Works

When a user logs in when the **Remote Authentication Type** field is set to **TACACS+ (RADIUS is disabled)** on the controller, the CXC-HP will begin communication with the TACACS+ server. A packet body containing the user's credentials will first be encrypted and sent to the server; depending on the **TACACS+ Encryption Protocol** selected, there may be multiple messages sent between the CXC-HP and the TACACS+ server.

If the TACACS+ sever authenticates the user, the CXC-HP will then send a TACACS+ Authorization request. At this point, the TACACS+ server will respond with any Attribute-Value pairs that are set within the server configuration. If any of these pairs match the **Attribute Name** and one of the **Group Attribute Values** of the User Roles Configuration table, the CXC-HP will assign the respective user privilege and proceed to log the user in. If there are no matches, the user is denied access. If two or more **Group Attribute Values** are assigned the same value, the CXC-HP will assign the first matching user role in the following order: Admin User Role, then Accounts User Role, then Operator User Role, then Restricted Operator User Role, then Guest User Role.

Upon a successful login, the encrypted user credentials are saved in the controller's cache. This can be used if there is a situation where the TACACS+ Server is unavailable.

Figure 91. TACACS+ Configuration Table

Name	Value	Actions
Remote Authentication Type	None (RADIUS and TACACS+ are disabled)	[Edit]
TACACS+ Authentication Server Address	---	[Edit]
TACACS+ Authentication Server Port	49	[Edit]
TACACS+ Timeout	3 s	[Edit]
TACACS+ Encryption Protocol	PAP	[Edit]
TACACS+ Server Secret Key	---	[Info]

Name	Value	Actions
Attribute Name	---	[Edit]
Group Attribute Value for Admin User Role	---	[Edit]
Group Attribute Value for Accounts User Role	---	[Edit]
Group Attribute Value for Operator User Role	---	[Edit]
Group Attribute Value for Restricted Operator User Role	---	[Edit]
Group Attribute Value for Guest User Role	---	[Edit]

- **Remote Authentication Type:** when set to **TACACS+ (RADIUS is Disabled)**, users are allowed to be authenticated by a TACACS+ server.
- **TACAS+ Authentication Server Address:** the DNS name or the IP address for the TACAS+ server.
- **TACAS+ Authentication Server Port:** the default port is 49.
- **TACAS+ Timeout:** the time, in seconds, that the controller waits for a response from the TACAS+ server.
- **TACAS+ Encryption Protocol:** the authentication method used by the controller to encrypt TACACS + packet bodies. This is either Password Authentication Protocol (PAP), Challenge-Handshake Authentication Protocol (CHAP), or ASCII authentication.
- **TACACS+ Server Secret Key:** The secret key stored on both the CXC-HP and the TACACS+ server. Set this value by using the **Set Shared Secret** button. You can clear the configured shared secret by using the **Clear Shared Secret** button.

 **Note:** TACACS+ credentials (User Name, Secret Key and Password), the Attribute Name, and Group Attribute Values must contain only printable ASCII characters.

17.8. Flash Maintenance

This section of the manual covers, **Using Memory Status** to see memory and disk usage, as well as **Performing a Flash Refresh** when necessary.

17.8.1. Memory Status

The **Memory Status** page displays various information about flash, including:

- The types of files that are using disk space
- The total amount of disk space, and the amount remaining

- The total amount of memory, and the amount of memory being used
- The number of correctable errors on flash
- Alarms: There are three alarms, **Number Of Bit Errors High**, **Memory Usage High**, and **Disk Almost Full**

The disk space information can be used to help determine which files are taking up the most space if the controller runs out of disk space. All this information can be accessed by going to **Controller > Configure Controller > Storage and Memory**.

17.8.2. Using Flash Refresh

Over time, the flash can accumulate correctable errors. These correctable bit errors can be fixed by performing a flash refresh. A flash refresh will happen every 30 days automatically, but it can also be manually triggered.

To start a flash refresh:

1. Go to **Controller > Configure Controller > Memory Status**.
2. In the **Flash Refresh** table, click the **Run Flash Refresh** button to start a flash refresh.

 **Note:** *Flash Refresh is available in OS v4.70 and later.*

17.9. Secure Web Server

The controller supports secure web access via the Hyper Text Transfer Protocol Secure (HTTPS) protocol using TLS v1.2.

17.9.1. HTTPS And Certificate Overview

The controller can provide secured Hypertext Transfer Protocol (HTTP) over Transport Layer Security (TLS), HTTPS. HTTPS is provided by using the well-defined industry standard of implementing certificates for secured connections.

 **Warning:** *A subject matter expert or IT personnel is required to support private key and certificate management and installation to the controller and any other HTTPS configuration activities. The use of a self-signed certificate is allowed within controller. With first access to the web server, the browser will display a pop-up indicating a self-signed certificate and a “Trust” acknowledgment is required. Self-signed certificates allow you to secure a large number of controllers using a self-managed domain name address for each controller.*

 **Note:** *Secure connection can only be achieved by the browser if a domain name is used (example, <https://www.alpha.ca>). Based on web browser standards, an IP address cannot resolve to a secured connection to the controller.*

Two files must be uploaded to enable HTTPS on the controller. The public key, often referred to as the certificate, and the private key, which is a certificate verified by an independent Certificate Authority

(CA). Most modern browsers will automatically trust and accept a certificate from a known CA. Alpha recommends that subject matter expert or IT person with HTTPS experience complete this process.

17.9.2. Configuring HTTPS

The settings for HTTPS are located under **Controller > Configure Controller > Communications > Web Server**.

When first logging into a controller which has not had HTTPS enabled, the screen should look like the next figure.

Figure 92. Web Server Port Communications

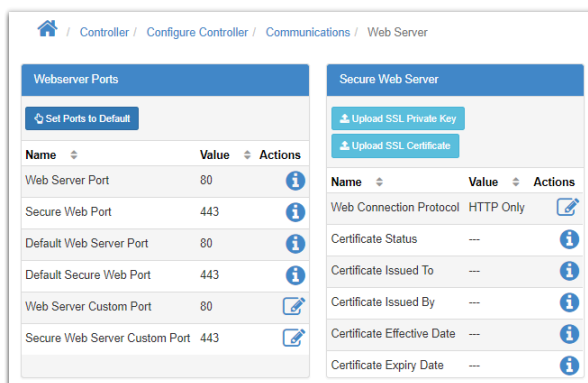

17.9.2.1. Web Server Ports

The controller has configurable web server ports on the web interface. The standard HTTP port defaults to port 80 and the standard HTTPS port defaults to port 443. Usable custom port numbers are restricted to a value above port 1024.

Note: A soft restart of the controller is required after all configurations are made when changing HTTP Server Port values.

17.9.2.2. Uploading Certificate and Key

HTTPS requires a valid certificate and a private key file to be uploaded to the controller. Using an RSA key is recommended as it is the universally accepted key type by majority of main stream browsers.

Warning: A subject matter expert or IT personnel are required to support private key and certificate management as well as installation to the controller.

The controller requires a single certificate file, which contains the specific certificate issued to the controller, along with the intermediate certificate immediately following. A copy-and-paste process can consolidate multiple certificates for this purpose. An example certificate file with two embedded certificates shown here.

Figure 93. Example Certificate

```

-----BEGIN CERTIFICATE-----
MIIFJzCCBA+gAwIBAgIJA0FbTa98HZusMA0GCsqGS1b3DQEBcUwAMIG0M0swCQYD
VQQGEwJlUzEQMA4GA1UECgMhQXJpem9uYTEtMBEGA1UEBxMKU2NvdHRzZGFsZTEa
MBgGA1UEChMRR29EYWRkeS5jb20sIE1uYy4xLTArBgNVBAsTJGh0dHA6Ly9jZj00
Cz/pHzIjedAR5evVU4dqgM3z7skyMsSQ36nF0tU48NjUC51wg8poaAb6ibeT7Pa
1W8j1eUJoav+nUj1vXBZsjmQRbZUYsrCPX5
-----END CERTIFICATE-----
-----BEGIN CERTIFICATE-----
MIIE0DCCA7iGAwIBAgITBBzANBgkqhkiG9w0BAQsFADCBgzELMAkGA1UEBhMCVWxk
EDA0BgNVBAGTB0FyaXpvcmlExeXARBgNVBACTC1Njb3R0c2RhbGUxGjAYBgNVBAoT
GIo/iKGI31b5/6kA11bRrLDYGCd+H1QQc7CoZDDu+8CL9IIV05EFdkKrqeKH+2x
LXY2JtwE65/3YR8V3Idv7kaWKK2hJn0KCacuBKONvPi8BDAB
-----END CERTIFICATE-----

```

A completed installation of the private key and certificate file result in a Valid response.

Figure 94. Valid Certificate

Name	Value	Actions
Web Connection Protocol	HTTP Only	
Certificate Status	Valid	
Certificate Issued To	*.aldev.ca	
Certificate Issued By	Go Daddy Secure Certificate Authority - G2	
Certificate Effective Date	2/13/2018 3:19:01 PM	
Certificate Expiry Date	2/13/2019 3:19:01 PM	

An incomplete installation will result in an Invalid response. An incomplete installation (if only the key or the certificate is installed), will result in an Incomplete response.

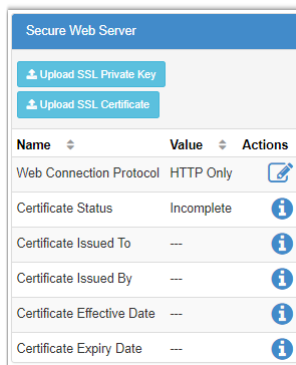
Figure 95. Incomplete Certificate

If both the key and certificate have been uploaded, but there is a problem with either one of these the files, the status will also be Invalid.

The controller ensures secured storage of the private key to prevent unauthorized access to the file.

17.9.2.3. Enabling HTTPS

Once a valid SSL key and certificate have been uploaded, HTTPS can be enabled by editing the field called **Web Connection Protocol**. There are three choices available:

- HTTP Only: this is the default, the web server will only listen on the regular HTTP port.
- Both HTTP and HTTPS: this means that the web server will listen on both the regular HTTP port and the HTTPS port. Users can connect using either. If you connect via http:// this is not a secure access protocol.
- HTTPS Only: this is the recommended setting for the most security. The web server will only listen and respond to requests on this port. Users **MUST** access the web server via a URL starting with https:// or they will be unable to connect.

After any change to the **Web Connection Protocol** setting, the controller must be restarted before the changes take effect. The **Restart Required** alarm will activate as a reminder.

Important: Enabling HTTPS means that every packet passed between the client, and the server is encrypted and then decrypted again on the other side. This slows the browser considerably. How much, depends on which browser and which type of encryption cipher is negotiated between client and server.

17.10. VLAN Support

If the controller's operating system supports VLAN tagging (OS version 4.30 and above), the controller can operate on VLAN tagged networks.

To configure the VLAN feature, go to **Controller > Configure Controller > Communications > Ethernet > VLAN Support**.

Figure 96. VLAN Support

Name	Connection	IPv4 Address	IPv4 Subnet Mask	IPv4 Router	IPv4 DNS Server	IPv6 Address	Actions
Ethernet/Front	OK	10.10.10.201	255.255.255.0	10.10.10.254	10.10.10.255	fe80::3153:c134:2342:b382	
Ethernet/Rear	OK	10.1.24.100	255.255.252.0	10.1.27.254	10.1.0.2	fe80::c5fe:2c64:525a:2176	

Name	Value	Actions
Web Server	80	
Network Time Service	123	
SNMP GET	161	
SNMP Notification	162	
Modbus	502	
SMTP Server Port	587	

Name	Value	Actions
VLAN Support	Disabled	
Enable On Interface	---	
VLAN Tag ID	---	

If the operating system does not support VLAN, the configuration fields are not editable.

After making the changes described below, restart the controller to have the changes take effect. A **Restart Required** alarm activates as a reminder.

1. Set **VLAN Support** to **Enabled**.
2. Choose which interface to enable VLAN on: the rear Ethernet port, or the front Ethernet port.
3. Choose a VLAN tag number.
4. Restart the controller.

Figure 97. VLAN Support Table

VLAN Support		
Name	Value	Actions
VLAN Support	Enabled	
Enable On Interface	Ethernet/Rear	
VLAN Tag ID	102	

17.11. Testing Relays

A common maintenance activity is to periodically verify that controller relays actuate and successfully communicate controller alarms to remote monitoring equipment. Relays can be tested from the ADIO details on the **Modules** menu or the **Maintenance** menu on the LCD.

To test relays on the LCD :

1. Go to **Maintenance** menu from the LCD dashboard.
2. Scroll down to the **Test Relays** row.
3. Click the relay symbol on the right hand side. A list of all relays is shown.
4. Select a relay to and click the arrow on the right hand side. A **Test Relay** action is shown at the top of the screen with the relay status underneath it.
5. Select the **Test Relay** action and click the arrow on the right hand side. If you are prompted to login, press the **Login** button and enter user credentials.
6. Press the **Execute** button to start the test. The relay will change state for one minute before reverting.
7. To stop the test or to restart the test, press the back arrow.

18. Maintaining Modules

When maintaining your modules always check for known issues within the readme file that ships with your software. This section of the manual covers the following:

- ADIO configuration and maintenance
- Module firmware upgrades

18.1. ADIO Maintenance

To locate connected ADIO devices go to **Modules**, and then click **Locate**. The LEDs on the selected ADIO will flash.

18.1.1. Configuring an ADIO

To configure an ADIO:

1. To view status of inputs and outputs go to **Modules** and select an ADIO.
2. To configure a digital input, click the more details icon for the selected digital input. Active state can be configured as **Energized** or **Not Energized**.

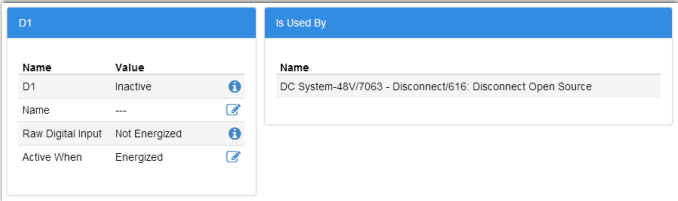

3. To configure a relay, click the more details icon for the selected relay. Normal position of the relay can be set to **Energized** or **Not Energized**. A relay can also be set to de-energize if communication is lost between the controller and the ADIO. To do this, set the **Comms Lost Action** to **De-Energize on Comms Lost**. This feature was added in controller software v6.10 and requires up-to date firmware on the ADIO. This feature cannot be used on relays that are used for control functions, like disconnects.

Name	Value	Actions
K2	Abnormal, Not Energized (N.C. contacts closed)	
K2 Name	---	
K2 Normal Position	Energized (N.O. contacts closed)	
K2 Test Status	Test Allowed	
K2 Comms Lost Action	De-energize on Comms Lost	

- To change the calibration, click the more details icon for the selected analog input. You must be logged in as an Administrator to run the **Factory Calibration** wizard.
- The **Comms Lost Timeout** should normally left at the default value. It is only used in advanced configurations with a redundant controller and ADIO.

18.1.2. Replacing an ADIO

ADIO modules have a lot of configuration and often have many links to things such as the system voltage or alarm relays. Because so much configuration is tied to an ADIO, there is a command for replacing the ADIO that retains all of its configuration.

To replace an ADIO:

- From the main dashboard, go to **Modules**.
- Use the **Locate** button to find the two ADIOs, the old one (to be replaced) and the new one. It may be useful to note the two serial numbers, in the identity column, if there are multiple ADIOs in the list.

The Locate button will only work on ADIO that have “Normal” Communication status.

Identity	Model	Firmware	System	Bus	Node	Comm. Status	Alerts	Actions
6I-ADIO/378000014	6I-ADIO	1.01	Test Site 10 (Controller)	CAN1	2	Normal	---	
6I-ADIO/378000005	6I-ADIO	---	Test Site 10 (Controller)	CAN1	---	Communication Lost	---	

- Click the **Replace ADIO** button and the wizard guides you through the process.

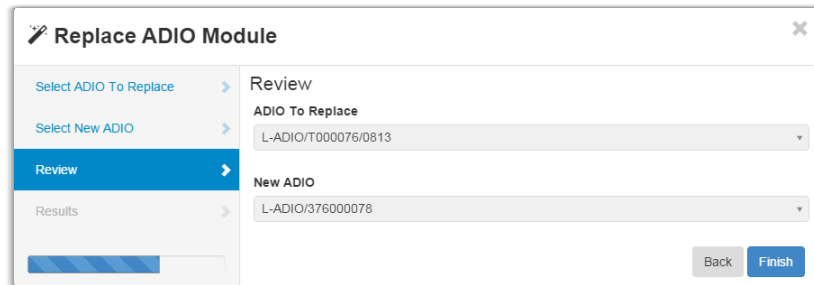

4. Click the **Finish** button to accept the change. The resulting table should have the new ADIO in it along with all of the mappings and configuration from the old ADIO.

Identity	Model	Firmware	System	Bus	Node	Comm. Status	Alerts	Actions
6I-ADIO/378000014	6I-ADIO	1.01	Test Site 10 (Controller)	CAN1	2	Normal	---	Localize Replace ADIO

5. Verify the ADIO.

Verify that the new ADIO is reading the inputs correctly, and that any inventory items are reporting the correct values. For example, check that the load or battery current readings are correct.

18.1.3. Calibrating Analog Inputs

Note: Calibration is considered an expert user task. Users must be logged in with Administrator privileges to perform this calibration.

This section covers the calibration of analog inputs on the ADIO including voltage, current, current transducer and temperature. This calibration method is only supported for the Cordex HP family of ADIO modules. Older ADIO modules such as the Shunt Multiplexer can be monitored via the CXC HP but cannot be calibrated.

The factory calibration of Cordex HP ADIO modules is very precise. It should not be a normal practice to recalibrate them in the field. If you need to apply a deliberate mis-calibration, Alpha recommends the use of custom data fields to document and perform this type of conversion.

If the factory calibration values need to be recalculated, there are three calibration modes:

- Slope/Offset Calibration
- Single-Point Calibration
- Two-Point Calibration

Table 4. ADIO Input Calibration Modes

Mode	Description
Slope/Offset Calibration	Use Slope/Offset Calibration mode to do all of the measurements and calculations manually and then enter results into the appropriate fields. If an input has been accidentally mis-calibrated, use this mode to reset the Calibration Slope to one, and the Calibration Offset to zero, which provides reasonable values to start with.
Single-Point Calibration	Use Single-Point Calibration to adjust the Calibration Offset based on a single measured value. For voltage, current and DCCT inputs, use a Single-Point Calibration to confirm that zero volts (or millivolts) is reading as exactly zero volts on the ADIO. For a temperature input, you may want to confirm that 3.0V is being read accurately. A Single-Point Calibration only changes the Calibration Offset value. It never changes the Calibration Slope value.
Two-Point Calibration	Use the Two-Point Calibration to update Calibration Offset and Calibration Slope based on two measured values (a low-point and a high-point). For a Two-Point Calibration , connect the ADIO input to a stable voltage source that accurately generate values across the full range of the input sensor. Do not use a noisy or fluctuating input for calibration. Also, do not try to generate an accurate millivolt signal on a device not intended to work in such a low range.

You can perform calibration from the LCD as well. You must login with administrator privileges to see the **Factory Calibration** commands in the LCD.

18.1.3.1. Voltage Input Calibration

 **Note:** Calibration is considered an expert user task. Users must be logged in with Administrator privileges to perform this calibration.

To calibrate an input correctly, you need hardware to generate and measure the input signal accurately.

This topic covers how to do a **Single-Point Calibration**. If you need to do a **Slope/Offset Calibration** or a **Two-Point Calibration**, a factory calibration document should be written showing, step-by-step, how both the hardware and the software need to be used to perform an accurate calibration.

To perform a **Single-Point Calibration** on a **Voltage Input**:

1. Go to **Modules > ADIO** to view the **Voltage Inputs** table.
2. Click the more details icon of a **Voltage Input** to view its individual menu.

V1			Is Used By	
Factory Calibration				
Name	Value	Actions	Name	Actions
V1	9.277 V	i	DC System 48V/8357 Load CXR (Load/2589): Voltage	
V1 Name	---	✎	DC System 48V/8357 Load Two (Load/6084): Voltage	
V1 Calibration Offset	0.999 V	i	Up Counter/2151: Input	
V1 Calibration Slope	0.995124	i		
V1 Uncalibrated Value	8.319 V	i		

3. Click the **Factory Calibration** button to launch the Wizard.
4. At the **Select Type of Calibration** step, select **Single-Point Calibration**.
5. With a digital voltmeter, measure the voltage across the input.
6. At the **Single-Point Calibration** step, enter the reading on the voltmeter into the **Measured Value** field.

Calibrate ADIO Input

B-ADIO (L-ADIO/J0015): V1

Select Type of Calibration

Create Steps

Single-Point Calibration

Apply Calibration

Calibration Results

Single-Point Calibration

Calibrate based on a single point, by just shifting the slope up or down based upon the entered offset. Enter the measured value of the input.

Measured Value

9.432

Range: -60 - 60

Help

Use a multimeter to read the actual value of the input and enter that value here. If calibrating the null (or zero) point, ensure the input has no signal and enter 0. The live value of the input as measured by the ADIO is displayed for convenient reference.

Calibrated Value (Live)

9.272

Range: -60 - 60

Previous Next

7. Click **Next** to go to **Apply Calibration**. The wizard displays the old slope and offset and the new slope and offset. Before accepting these values, ensure that the slope is very close to 1.0 and the offset is no more than a few volts from 0.0.
8. Click **Next** to send the new offset to the ADIO module.

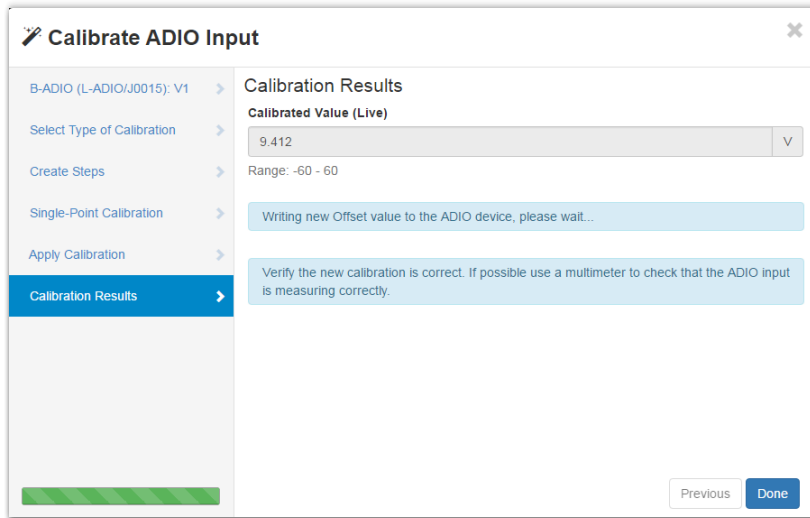

9. Verify that the newly **Calibrated Value** matches the digital voltmeter reading. Click **Done** to close the Wizard.

18.1.3.2. Shunt Input Calibration

Note: Calibration is considered an expert user task. Users must be logged in with Administrator privileges to perform this calibration.

To calibrate an input correctly, you need hardware to generate and measure the input signal accurately.

This topic covers how to do a **Single-Point Calibration**. If you need to do a **Slope/Offset Calibration** or a **Two-Point Calibration**, a factory calibration document should be written showing, step-by-step, how both the hardware and the software need to be used to perform an accurate calibration.

To perform a **Single-Point Calibration** on a **Shunt Input**:

1. Go to **Modules > ADIO** to view the **Shunt Inputs** table.
2. Click the more details icon of a **Shunt Input** to view its individual menu.

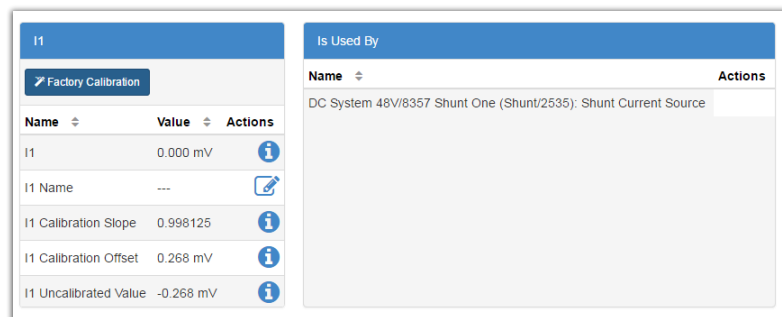

3. Click the **Factory Calibration** button to launch the Wizard.
4. At the **Select Type of Calibration** step, select **Single-Point Calibration**.

- With a digital voltmeter, measure the voltage across the input.
- At the **Single-Point Calibration** step, enter the reading on the voltmeter into the **Measured Value** field.

The screenshot shows the 'Calibrate ADIO Input' wizard at the 'Single-Point Calibration' step. The left sidebar lists the steps: L-ADIO/J0015: I1, Select Type of Calibration, Create Steps, Single-Point Calibration (highlighted), Apply Calibration, and Calibration Results. The main content area has a title 'Single-Point Calibration' and a description: 'Calibrate based on a single point, by just shifting the slope up or down based upon the entered offset. Enter the measured value of the input.' Below this is a 'Measured Value' input field containing '0.000' with a unit of 'mV' and a range of '-200 - 200'. A 'Help' section provides instructions: 'Use a multimeter to read the actual value of the input and enter that value here. If calibrating the null (or zero) point, ensure the input has no signal and enter 0. The live value of the input as measured by the ADIO is displayed for convenient reference.' At the bottom, there is a 'Calibrated Value (Live)' input field containing '-0.009' with a unit of 'mV' and a range of '-200 - 200'. 'Previous' and 'Next' buttons are at the bottom right.

- Click **Next** to go to **Apply Calibration**. The wizard displays the old slope and offset and the new slope and offset. Before accepting these values, ensure that the slope is very close to 1.0 and the offset is no more than a few volts from 0.0.
- Click **Next** to send the new offset to the ADIO module.

The screenshot shows the 'Calibrate ADIO Input' wizard at the 'Calibration Results' step. The left sidebar lists the steps: L-ADIO/J0015: I1, Select Type of Calibration, Create Steps, Single-Point Calibration, Apply Calibration, and Calibration Results (highlighted). The main content area has a title 'Calibration Results' and a 'Calibrated Value (Live)' input field containing '0.000' with a unit of 'mV' and a range of '-200 - 200'. Below this is a status bar that says 'Writing new Offset value to the ADIO device, please wait...'. A message box says: 'Verify the new calibration is correct. If possible use a multimeter to check that the ADIO input is measuring correctly.' 'Previous' and 'Done' buttons are at the bottom right.

- Verify that the newly **Calibrated Value** matches the digital voltmeter reading. Click **Done** to close the Wizard.

18.1.3.3. Current Transducer (CT) Input Calibration

 **Note:** Calibration is considered an expert user task. Users must be logged in with Administrator privileges to perform this calibration.

To calibrate an input correctly, you need hardware to generate and measure the input signal accurately.

This topic covers how to do a **Single-Point Calibration**. If you need to do a **Slope/Offset Calibration** or a **Two-Point Calibration**, a factory calibration document should be written showing, step-by-step, how both the hardware and the software need to be used to perform an accurate calibration.

To perform a **Single-Point Calibration** on a **Current Transducer Input**:

1. Go to **Modules > ADIO** to view the **Current Transducer (CT) Inputs** table.
2. Click the more details icon of a **Current Transducer (CT) Input** to view its individual menu.

DCCT1			Is Used By
Factory Calibration			Help There is no data to display
Name	Value	Actions	
DCCT1	1.496 V	i	
DCCT1 Name	---	✎	
DCCT1 Calibration Slope	1.000040	i	
DCCT1 Calibration Offset	0.027 V	i	
DCCT1 Uncalibrated Value	1.469 V	i	

3. Click the **Factory Calibration** command to launch the Wizard.
4. At the **Select Type of Calibration** step, select **Single-Point Calibration**.
5. With a digital voltmeter, measure the voltage across the input.
6. At the **Single-Point Calibration** step, enter the reading on the voltmeter into the **Measured Value** field.

Calibrate ADIO Input

HV-ADIO/37900004: DCCT1 > Single-Point Calibration

Select Type of Calibration > Calibrate based on a single point, by just shifting the slope up or down based upon the entered offset. Enter the measured value of the input.

Create Steps >

Single-Point Calibration >

Apply Calibration >

Calibration Results >

Measured Value

[v](#)

Help

Use a multimeter to read the actual value of the input and enter that value here. If calibrating the null (or zero) point, ensure the input has no signal and enter 0. The live value of the input as measured by the ADIO is displayed for convenient reference.

Calibrated Value (Live)

[v](#)

Range: -10 - 10

[Previous](#) [Next](#)

7. Click **Next** to go to **Apply Calibration**. The wizard displays the old slope and offset and the new slope and offset. Before accepting these values, ensure that the slope is very close to 1.0 and the offset is no more than a few volts from 0.0.
8. Click **Next** to send the new offset to the ADIO module.

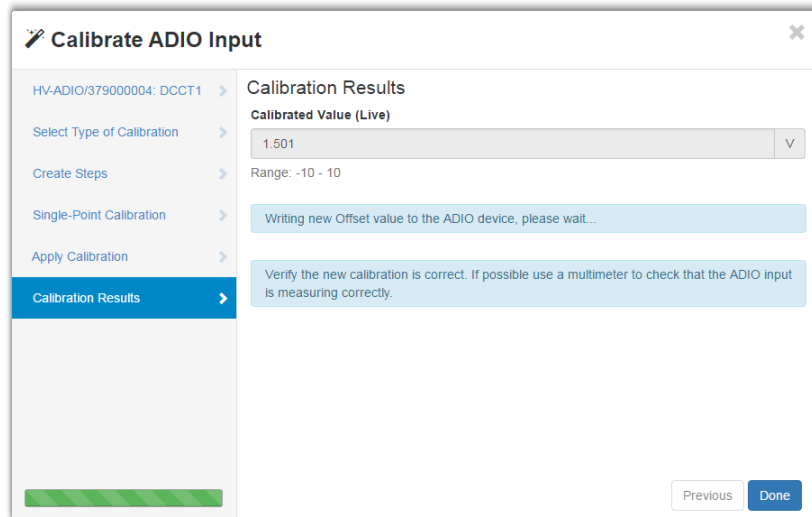

9. Verify that the newly **Calibrated Value** matches the digital voltmeter reading. Click **Done** to close the Wizard.

18.1.3.4. Temperature Input Calibration

 **Note:** Calibration is considered an expert user task. Users must be logged in with Administrator privileges to perform this calibration.

To calibrate an input correctly, you need hardware to generate and measure the input signal accurately.

This topic covers how to do a **Single-Point Calibration**. If you need to do a **Slope/Offset Calibration** or a **Two-Point Calibration**, a factory calibration document should be written showing, step-by-step, how both the hardware and the software need to be used to perform an accurate calibration.

To perform a **Single-Point Calibration** on a **Temperature Input**:

1. Go to **Modules > ADIO** to view the **Temperature Inputs** table.
2. Click the more details icon of a **Temperature Input** to view its individual menu.

T1			Temperature Probe			Is Used By		
Factory Calibration						Help		
Name	Value	Actions	Name	Value	Actions	There is no data to display		
T1 Name	---	i	T1	21.9 °C	i			
T1 Input	3.019 V	i	T1 Calculation Offset	-280.0 °C	i			
T1 Calibration Slope	0.996535	i	T1 Calculation Slope	100.0 °C/V	i			
T1 Calibration Offset	0.031 V	i						
T1 Uncalibrated Value	2.998 V	i						

3. Click the **Factory Calibration** button to launch the Wizard.
4. At the **Select Type of Calibration** step, select **Single-Point Calibration**.
5. With a digital voltmeter, measure the voltage across the input.
6. At the **Single-Point Calibration** step, enter the reading on the voltmeter into the **Measured Value** field.

Calibrate ADIO Input ✕

L-ADIO/J0015: T1 >

Select Type of Calibration >

Create Steps >

Single-Point Calibration >

Apply Calibration >

Calibration Results >

Single-Point Calibration

Calibrate based on a single point, by just shifting the slope up or down based upon the entered offset. Enter the measured value of the input.

Measured Value

V

[Help](#)

Use a multimeter to read the actual value of the input and enter that value here. If calibrating the null(or zero) point, ensure the input has no signal and enter 0. The live value of the input as measured by the ADIO is displayed for convenient reference.

Calibrated Value (Live)

V

Range: 0 - 5

[Previous](#) [Next](#)

7. Click **Next** to go to **Apply Calibration**. The wizard displays the old slope and offset and the new slope and offset. Before accepting these values, ensure that the slope is very close to 1.0 and the offset is no more than a few volts from 0.0.
8. Click **Next** to send the new offset to the ADIO module.

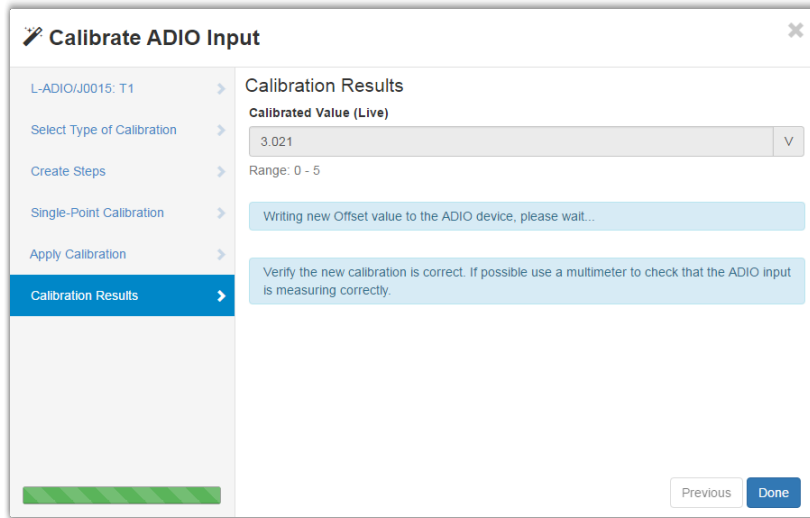

- Verify that the new **Calibrated Value** matches the digital voltmeter reading. Click **Done** to close the Wizard.

18.1.4. Calibrating Shunts, Current Transducers and Temperature Probes

This section covers the calibration of shunts, current transducers and temperature probes that are connected to ADIO inputs.

18.1.4.1. Shunt Calibration

 **Note:** Calibration is considered an expert task.

To calibrate a shunt correctly, you need hardware to generate and measure the input signal accurately.

This topic covers how to do a **Single-Point Calibration**. If you need to do a **Slope/Offset Calibration** or a **Two-Point Calibration**, a factory calibration document should be written showing, step-by-step, how both the hardware and the software need to be used to perform an accurate calibration.

A shunt **Current** reading is calculated as follows:

$$\text{Current (A)} = \left(\frac{\text{ADIO Current Input Reading (mV)}}{\text{Range in Millivolts (mV)}} \times \text{Range in Amps (A)} \right) + \text{Offset (A)}$$

To perform a **Single-Point Calibration** on a **Shunt**:

- Go to **System > Inventory > Shunts** and click the more details icon to select one of the available shunts.

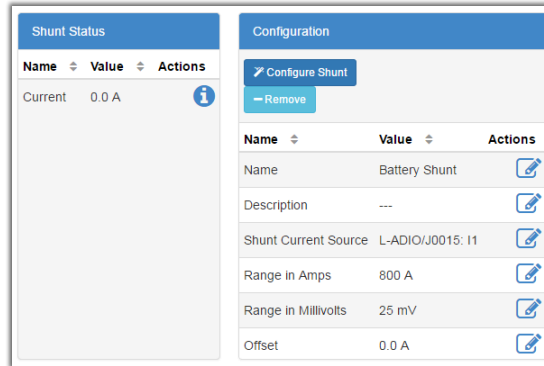

2. Set the **Offset** to zero.
3. Measure the actual current flowing in amps. It may be easiest to do this measurement at 0.0 amps.
4. Record the measured value: _____ A.
5. Subtract the displayed value: _____ A, from the Web interface.
6. Calculate the new offset: _____ A. Offset = Measured Value - Displayed Value.
7. Click the edit icon of the **Offset** field. Enter the new offset in amps and click **Save**.
8. Verify that the **Offset** field was updated, and that the new displayed value matches the measured value.

18.1.4.2. Current Transducer Calibration

 **Note:** Calibration is considered an expert task.

To calibrate a current transducer correctly, you need hardware to generate and measure the input signal accurately.

This topic covers how to do a **Single-Point Calibration**. If you need to do a **Slope/Offset Calibration** or a **Two-Point Calibration**, a factory calibration document should be written showing, step-by-step, how both the hardware and the software need to be used to perform an accurate calibration.

A current transducer **Current** reading is calculated as follows:

$$\text{Current (A)} = \left(\frac{\text{ADIO CT Input Reading (V)}}{\text{CT Range in Volts (V)}} \times \text{CT Range in Amps (A)} \right) + \text{CT Offset (A)}$$

To perform a **Single-Point Calibration** on a **Current Transducer**:

1. Go to **System > Inventory > Current Transducers** and select one of the available current transducers by clicking the more details icon.

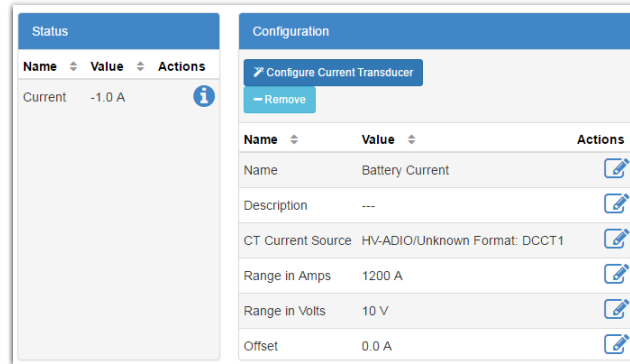

2. Set the **Offset** to zero.
3. Measure the actual current flowing in amps. It may be easiest to do this measurement at 0.0 amps.
4. Record the measured value: _____ A.
5. Subtract the displayed value: _____ A, from the Web interface.
6. Calculate the new offset: _____ A. Offset = Measured Value - Displayed Value
7. Click the edit icon of the **Offset** field. Enter the new offset in amps and click **Save**.
8. Verify that the **Offset** field was updated, and that the new displayed value matches the measured value.

18.1.4.3. Temperature Probe Calibration

 **Note:** Calibration is considered an expert task.

To calibrate a temperature probe correctly, you need hardware to generate and measure the input signal accurately.

This topic covers how to do a **Single-Point Calibration**. If you need to do a **Slope/Offset Calibration** or a **Two-Point Calibration**, a factory calibration document should be written showing, step-by-step, how both the hardware and the software need to be used to perform an accurate calibration.

A temperature probe **Temperature** default calculation is as follows:

$$\begin{aligned} \text{Temperature } (^{\circ}\text{C}) &= (\text{Voltage} - 2.73) \times 100 \\ \text{Temperature } (^{\circ}\text{F}) &= (\text{Voltage} - 2.73) \times 180 + 32 \end{aligned}$$

To perform a **Single-Point Calibration** on a **Temperature Probe**:

1. Go to **Modules > ADIO** by click the more details icon to select one of the available **Temperature Inputs**.

T1			Temperature Probe			Is Used By																	
Factory Calibration			<table border="1"> <thead> <tr> <th>Name</th> <th>Value</th> <th>Actions</th> </tr> </thead> <tbody> <tr> <td>T1</td> <td>21.9 °C</td> <td>i</td> </tr> <tr> <td>T1 Calculation Offset</td> <td>-280.0 °C</td> <td>✎</td> </tr> <tr> <td>T1 Calculation Slope</td> <td>100.0 °C/V</td> <td>✎</td> </tr> </tbody> </table>			Name	Value	Actions	T1	21.9 °C	i	T1 Calculation Offset	-280.0 °C	✎	T1 Calculation Slope	100.0 °C/V	✎	Help There is no data to display					
Name	Value	Actions																					
T1	21.9 °C	i																					
T1 Calculation Offset	-280.0 °C	✎																					
T1 Calculation Slope	100.0 °C/V	✎																					
<table border="1"> <thead> <tr> <th>Name</th> <th>Value</th> <th>Actions</th> </tr> </thead> <tbody> <tr> <td>T1 Name</td> <td>---</td> <td>✎</td> </tr> <tr> <td>T1 Input</td> <td>3.019 V</td> <td>i</td> </tr> <tr> <td>T1 Calibration Slope</td> <td>0.996535</td> <td>i</td> </tr> <tr> <td>T1 Calibration Offset</td> <td>0.031 V</td> <td>i</td> </tr> <tr> <td>T1 Uncalibrated Value</td> <td>2.998 V</td> <td>i</td> </tr> </tbody> </table>			Name	Value	Actions	T1 Name	---	✎	T1 Input	3.019 V	i	T1 Calibration Slope	0.996535	i	T1 Calibration Offset	0.031 V	i	T1 Uncalibrated Value	2.998 V	i			
Name	Value	Actions																					
T1 Name	---	✎																					
T1 Input	3.019 V	i																					
T1 Calibration Slope	0.996535	i																					
T1 Calibration Offset	0.031 V	i																					
T1 Uncalibrated Value	2.998 V	i																					

- Set the **Calculation Offset** to zero.

Do not confuse **Calibration Offset** with **Calculation Offset**. You should only read and change values in the table labeled **Temperature Probe**.

Setting the offset to zero will make the temperature reading very high and may cause temperature compensation and other temperature alarms to activate.

- Measure the actual temperature at the probe.
- Record the measured value: _____ °C or °F.
- Subtract the displayed value: _____ °C or °F, from the Web interface.
- Calculate the new offset: _____ °C or °F. Calculation Offset = Measured Value - Displayed Value
- Click the edit icon of the **Offset** field. Enter the new offset in degrees and click **Save**.
- Verify that the **Offset** field was updated, and that the new displayed value matches the measured value.

18.1.5. Testing Relays

To test relays:

- Go to **Modules** and click the more details icon of the device to be tested.
- From the **Relays** table, click the **Test Relay** button of the selected relay.
- If the relay is in and energized state it will become de-energized for one minute. If it is de-energized, it will be energized during the test. To end the test early, press the **Stop Test** button.

Relays			
Name	Value	Count	Actions
K1	Normal, Not Energized (N.C. contacts closed)	1	Test Relay ✎
K2	Normal, Not Energized (N.C. contacts closed)	1	Test Relay ✎

- Relays can also be tested by going to the individual relay menu.

Name	Value	Actions
K2	Abnormal, Not Energized (N.C. contacts closed)	
K2 Name	---	
K2 Normal Position	Energized (N.O. contacts closed)	
K2 Test Status	Test Allowed	
K2 Comms Lost Action	De-energize on Comms Lost	

18.1.6. Testing Comms Lost Action

To test the Comms Lost Action function:

1. Go to **Modules** and click the more details icon of the device to be tested.
2. From the **Relays** table, click the more details icons of the relay to be configured for the **Comms Lost Action**.
3. Ensure the relay's normal position is set to **Energized**.
4. Once configured, go to **Controller > Configure Controller > Communications > CAN** and disable each enabled CAN bus.
5. Wait five minutes.
6. After five minutes the relay configured as a comms lost relay will de-energize. Re-enable the CAN bus(es) and the relay will energize.

Note: The **Comms Lost Action** is only available on CXC-HP v6.10 and later, and firmware in the CAN module must have a version that supports this feature.

18.1.7. Enabling Temperature Sensor Failure Alarms

The **Temperature Sensor Failure** alarm activates if the voltage on the temperature input is below or above the operating range of the input. If the sensor is unplugged, the voltage will be zero and the alarm activates. If you accidentally apply bus voltage to the temperature input, the alarm activates.

To enable **Temperature Sensor Alarms** do the following:

1. Go to **Modules** and click the more details icon on the device with **Temperature Sensors**.
2. In the **Alarms** table there is one alarm for each temperature sensor on the ADIO. Click the more details icon to enable or disable the alarm for the required sensor.
3. Assign a relay or any other parameters as required.

18.1.8. Ground Fault Detection

The HV-ADIO has a ground fault detection (GFD) feature, under the **Modules > HV-ADIO** menu in the **Configuration** table, which can be enabled or disabled. It is disabled by default.

When disabled, the two related values (GFD Resistance and GFD Current) read **Unknown**, and no GFD-related alarms are triggered. These values are found under the **GFD Information** table.

When enabled, the resistance and current across the GFD circuit is reported under the **GFD Information** table. There are two alarms related to the GFD located in the **Alarms** table of the HV-ADIO.

- **Ground Fault Resistance Low** alarm will be raised if the resistance is lower than the configurable threshold, which is 20000 ohms by default.
- **Ground Fault Current High** alarm will be raised if the current is higher than the configurable threshold, which is 1mA by default.

18.2. Module Firmware Upgrades

This section covers how to upgrade the firmware on CAN devices attached to the controller.

18.2.1. Module Firmware Upgrade

To upgrade the firmware on a module, go to **Menu > Modules > Firmware Upgrade** table from either the web or the LCD touchscreen.

Figure 98. Module Upgrade Page - web

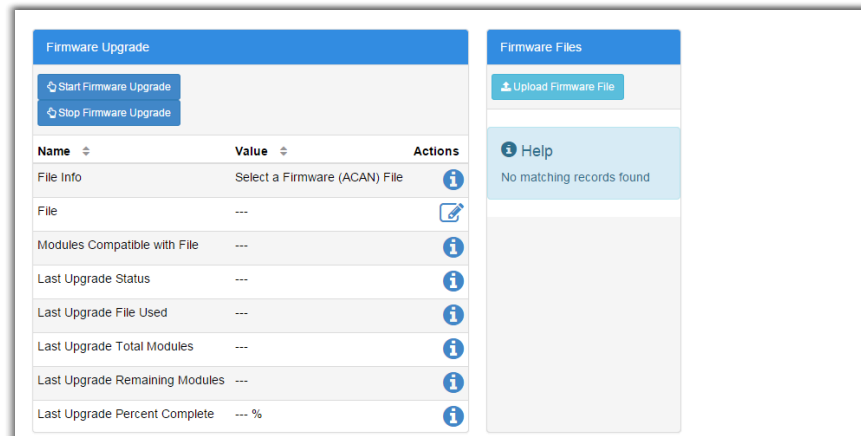
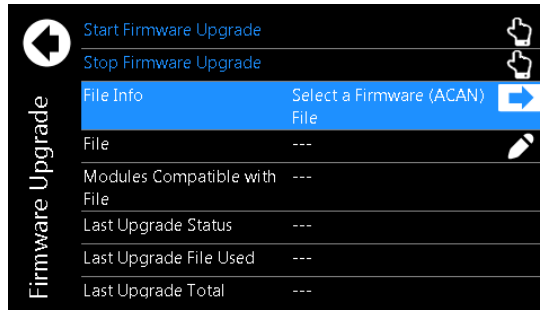

Figure 99. Module Upgrade - LCD



18.2.2. Uploading a Firmware File

Uploading a Firmware File from the LCD

From the LCD you can either choose a file uploaded from a USB drive or one from the **Local Files** folder. The **Local Files** menu contains a list of files previously uploaded via the web. Go to **Menu > Modules > Firmware Upgrade > File**.

Uploading a Firmware File from the Web

To upgrade a module over the web, the firmware file must be uploaded to the controller first.

1. Go to **Modules > Firmware Files**, and click **Upload Firmware File** table.

Figure 100. Firmware Files Table

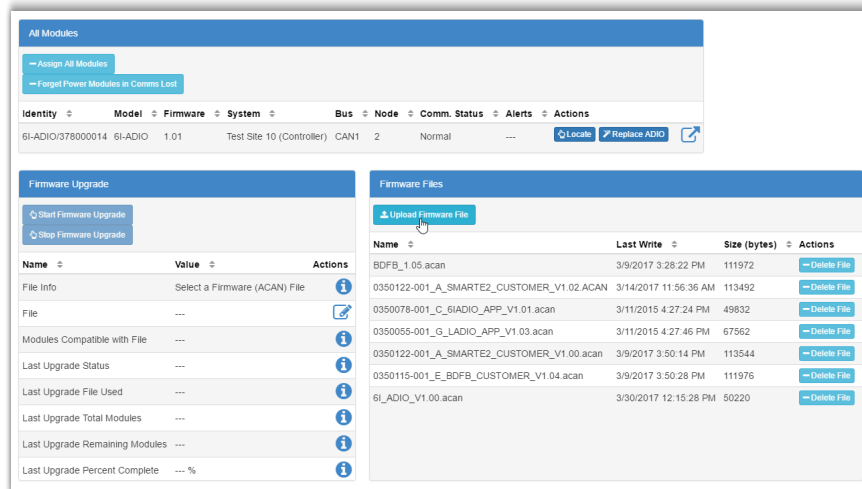

2. An **Upload File** dialog displays.
3. Click the **Select File** and choose the file to upload. Once a firmware file is selected, click the **Upload** button.

Figure 101. Upload File Dialog

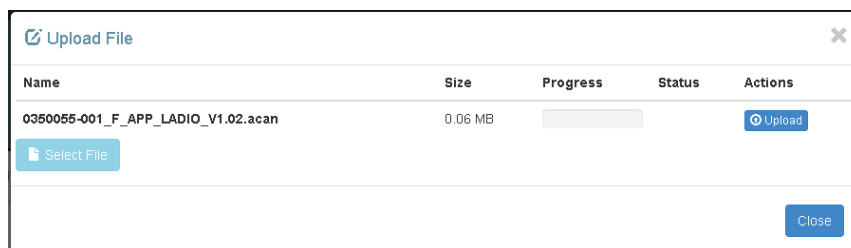

Once the file is uploaded, the dialog closes. The uploaded file is now visible in the **Firmware Files** table and available to upgrade a module.

18.2.3. Selecting the File to Upgrade

In the **Firmware Upgrade** table, there are buttons at the top to start or stop the firmware upgrade. These buttons are not active until a firmware file is selected. The first three rows of the **Firmware Upgrade** table display information about the selected upgrade file.

The rest of the table rows show information about the last upgrade that occurred. In the following **Ready to Start Upgrade** figure, the controller has been recently reset and no upgrade history displays.

The **File Info** field is informational, it displays information about how to proceed with an upgrade. Before a file is selected it displays the message, **Select a Firmware (ACAN) File**.

The **File** field is used to select a file for the upgrade. From the web, the upgrade file must be chosen from those previously uploaded to the controller. On the LCD, you can select either from the list of previously uploaded files (Local Files), or from a USB drive.

Once a file is selected, the first three rows of the table are updated with new status. If the file chosen is not a valid upgrade file, or if there are no modules to which that file can be applied, the number of **Modules Compatible With File** will be 0, and the **File Info** field will say, **Select a Different Firmware File**.

If the file is valid and applicable to your modules the **Modules Compatible With File** field will display how many devices need to be upgraded, and the **File Info** field will display **Ready to Start**. If the number of **Modules Compatible With File** is smaller than you expected or zero, it may be because some or all of the modules have already been upgraded to this version. There is no need reload a module with the same version of firmware. If the firmware is corrupt, the module will detect it and go into a **Waiting for Software** state.

Figure 102. Ready to Start Upgrade

Firmware Upgrade		
<div style="display: flex; justify-content: space-between;"> Start Firmware Upgrade Stop Firmware Upgrade </div>		
Name	Value	Actions
File Info	Ready to Start	
File	0350055-001_F_APP_LADIO_V1.02.acan	
Modules Compatible with File	1	
Last Upgrade Status	---	
Last Upgrade File Used	---	
Last Upgrade Total Modules	---	
Last Upgrade Remaining Modules	---	
Last Upgrade Percent Complete	--- %	

If an upgrade has been completed since the last restart, the bottom rows of the table will still contain information about that last upgrade until the **Start Firmware Upgrade** button is pressed.

18.2.4. Upgrading the Module

Once a valid firmware file is uploaded and the **File Info** field displays, **Ready to Start**, click **Start Firmware Upgrade**.

As the upgrade progresses, the **Firmware Upgrade** table updates with information about the upgrade. The **Last Upgrade Percent Complete** counts up from 0%, and then **Last Upgrade Remaining Modules** counts down (if there is more than one module being upgraded).

If there is more than one module being upgraded, the percent complete will show the total (100% will be reached once all modules are upgraded) instead of a per-module completion.

Figure 103. Upgrade in Progress

Firmware Upgrade		
<div style="display: flex; justify-content: space-between;"> Start Firmware Upgrade Stop Firmware Upgrade </div>		
Name	Value	Actions
File Info	Can't Select, Upgrade In Progress	
File	---	
Modules Compatible with File	---	
Last Upgrade Status	In Progress	
Last Upgrade File Used	0350055-001_F_APP_LADIO_V1.02.acan	
Last Upgrade Total Modules	1	
Last Upgrade Remaining Modules	1	
Last Upgrade Percent Complete	6 %	

The firmware upgrade can be stopped if necessary. If you press **Stop Firmware Upgrade** button the controller finishes upgrading the current module so as not to leave it in a non-functional state. If multiple modules are queued, the next module will not be upgraded.

If the upgrade fails on a module, the controller stops the upgrade and will not attempt to continue on any further modules that have been queued.

Once the upgrade is finished, the **Last Upgrade Percent Complete** displays **100%**, and the **Last Upgrade Status** displays **Succeeded**.

Figure 104. Upgrade Succeeded

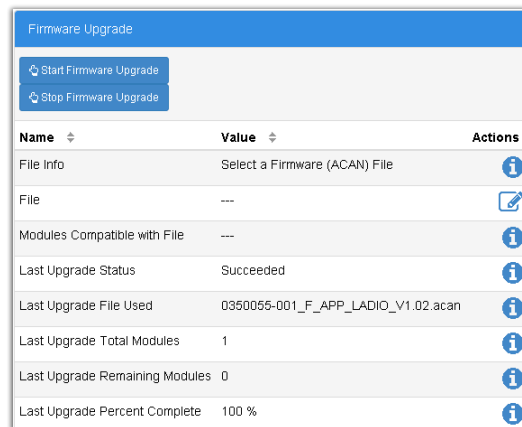

The screenshot shows a web interface titled "Firmware Upgrade". At the top, there are two buttons: "Start Firmware Upgrade" and "Stop Firmware Upgrade". Below these buttons is a table with the following data:

Name	Value	Actions
File Info	Select a Firmware (ACAN) File	i
File	---	📄
Modules Compatible with File	---	i
Last Upgrade Status	Succeeded	i
Last Upgrade File Used	0350055-001_F_APP_LADIO_V1.02.acan	i
Last Upgrade Total Modules	1	i
Last Upgrade Remaining Modules	0	i
Last Upgrade Percent Complete	100 %	i

19. Using Custom Data, Timers, Counters, Scheduler and Custom Actions

This section of the manual covers the following:

- Using Custom Data
- Using Timers
- Using Counters
- Using the Scheduler
- Using Custom Actions

19.1. Using Custom Data

The **Custom Data** feature allows you to create complex expressions that can be used to:

- Provide flexible ways to monitor and control a system
- Create custom conditions for user alarms and relay control

Custom data can be used to calculate values that represent voltages, digital inputs or currents in the system.

For example, in a system that has multiple load shunts, custom data can be used to sum all the shunt currents, and then the custom data result can be mapped to a single-load inventory item in a DC system. Custom data can also be used as the input condition for a user alarm that allows for custom control of relay outputs on ADIO devices.

19.1.1. Configuring Custom Data

Custom data has three configuration fields:

- **Name**
- **Description**
- **Equation**

There are also fields to help troubleshoot and fix equations that are not parsing correctly:

- **Custom Data Status, Error Position, Error Token and Expected Token.**

These fields provide hints to potential equation parsing errors. There is also a **Result** field that displays the result of the parsed equation. The **Result** field may show a number with up to six decimal places, if the value is numeric. Results of a boolean expression will show the conventional representation of *True* as 1.000000 and *False* as 0.000000.

Custom data can be configured via the web or the LCD. The LCD does not support creating of equations, but you can configure the **Name** and **Description**.

The custom data **Equation** field is constructed from a combination of operators, numbers, variables and functions. **Counters** and **Timers** are also supported and are described in a separate section.

Operators

Custom data supports the following arithmetic and logical operations:

- Add "+"
- Subtract "-"
- Divide "/"
- Multiply "**"
- AND "&"
- OR "|"
- Less than "<"
- Greater than ">"
- Equal "="
- Parenthesis "(" and ")"
- Unary minus "-"

Number Formats

Custom data supports the following formats for numbers:

- Decimal: "10.33" or "- 4.7" or "0.45" or ".45"
- Integer: "10" or "-4"

Variables

There are two kinds of variables: numeric and state.

Numeric variables can be used for:

- ADIO voltage, shunt, temperature

 **Note:** When using any temperature value as a variable, the value shown in the **Variables** table may appear in units of Celsius or Fahrenheit depending on the selected language. However, when the variable is used in the custom data equation it will always be evaluated using the internal representation in units of Celsius. If the calculations must be done in units of Fahrenheit it is necessary to explicitly convert the value in the equation itself. For example, if the variable is named "T" and is showing as "71.3°F", then the equation should use "(T*1.8+32)" instead of just "T". This will convert the Celsius value of "21.8" to the Fahrenheit value.

- System values including **Total Load Current**, **Time Remaining in Equalize**

 **Note:** Some time-spans such as **Time Remaining in Equalize** may appear in the format "d h m s" rather than in decimal form. In this case, the time unit used to evaluate the custom data equation will be shown in the selection panel when choosing the numeric variable's **Field** source; the

unit will be shown in parenthesis. For example, if the variable value shows as “1h 10m (m)”, then the equation will be calculated using 70 minutes.

- System inventory values including **Load Breaker/Fuse**, **Countdown to LVD**, **Load Disconnect**
- Rectifier group values including **Estimated AC Mains Voltage**, **Total Output Power**, **Number of Failed Rectifiers**
- Converter group values including **Total Installed Capacity**, **Number of Acquired Converters**
- Counter and Timer values including, **Counter Output**, **Delay Time Remaining**
- Other **Custom Data**

State variables can be used for:

- Alarms states (active, disabled, acknowledged, etc)
- Battery Modes (charging, discharging, conditioning, etc)
- Charging states (idle, active, etc)
- Breaker states (open, closed)
- Digital inputs (active, inactive)
- Disconnect states (active, inhibited, pending, inactive, etc)

A state variable compares the live value of a state field to up to four of its possible values. The possible values are called “True If” values since the state variable will evaluate to True if the state field matches any of the possible values.

 **Note:** *State variables will always evaluate to True or False. A state variable should always be used with a value that represents a state. Numeric values should not be used when creating a state variable.*

Tips on using variables:

- The keywords “True” and “False” can also be used in an equation. They are treated as built-in variables that represent the value of one and zero.
- Variables are created within the context of a single unique instance of **Custom Data**. A variable created for use in a specific **Custom Data** equation cannot be reused in another equation.
- Variable names must adhere to a specific format. The name must start with a letter, followed by letters, digits or underscores. Some valid names are “T1”, “T_1”, “Vbat”, “BatteryCurrent”, “Load_2_Current”
- Short but meaningful names offer the best readability when used in an equation.

Once **Custom Data** has been created it can be used throughout the controller and systems as input to various configurations.

For example, in a **User Alarm** all **Custom Data** displays in the selection list of the **Source** field. You can use this **Custom Data** to alarm and control relays based on any custom parameters required.

Another example is configuration for a load. The **Load Current Source** field displays all **Custom Data** so you can sum multiple currents to represent the load current.

Generally, any **Source** field that allows you select inputs will also provide all **Custom Data** as an option.

Functions

There are three supported functions: `abs()`, `sqrt()`, `power()`. The `abs()` and `sqrt()` accept a single input parameter, and the `power()` accepts two parameters. For the `power()` function, the first parameter is the base and the second parameter is the exponent. For example, `power(2,3)` would evaluate to 8.

19.1.2. Creating Custom Data

Creating custom data can be challenging, depending on the complexity of the equation required. The following section describes a basic work flow that applies to all custom data, followed by a more detailed work flow for how to create an equation with multiple variables.

Finally, there are two examples provided: one for summing shunt readings for a load, and a second for creating a user alarm to detect if an air conditioning unit in a room is set too low.

19.1.3. Creating Custom Data - Basic Work Flow

The basic work flow for custom data is the same, regardless of what kind custom data is being created.

To create new custom data here is the basic work flow:

1. Create the new **Custom Data**.
2. Configure a **Name** and **Description**.
3. Create the variables.
4. Enter the equation.
5. Verify that the equation is valid.
6. Test the equation.

19.1.4. Creating Custom Data - Detailed Work Flow

The following steps describe a general, detailed work flow for creating custom data.

1. Go to **Controller > Advanced Functions > Custom Data**. This table displays all the custom data available in the controller.
2. Press the **Add Custom Data** button. A new custom data line displays. Click the more details icon.
3. There are two tables: **Configuration** and **Custom Data Variables**. The **Custom Data Variables** table shows all the variables that have been created for this custom data. Initially it will be empty.
4. In the **Configuration** table, enter a name and description for your custom data. The description is optional but a name is highly recommended.
5. In the **Custom Data Variables** table, click the **Add Numeric Variable** or **Add State Variable** button depending on the type of variable to be used. A new variable line will display, click the more details icon.
6. From the new **Variable** table enter: **Name**, and **Description**. Give the variable a short, but meaningful name because this is the name used in the equation.

- Click the **Field** edit icon. A selector screen displays (see the following figure). To use the selector, click an item from the left-most column. A new set of selections displays to the right. Keep clicking until you have the value needed. Click **Save**.

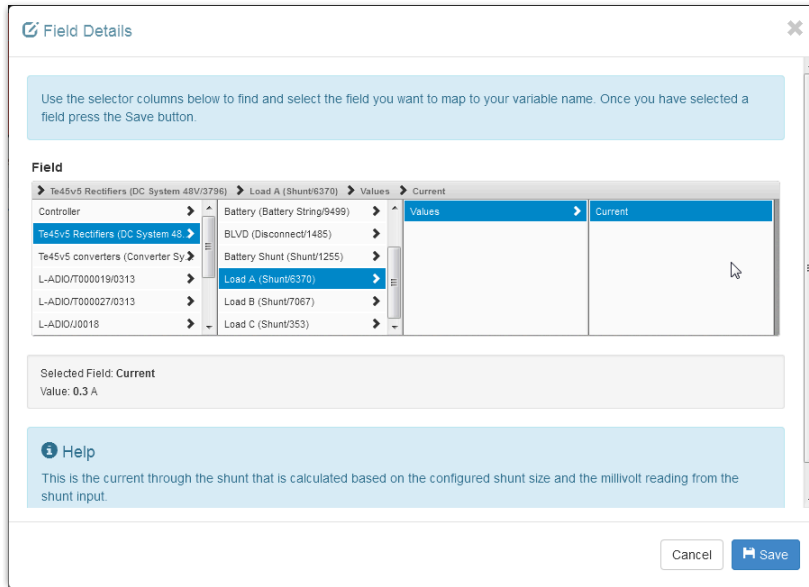

Once a field is clicked, the bottom area of the screen displays the name, value and additional information within the **Help** text.

- If this is a state variable, also select up to four “True If” values.
- Repeat steps 5 through 8 to create as many variables as required.
- After all variables have been created, click the edit icon for the **Equation** field on the **Configuration** table. Enter the desired equation.

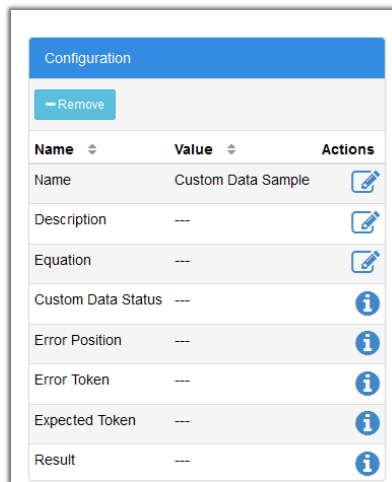

- Verify that the **Custom Data Status** field shows **Valid**. If it does not, use the information provided to find and fix the error. The **Error Position**, **Error Token** and **Expected Token** may provide helpful information.

If possible, test the equation to ensure it is providing the expected value.

19.1.5. Custom Data Examples

The following two examples illustrate the process of using **Custom Data** for summing load shunt currents and detecting if interior air conditioning is set too low and creating a **User Alarm**.

19.1.6. Custom Data - Summing Load Shunts

The following example shows how to create custom data that sums up three shunt currents, and maps the result to the system load inventory item.

- Use the steps in the detailed work flow to create custom data which sums up three variables to compute a value for the total load current in a system. When selecting a current reading, it must be selected from a shunt in the system, not at the ADIO input. It will look something like this when finished.

Configuration		
Remove		
Name	Value	Actions
Name	Total Load Current	
Description	---	
Equation	$I_a + I_b + I_c$	
Custom Data Status	Valid	
Error Position	---	
Error Token	---	
Expected Token	---	
Result	0.841626	

Custom Data Variables			
Add Variable			
Name	Field	Value	Actions
Ia (Variable/7648)	Te45v5 Rectifiers (DC System 48V/3796) - Load A (Shunt/6370): Current	0.3 A	Remove
Ib (Variable/4759)	Te45v5 Rectifiers (DC System 48V/3796) - Load B (Shunt/7067): Current	0.4 A	Remove
Ic (Variable/2574)	Te45v5 Rectifiers (DC System 48V/3796) - Load C (Shunt/353): Current	0.2 A	Remove

- To set up the **Load** to use this **Custom Data**, go to **System > Inventory > Load**, click the more details icon for the **Load** that will represent the sum of the three shunts.
- In the **Configuration** table, click to edit the **Load Current Source** field, and then use the drop-down menu to select the **Custom Data Result**. The image below shows how the custom data displays in the menu.

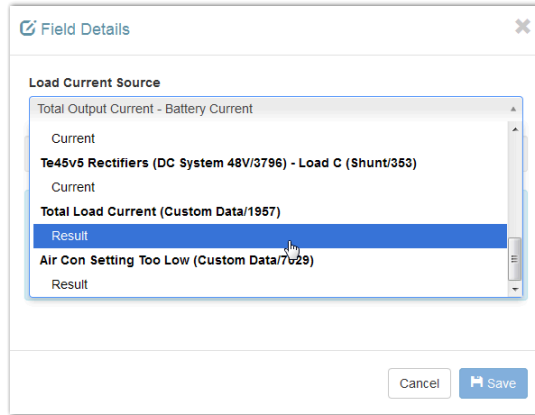

4. The **Load Current Source** field in the **Configuration** table displays the information as in the following figure.

Figure 105. Custom Data Load Current Shunts

Configuration		
Name	Value	Actions
Name	48V Load	
Description	48 Load Distribution	
Load Voltage Source	Power ADIO #1 (L-ADIO/69): System (V2)	
Load Current Source	Total Load Current (Custom Data/1957): Result	
Load Breaker/Fuse Source	---	

5. When configured, the custom data that sums the load current will look similar to the figure in step 1.

The load current now correctly shows the sum of the three shunts.

19.1.7. Custom Data - AC Cooling too Low User Alarm

The following example shows how to create a **User Alarm** that is active if it appears that the air conditioning in the room is set too low.

1. Use the steps in the detailed work flow to create custom data that has an equation which evaluates to “true” if the outdoor temperature is greater than 25°C, if the outdoor temperature is greater than the indoor temperature, and if the difference is greater than 5°C. When finished, it will look something like this.

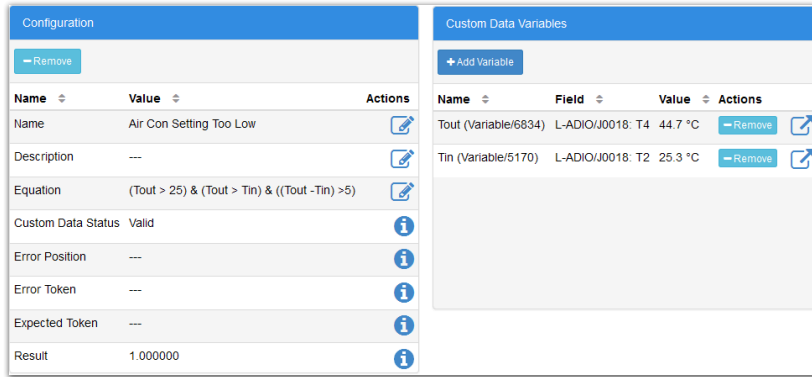

- To set up a **User Alarm** to use this **Custom Data**, go to **Controller > Advanced Functions > User Alarms**.
- Select **Add Digital User Alarm**, and click the more details icon to edit the alarm details.
- Configure the alarm name, relay and any other information required.
- In the **Configuration** table, click the edit icon on the **Source** line, and then select the **Custom Data** created to detect if air conditioning is set too low. Click **Save**. The custom data will display in the drop-down list something like this:

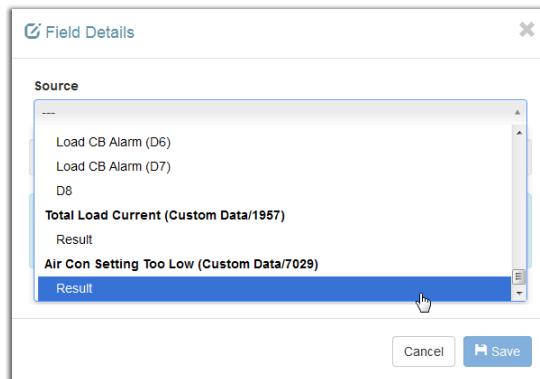

- The **User Alarm** configuration for the **Source** field should look like the following image.

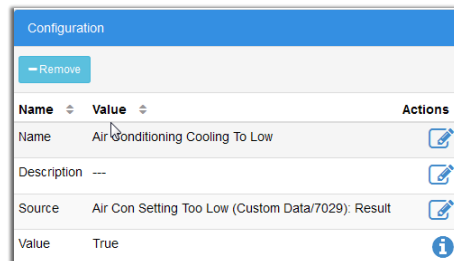

The **User Alarm** activates if the indoor temperature is too low as compared to the outdoor temperature.

19.2. Using Timers

Using the **Timers** feature you create two types of timers: a delay timer or an interval timer.

- The **Delay Timer** can be used with **Custom Data** to produce a programmable delay when a certain event happens.
- The **Interval Timer** can be used with **Custom data** to measure the time between two events.

 **Note:** An event is defined as a boolean expression that transitions from false to true or not unknown to true. Since some logical conditions can evaluate to unknown, for example when data cannot be retrieved from a CAN module, it is important to construct events so that they always transition from false to true.

For example, a **Delay Timer** might be configured to delay the start of a generator once the voltage falls below a certain value. An **Interval Timer** might be used to measure how many generator restarts occur in a 24-hour period.

19.2.1. Configuring the Delay Timer

A **Delay Timer** has eight configuration fields:

- **Name**
- **Description**
- **Delay:** the amount of time for the timer delay.
- **Auto Reset:** when enabled, the timer is stopped and the output is set to **False**
- **Output True When:** determines when the timer output is True - **When Running** or **When Delay Over**
- **Retrigger:** when enabled, the timer can be continuously re-triggered when the **Trigger** goes from false to true before the delay time elapses. When the timer is re-triggered, the **Delay Time Remaining** starts counting down again from the configured delay time and the output will stay true.
- **Trigger Source:** the field that represents the **Trigger** value. It is usually set to the result of a custom data.
- **Reset Source:** an optional field that represents the **Reset** value. It is usually set to the result of a custom data.

There are also fields to describe the state of the **Delay Timer**:

- **Output:** this value will be true when the timer is on and the delay is active.
- **Delay Time Remaining:** the number of seconds remaining in the delay.
- **Trigger:** the value of the timer trigger. When this value goes from false to true, the delay timer starts and the output goes true as long as the **Reset** value is false.
- **Reset:** the value of the timer reset. When this value is true, the timer output will be false.

The **Reinitialize Timer** button can be used if the timer configuration has been changed while the timer is active.

 **Note:** *It is also possible to test the timer or force it into a desired state using the **Force Timer to Start** and **Force Timer to End** buttons, even if **Start Event** has not been configured.*

- **Force Timer to Start** simulates the **Start Event** going from false to true.
- **Force Timer to End** sets the **Delay Time Remaining** going to zero and the timer going into its terminal state.

Delay Timer Operation

The **Delay Timer** operates as follows:

- When the **Reset** is true, or if **Auto Reset** is enabled and the timer trigger source is false, the timer output is always false and the **Delay Time Remaining** is set to the initial value.
- When **Output True When** value is **When Running** and the **Trigger** input goes from false to true, the **Output** goes true and the **Delay Time Remaining** starts counting down from the delay value.
- When **Output True When** value is **When Delay Over** and the **Trigger** input goes from false to true, the **Delay Time Remaining** begins counting down and when it reaches 0, the **Output** goes true.
- If the timer is actively counting down seconds, and the **Output** is true when the **Trigger** input goes from false to true, the timer starts counting down seconds starting from the configured delay time for as long as the **Retrigger** is enabled.
- When the **Reinitialize Button** is pressed, the timer **Output** will be set false and the **Delay Time Remaining** is set to the initial value.

19.2.2. Configuring the Interval Timer

An interval timer has four configuration fields:

- **Name**
- **Description**
- **Start Event Source:** the field that represents the timer **Start Event**. It is usually set to the result of a custom data.
- **Stop Event Source:** the field that represents the timer **Stop Event**. It is usually set to the result of a custom data.

There are also fields to describe the state of the **Interval Timer**:

- **Output:** the output of the timer in seconds.
- **Start Event:** the present value of the **Start Event** field. It will evaluate to true or false.
- **Stop Event:** the present value of the **Stop Event** field. It will evaluate to true or false.

The **Reinitialize Timer** button can be used if the timer configuration has been changed while the timer is active.

 **Note:** It is also possible to test the timer or force it into a desired state using the **Force Timer to Start** and **Force Timer to End** buttons even if **Start Event** and **Stop Event** have not been configured.

- **Force Timer to Start** simulates the **Start Event** going from false to true.
- **Force Timer to End** simulates the **Stop Event** going from false to true.

Interval Timer Operation

The interval timer operates as follows:

- When **Start Event** goes from false to true, the timer **Output** begins incrementing seconds starting from 0.
- When **Stop Event** goes from false to true, the timer **Output** stops incrementing seconds and remains at the value it had at the Stop Event time.
- If the timer is incrementing seconds, and the **Start Event** goes false to true again, the **Output** starts incrementing seconds starting from 0.
- When the **Reinitialize Button** is pressed, the timer Output will be set to '---'.

19.3. Using Counters

The **Counters** feature makes it possible to create an **Up Counter** or a **Down Counter** that keeps track of events. A counter can be used with **Custom Data** as a variable in an equation.

 **Note:** An event is defined as a boolean expression that transitions from false to true.

For example, an **Up Counter** might be configured to increment whenever the battery voltage goes below a certain value to count the number of discharges that have occurred.

19.3.1. Configuring the Up Counter

An **Up Counter** has five configuration fields:

- **Name**
- **Description**
- **Input Source:** the field that represents the **Input** value. It is usually set to the result of a custom data.
- **Reset Source:** this optional field represents the **Reset** value. It is usually set to the result of a custom data.
- **Terminal Value:** this is an optional numeric value that is the maximum value.

There are also fields to describe the state of the counter:

- **Input:** the value of the field that was selected for the **Input Source**. It will evaluate to false or true.
- **Output:** the value of the counter.
- **Reset:** the value of the field that was selected for the **Reset Source**. It will evaluate to false or true
- **Terminal Reached:** this value is true when the counter **Output** is equal to the **Terminal Value**.

The counter also has a **Reinitialize Counter** button. When this button is pressed, the counter **Output** is set back to zero.

Up Counter Operation

The **Up Counter** operates as follows:

- When the **Input** value goes from false to true, the **Output** will increment by one, as long as it is less than the terminal value and the **Reset** value is false.
- When the **Reset** value is true, the **Output** will always be zero.
- The **Terminal Reached** value will be true whenever the **Output** is equal to the **Terminal Value**.
- When the **Reinitialize Counter** button is pressed, the counter **Output** is set to zero. This allows for a manual reset of the counter in case the **Reset Source** has not been configured.

19.3.2. Configuring the Down Counter

A **Down Counter** has five configuration fields:

- **Name**
- **Description**
- **Input Source**: the field that represents the **Input** value. It is usually set to the result of a custom data.
- **Initialize Source**: this optional field is used to represent the **Initialize** value. It is usually set to the result of a custom data.
- **Initial Value**: the initial value of the **Down Counter**.

There are also some fields to describe the state of the counter:

- **Input**: the value of the field that was selected for the **Input Source**. It will evaluate to false or true.
- **Output**: the value of the counter.
- **Initialize**: the value of the field that was selected for the **Initialize Source**. It will evaluate to false or true.
- **Counter at Zero**: this value is true when the counter **Output** is equal to zero

The counter also has a **Reinitialize Counter** button. When this button is pressed, the counter **Output** is set back to the initial value.

Down Counter Operation

The down counter operates as follows:

- When the **Input** value goes from false to true, the **Output** will decrement by one, as long as it is greater than zero and the **Initialize** value is false.
- When the **Initialize** value is true, the **Output** will always be equal to the **Initial Value**.
- The **Counter at Zero** value will be true whenever the **Output** is equal to zero.
- When the **Reinitialize Counter** button is pressed, the counter **Output** is set to the **Initial Value**. This allows for a manual reset of the counter in case the **Initialize Source** has not been configured.

19.4. Using Scheduler

The **Scheduler** feature makes it possible to create actions which can occur or recur at specific times or dates. With this feature you can:

- Schedule a single action
- schedule a recurring action, hourly, daily, weekly or monthly

The **Scheduler** can be used to do the following:

- Equalize the batteries on a DC system
- Run a battery test on a DC system
- Put a DC system back into float mode (canceling any equalize or battery test)

 **Note:** *Equalize or Battery Test have user configurable termination conditions in their menu settings, therefore it is generally not necessary to schedule an end within Scheduler.*

19.4.1. Configuring a Recurring Action

To create a recurring action:

1. Go to **Controller > Advanced Functions > Scheduler**. A table displays available options.
2. Press the **Create Scheduled Action** button to launch the wizard.
3. Follow the instructions to set up the schedule type, start date and time, recurrence interval, Actions and an end condition if required.

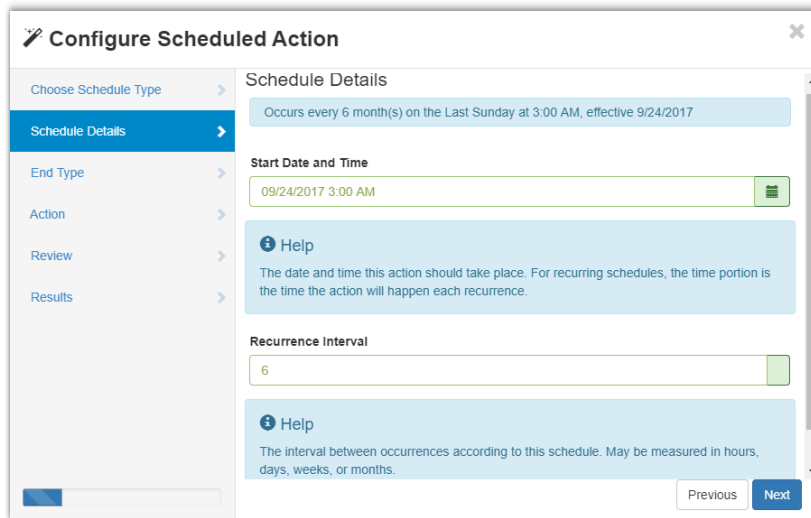

The table displays the new **Scheduled Action**, and when that action will run.

Status		
Name	Value	Actions
Recurrence	Occurs every 6 month(s) on the Last Sunday at 3:00 AM, effective 9/24/2017	
End	After 10 occurrences	
Schedule Status	Waiting	
Last Run	9/24/2017 3:00:02 AM	
Next Scheduled Run	3/25/2018 3:00:00 AM	
Total Executed Runs	1	

Configuration		
Configure Scheduled Action		
Remove		
Name	Value	Actions
Name	---	
Description	---	
Action	DC System 48V/5928: Request Equalize Mode	

A **Scheduled Action** can also be triggered manually by clicking **Trigger Action Manually**. This is intended to be used for testing during configuration.

19.5. Configuring a One-Time Action

To create a one-time scheduled action:

1. Go to **Controller > Advanced Functions > Scheduler** . A table displays available options.
2. Press the **Create Scheduled Action** button to launch the wizard.
3. Follow the instructions to set up the **One Time, Scheduled type**, and the **Action** to be performed.

The table displays the new **Scheduled Action** and when that action will run.

Status		
Name	Value	Actions
Recurrence	Occurs once on 9/3/2017 at 1:00 PM	
End	---	
Schedule Status	Waiting	
Last Run	---	
Next Scheduled Run	9/3/2017 1:00:00 PM	
Total Executed Runs	0	

Configuration		
Name	Value	Actions
Name	---	
Description	---	
Action	DC System 48V/5928: Request Battery Test Mode	

19.6. Configuring Scheduled Actions

The controller wizard is used to create and configure scheduled actions, with the exception of the **Action** field. The **Scheduler** has five configuration fields. The first four can only be configured via the wizard.

- Schedule Type - one time, hourly, daily, weekly, monthly
- Start Date and Time - This is the date the event takes place. For recurring events, time is the specific time of day each event runs (with the exception of hourly events)
- Recurrence Interval - The time between occurrences (every three hours, every six months, etc.)
- End Type - can be set to never end,, end by a date, or end after a certain number of occurrences
- Action - the specific action that runs at each interval

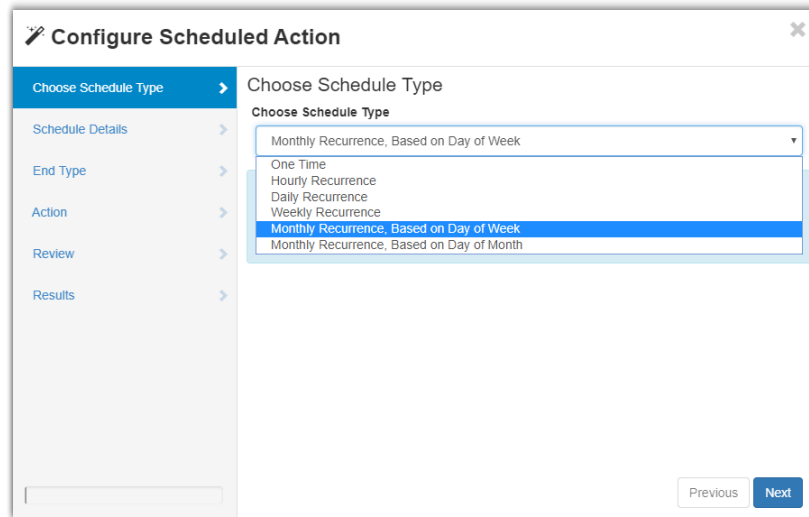
Figure 106. Scheduler Wizard

Additional fields describe the state of a scheduled action:

- Recurrence - A message describing when and how often an action will occur.
- End - a message detailing when a recurring actions will end.
- Scheduled Status - A message describing either “waiting”, “completed” or “missed”
- Last Run - The time the last action ran
- Next Scheduled Run - The time the next action will run
- Total Executed Runs - The total number of times this scheduled action has run

In addition to the information listed in the fields, the Event Log will contain a message each time an action has run or been missed.

 **Note:** *In situations where the controller has been off and Daylight Savings Time occurs, the Scheduler runs actions up to one-hour after they are scheduled to run. **For example:** if an action is scheduled for a single occurrence, at 9/1/2017 4:00PM, and the controller is off at 3:30 PM and back on at 4:30PM, then the scheduled action will still run.*

19.7. Using Scheduled Time Spans

The **Scheduled Time Span** is used to create a daily time span using custom data, or other features that can take a boolean input (true or false, yes or no).

Using the **Scheduled Time Span**, you can configure the following:

- A name for easy identification. For example, “Morning Rush Hour”.
- A start time and end time.

- A scheduled date range, such as, on all days, on weekdays only, or on weekends only.

Once configured, the **Scheduled Time Span** outputs a boolean signal called **Within Time Span**. This value is true if the current time is within the time span, and false otherwise.

This boolean signal can be used in custom data to indicated whether or not the controller is operating within a given time span. One example is to create a custom data equation that would only be evaluated during certain periods of the day, or conversely, not evaluated during certain periods of the day.

19.8. Using Custom Actions

The **Custom Action** feature makes it possible to change a relay or field to different values based on a condition. With this feature you can:

- Activate/deactivate a relay based on a condition
- Change the value of a numeric configuration field based on a condition
- Change the value of a numeric configuration field to the value of a **Custom Data**

19.8.1. Configuring a Change Relay Action

Change Relay actions can be used to control equipment, external to the system, based on specific conditions. For example, in a case where external equipment should be turned on or off based on the state of the controller (i.e. turn a generator on when AC is lost). In this specific example, the condition would be to check if power has been lost, if yes, then the Relay To Change would activate, turning on the generator. To access this feature go to **Controller > Advanced Functions > Custom Actions**.

A **Change Relay** action has four configuration fields:

- **Name**
- **Description**
- **Relay To Change**: the relay that will be changing based on the specified condition
- **Condition**: a boolean field that will control the relay

There are also fields that describe the state of the action:

- **Field Value When Condition True**: what state the relay will be in when **Condition Value** is true
- **Field Value When Condition False Or ---**: what state the relay will be in when **Condition Value** is false or unknown
- **Condition Value**: the present value of **Condition**
- **Field Value**: the present value of **Relay To Change**

Change Relay Action Operation

The **Change Relay** action operates as follows:

- When the **Condition Value** is false or unknown, the relay will be in its normal state.
- When the **Condition Value** is true, the relay will be in its abnormal state.

19.8.2. Configuring a Change Field To Constant Action

The **Change Field To Constant** action feature can be used to change the value of a field based on specific situations. This can be useful to control the state of the system based on external conditions. For example, when a generator is on, the system can be set to charge the batteries at a lower rate so that it does not drain the generator.

To access this feature go to **Controller > Advanced Functions > Custom Actions**.

A **Change Field To Constant** action has six configuration fields:

- **Name**
- **Description**
- **Field To Change**: the field that will be changing based on the specified condition
- **Condition**: a boolean field that will cause **Field To Change** to change to different values
- **Field Value When Condition True**: the value of **Field To Change** when **Condition Value** is true
- **Field Value When Condition False Or ---**: the value of **Field To Change** when **Condition Value** is false or unknown

There are also fields that describe the state of the action:

- **Condition Value**: the present value of **Condition**
- **Field Value**: the present value of **Field To Change**

Change Field To Constant Action Operation

The **Change Field To Constant** action operates as follows:

- When the **Condition Value** is false or unknown, **Field To Change** will be set to **Field Value When Condition True**
- When the **Condition Value** is true, **Field To Change** will be set to **Field Value When Condition False Or ---**

19.8.2.1. To Configure a Change Field To Constant Action

One way to use a **Change Field To Constant Action** is to set **Auto DC Priority**. The following describes how to configure a **Change Field Action To Constant** to control the amount of power the Inverter System takes from DC, based on the time of day.

Go to **System > Inverter System > System Functions** and in the **Manual DC Priority** table, ensure that **Manual DC Mode** is **Enabled**.

1. Go to **Controller > Advanced Functions > Scheduler**.
2. Click the **Create Time Span** wizard to select the days and times.
3. Go to **Controller > Advanced Functions > Custom Actions**.
4. Click **Add Change Field To Constant Action**, and click more details.

5. In the **Configuration** table, select **Field To Change**, select the **AMPS HP2 system** and then **Desired DC Input Power**.

6. In the **Configuration** table, select **Condition > Time Span > Within Time Span**.

7. In the **Configuration** table, select **Field Value When Condition True** and set to 100 %.

This causes the Inverter System to pull all its power from DC during the more expensive hours for power usage.

8. In the **Configuration** table, select **Field Value When Condition False** to 0%.

This causes the Inverter System to pull all its power from AC during cheaper hours of power usage, allowing the batteries to charge during that time period.

19.8.3. Configuring a Change Field To Variable Action

The **Change Field To Variable** action feature can be used to change the value of a field to the value of a **Custom Data**. This can be useful to control the state of the system based on external conditions. For example, the rectifier's power output can be adjusted based on a limit to the amount of AC power that should be consumed.

To access this feature go to **Controller > Advanced Functions > Custom Actions**.

A **Change Field To Variable** action has five configuration fields:

- **Name**
- **Description**
- **Field To Change**: the field that will have its value changed to the value of the configured **Custom Data**
- **Set Field To Custom Data**: the value of **Field To Change** will be set to the value of this **Custom Data**
- **Field Value Change Interval**: the number of seconds between each time the value of **Field To Change** will be set to the value of **Set Field To Custom Data**

There are also fields that describe the state of the action:

- **Last Error Condition**: describes if there are any errors, either with the configuration or the operation of this action
- **Field Value**: the present value of **Field To Change**
- **Field Range**: the range for **Field To Change**. The value of **Field To Change** will only be set if the value of the configured **Custom Data** is within this range
- **Custom Data Value**: the present value of **Set Field To Custom Data**
- **Time To Next Possible Change**: the amount of seconds until the next time **Field To Change** will have its value set to the value of the configured **Custom Data**, if the value is different and within range

Change Field To Variable Action Operation

The **Change Field To Variable** action operates as follows:

- The value of **Field To Change** will be set to the value of the **Custom Data** that **Set Field To Custom Data** is configured to use
- This value will be set on an interval based on the value of **Field Value Change Interval**. For example, if this field is set to 300 seconds (the default), the value of **Field To Change** will be set every 300s
- **Field To Change** will only be set if the value of the configured **Custom Data** is different than the present value of **Field To Change**, and is within range for this field

20. Troubleshooting

This section of the manual covers the following:

- Troubleshooting the controller
- Troubleshooting the system

20.1. Troubleshooting Your Controller

This section of the manual covers possible issues and fixes for your controller. Also see the readme notes that ship with the CXC HP software.

20.1.1. No Communication

Check all connection cables.

Check the controller settings via the **Controller > Configure Controller > Communications > Ethernet**.

Ensure that the controller is configured to communicate via the web. See *Getting Started* and *Setting Up Controller Communication*.

Ensure that both ports in the Ethernet table have the address mode configured correctly.

 **Note:** *The default IPv4 configuration for the controller must have the rear Ethernet port set to automatic (DHCP) and the front Ethernet port set to manual (static).*

20.1.2. Unable to Communicate via Ethernet

Confirm that all cables are firmly connected.

1. Go to **Controller > Configure Controller > Communications > Ethernet**.
2. Ensure that the IP address settings are correct.
3. Edit the settings if required.
4. Click **Save**.
5. If that does not work, then reset the controller.

 **CAUTION:** *Pressing the reset button restarts the controller using the last settings that were saved.*

If the issue is not resolved, contact your IT department to confirm that both the controller and the computer can communicate across the network.

20.1.3. Home Button or LCD Screen Not Responding

If the controller is not responding to touch or the **Home** button is not responding to touch, you can perform a controller reset.

 **CAUTION:** *Pressing the reset button does not ensure that the settings are saved.*

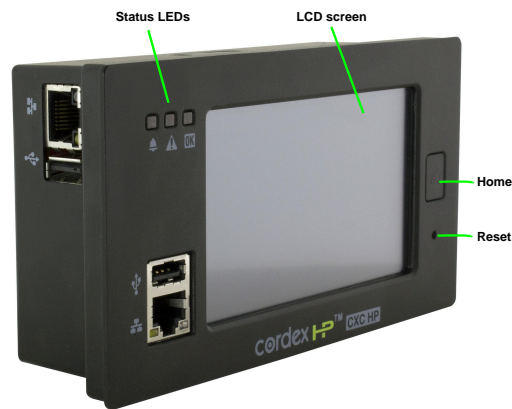

To perform a hardware reset:

1. From the front of the controller, press the reset button.

20.1.4. Controller Fail

The controller has a relay that can be used to indicate the controller power has failed. This relay is labeled **Alarm** and is located beside the power connector. In-shelf versions of the controller do not have this relay.

When the controller is operational, the relay is in the NO position. When the controller power has failed this relay is in the NC position. If voltage is applied to the power connector and the **Alarm** relay is in the NC position and the controller does not start up, it is likely the controller has failed and should be replaced.

In-shelf controllers (i.e. CXC-HPM1) do not have a dedicated controller fail relay. Failure of an in-shelf controller may result in relays becoming de-energized. These de-energized relays function as a controller fail relay.

 **Note:** *The controller fail relay is not programmable in any way.*

20.1.4.1. FXM-HP Controller Fail

Failure of the controller inside the FXM-HP may not result in any relay becoming de-energized since the relays are on a separate, independent CAN module.

It is recommended to use the **Comms Lost Action** setting on the relay details page. If communication is lost between the internal controller and the FXM-ADIO module, the relay will de-energize five minutes after communication is lost.

This feature is available in CXC-HP v6.10 and later. The CAN module firmware also needs to be updated to a version that supports this feature.

20.2. Troubleshooting a Rectifier System

This section of the manual covers possible issues and fixes for your system. Also see the readme notes that ship with the CXC HP software.

20.2.1. Relays Not Triggered During Alarm Conditions

If the relays are not triggered during alarm conditions try the following:

- Ensure alarm condition is mapped to a relay (**Alarms > All Alarm Settings**).
- Ensure polarity of the relay is set correctly
- Ensure Cutoff All Alarms had not been selected
- Ensure ADIO is communicating

20.2.2. Rectifier Alarms and Alerts

Alarm: An alarm is a notification of a change to the state of the controller. Alarms can be configured with thresholds (if applicable), mapped to relays and will trigger SNMP notifications.

Alert: An alert is a notification from a device that indicates a problem or change in state. An alert is not configurable. The status of an alert is viewable from a device's detailed status page. For example, to view rectifier alerts go to **System > DC System > Inventory > Rectifiers > Status**, and click the view details icon.

Rectifier Minor Alert: indicates a potential minor problem that doesn't pose an immediate risk to the rectifier's ability to output power.

Rectifier Fail Alert: indicates a problem with the rectifier's ability to output power.

If the system has an active **Rectifier Minor** or **Rectifier Fail** alarm, you can find out the source and cause of the alarm as follows:

1. Go to **System > DC System > Inventory > Rectifiers > Status** and look at the # Alerts column.
2. Look for a rectifier in the list with more than zero alerts and click the detailed status icon. The page displays a **Rectifier Alerts** table listing all possible rectifiers alerts.
3. Sort the table to find the active alerts. Click the more details icon for a description of the alert. This information should help you troubleshoot the problem.

 **Note:** A common reason for an unexpected Rectifier Fail alert is a very low load or no load resulting in a **Ramp Test Fail/No Output Power** alert. It is normal for a rectifier to have this alert active if there is no load or very low load. If your system normally operates at very low load you can disable the Ramp Test under **System > DC System > Inventory > Rectifiers > Rectifiers Configuration** to clear this alert and prevent it from activating.

20.2.3. Rectifier Not Acquired

Ensure all rectifiers are secured and tightly screwed into the shelf.

Ensure CAN cables are securely connected and routed between all necessary shelves, and to the controller.

Go to **System > DC System > Inventory > Rectifiers > Status**, and then click **Assign** in the **Modules Available for Assignment** table for the specific rectifier required.

 **Note:** *Even if a system is configured to auto-assign devices, once a rectifier has been unassigned from the system, it must be manually reassigned back into the system. This is necessary to avoid unintentional auto-assignment. If a device is unassigned using the **Forget** button, then it will auto-assign when discovered on the CAN bus.*

20.2.4. Rectifier Communication Lost

If one or more rectifiers have lost communication with the controller for more than 10 seconds an alarm generates. The alarm will clear when communication is restored to all rectifiers.

If rectifier communication is lost, first check the following:

1. Check all CAN cables for breaks or loose connections.
2. Ensure all rectifiers are secured and tightly screwed into the shelves.
3. Go to **System > DC System > Inventory > Rectifiers > Alarms**.
4. In the alarms table, click more details icon on **Rectifier Comms Lost** row to see the details.

20.2.5. Replacing a Defective Rectifier

When a rectifier fails and or is permanently removed, the system generates a **Rectifier Comms Lost** alarm.

The alarm is cleared by removing the rectifier from the system inventory.

To remove the rectifier from the system inventory do the following:

1. Remove the defective rectifier from the shelf.
2. In the web interface go to **System > DC System > Inventory > Rectifiers > Status**.
3. Click **Forget** on the rectifier to be removed and confirm.
4. Place the new rectifier in the shelf.
5. Rectifiers are plug-and-play, but you may still need to map the new rectifier to an AC phase.
6. If the rectifier shows in the **Modules Available for Assignment** table, instead of in the **Status** table, click **Assign** to assign the new rectifier.
7. Confirm the assignment.

20.2.6. Using Extended Ranges

If your 12, 24 or 48 volt DC system has a battery and rectifier modules that can operate outside of the normal ranges, you can enable Extended Ranges to allow your DC System to run outside the normal ranges.

20.2.6.1. Extended Ranges for Battery Testing

Normally, 12, 24 and 48 volt DC Systems have a fairly narrow range of voltages allowed for battery testing. These voltages are based on what is considered normal for the batteries and what is possible for the rectifiers. The ranges are set this way to avoid errors when configuring a new system. The 125 and 220 volt DC Systems have a wider range of battery test voltages because there are a wider variety of battery configurations used with those systems.

1. Go to **System > DC System > Configure System**. In the Configuration table, change the **Extended Ranges (Advanced)** setting from **Normal** to **Extended**.
2. Go to **System > DC System > Inventory > Rectifiers > Configuration**. In the Configuration table, set the **Minimum Test Voltage** to the lowest value allowed by your rectifier.
3. Go to **System > DC System > System Functions > Battery Test**. In the Configuration table, set the **Battery Test Termination Voltage** to the voltage you want the battery test to run to.

We strongly recommend that the **Battery Test Termination Voltage** on the battery test page be at least 0.5 volts higher than the **Minimum Test Voltage** on the rectifier configuration page.

20.2.6.2. Extended Ranges for Battery Equalization

Normally, battery equalization is a process designed to de-sulphate a battery's plates by holding a controlled overcharge over the period of a few hours. The Extended Ranges option will allow much longer durations than is generally used for the battery equalization process. This option helps to support systems with unusual configurations.

 **CAUTION:** *Equalization for extended periods can cause excessive gassing and plate damage.*

1. Go to **System > DC System > Configure System**. In the Configuration table, change the **Extended Ranges (Advanced)** setting from **Normal** to **Extended**.
2. **System > DC System > System Functions > Equalize and Boost**. In the Equalize table, change the **Equalize Duration** setting to the desired time length.

20.2.7. Rectifier Configuration Error

If there is a Configuration Error alarm active, check the rectifier settings.

1. Go to **System > DC System > Inventory > Rectifiers > Configuration**.
2. Check the OVP threshold. It must be set higher than any system Equalize, Boost, Absorption or System Voltage settings. The exact margin required depends on the type of rectifiers, but 48V rectifiers required at least 1V.
3. Check that System Float Voltage, Equalize Voltage, Boost Voltage and the OVP Threshold are set within the ranges supported by the rectifiers on your site.
4. Try setting rectifier configuration to the defaults.
5. Check the rectifier manual information about setting ranges.
6. Save any changes. It may take several seconds for the changes to take affect.

20.2.8. Rediscovering CAN Devices

If all of the installed equipment doesn't display after maintenance it may be caused by defective CAN bus cables or sequencing of removal and replacement of equipment with the controller powered down removed.

1. Check that all CAN bus cables are installed and terminated.
2. Power-cycle CAN devices if possible.
3. Update device firmware if needed.

20.2.9. Replacing a Defective ADIO

When an ADIO fails and/or is permanently removed, the system generates an alarm. The alarm is cleared by removing the device from the inventory. To remove the device from the inventory do the following:

1. Remove the defective ADIO device.
2. Install the new ADIO device and connect all the wires to the same terminals.
3. Go to **Modules** and click the more details icon in the row of the ADIO being replaced.
4. In the **Configuration** table, click the edit icon on the row, Replace with Selected ADIO.
5. In the drop-down menu select the new ADIO and click **Save**.
6. Click the **Replace** button. The new ADIO is now set up with all the mapping from the old ADIO.
7. Check and update any other configuration parameters where required.

20.2.10. Troubleshooting a Battery Test

Calculations for SOH, SOC, RTR Battery Test algorithm used by the CXCHP are designed to work with lead acid batteries which have a Peukert exponent between 1.0 and 2.0. Check your battery manufacturers' specifications to ensure that the battery is within these constraints. When a battery is new, and fully charged, a battery test should show the battery to have 100% **Estimated State of Charge** and 100% or more **Estimated Battery Health**. If it does not, check and correct the following:

1. Is the Battery properly connected?
 - a. Check the wiring between the battery, shunts and the rectifiers.
 - b. Check that the shunts are properly connected and sized.
2. Is the configuration correct?
 - a. Go to **System > System Functions > Battery Runtime and Health Estimation**. Confirm that **Battery Estimation** is **Enabled**, the **Load Model** is correct for your system, and the **Battery LVD** value is correct.
 - b. Go to **System > Inventory > Battery**. Click the more details icon and confirm that the **Capacity Rating** and the **Peukert Exponent** are correct.
 - c. Go to **System > System Functions > Battery Test**. Check that the **Battery Test Timeout** is not too short. For the greatest accuracy set it so that the battery reaches an 80% depth of discharge. Check that the **Battery Test Termination Voltage** is realistic. It should be LVD + 1Volt: for example, a 24V system would be 22.0V.
3. Did anything unexpected happen during the test?

- a. Was the load changed?
 - b. Did the AC power go out?
 - c. Was the controller restarted? Go to **Controller > Controller Status** and check the **Time Since Restart**.
4. Is the **Battery on Discharge** alarm active? During a discharge, it is normal to see the **Battery on Discharge** alarm activate. This alarm activates when the battery voltage is below the **System > Inventory > Battery String > Configuration > Open Circuit Voltage** value **AND** the battery current is below **System > Inventory > Battery String > Charging/Discharging Thresholds > Discharging Threshold** value.

If you corrected anything from the above list, allow the batteries to fully recharge (at least 24-hours), and then run the battery test again. If a battery test shows **Estimated Battery Health** to be 80% or less the batteries should be replaced.

20.2.11. Troubleshooting Power Save

If **Power Save** is either **Stopped** or **Suspended** it may be due to the following conditions. Please review the table below for possible causes and solutions. From the web interface go to **System > DC System > System Functions > Power Save**.

Table 5. Troubleshooting Power Save

Issue	Possible Cause	Solution
Power Save status is: Stopped - All Modules Failed, In Foldback or Unsupported	Units are not supported for power save, high temperature, low AC input voltage	Replace failed rectifiers. Wait for temperature to drop. For universal input rectifiers operating at 120VAC nominal input voltage, power save cannot be used and should be disabled. These units typically can only be loaded to around 50%, due to low input voltage derating so power save has no beneficial effect.
Power Save status is: Stopped - Total Load Current Invalid	Incorrect configuration of load current; lost communication with rectifiers	Check configuration of loads and shunts. Restore rectifier communication.
Power Save status is: Suspended	AC fail or battery test	Restore AC. Wait for battery test to complete.
Power Save status is: Stopped - System Voltage Invalid	ADIO communication lost or incorrect system voltage configuration	Check ADIO communication and restore. Check system voltage configuration.
Power Save status is: Stopped - Bat-	Battery charge limit not configured	Configure battery charge current limit.

Issue	Possible Cause	Solution
tery Charge Current Limit Invalid		
Power Save status is: Stopped - Invalid Data	Data essential to power save cannot be computed.	Check all of the above.
Not enough modules are on and/or battery is discharging	Module Power For Maximum Efficiency setting is above the maximum possible power achievable	Check the values for current and power capacity under Rectifiers > Configuration . These values limit the maximum output power achievable by the rectifier and should be set to 100%.

20.3. Troubleshooting an Inverter System

Incorrect System Configuration

If the system has been incorrectly configured with the wrong number of phases, the commissioning wizard will need to be executed again.

If the number of **DC Groups** is incorrect, it is likely that some inverters have the incorrect DC group number. It is possible to fix this by manually changing the DC group number in the details screen of each inverter.

If the number of shelves per phase is incorrect, it is likely that some inverters have the wrong bay, shelf or slot ID. It is possible to fix this by manually changing these values in the details screen of each inverter.

The details screen for an inverter can be found at **System > Inverter System > Inventory > Inverters > Status**. Click the more details icon for the inverter of interest.

 **Warning:** Executing the commissioning wizard will turn off the inverters and will require them to be unplugged! The system must be bypassed or the load taken off line.

20.3.1. Wrong Inverter AC Input Group

An inverter's AC input group number is set automatically to the same value as the output phase number. It may take a minute or two for the number to be reflected on the user interface. If this number seems incorrect, unplug the inverter, wait for the fan to stop turning and then reinsert it.

20.3.2. Wrong Inverter DC Input Group

The DC input group number is set automatically during commissioning, based on the configured number of DC groups as well as the slot ID. If this number seems incorrect, it can be changed from the details screen of the inverter.

20.3.3. T2S Expert Operations

To thoroughly troubleshoot an inverter system, there are some expert operations that a user may need.

⚠ Warning: *These operations are not normally needed during operation of an inverter system. They should only be used by qualified technicians or under the guidance of technical support (www.alpha.ca/support).*

These expert operations are:

- **Get Configuration File from T2S**
- **Upload Configuration File to Controller**
- **Send Uploaded Configuration File to the T2S**
- **Get Log file from T2S**
- **Clear History Log**
- **Turn Off Inverters**
- **Turn On Inverters**
- **Configuration Helper**

20.3.4. Troubleshooting and Clearing the System Error Alarm

Occasionally the inverter system will activate a **System Error** alarm. This may happen after momentary AC outages, breaker trips, false communication problems or other unusual events. The **System Error** alarm is a reminder to check the T2S log file. It is recommended to download and view the log file for any possible problems. Downloading the log file will also clear the alarm.

To check the T2S log file:

1. Determine which T2S is the source of the alarm. Navigate to **System > Inverter System > Live Alerts** and look for the Check Log File alarm in the list. Whenever the Check Log File alert is active, the System Error alarm will also be active. The Check Log File alert will be shown with the serial number of the T2S that is causing the alert.
 2. Go to **System > Inverter System > Inventory > T2Ss** and click on the details icon of the T2S identified in the previous step.
 3. In the T2S Expert Operations table click the **Get Log File from T2S** button. This will initiate a transfer of the log file from the T2S.
 4. Once the log file has been received, click **Download** to save the file to your computer.
 5. Open the file and look for any event entries that might indicate a persistent issue. For example, module failures or communication problems. These problems may indicate the need to replace a module or inspect communication wiring.
- Once the log file has been transferred from the T2S, the **System Error** alarm will clear.

20.3.5. Phase Saturation Alarm

The **Phase Saturation** alarm indicates that one or more phases are drawing too much power. The alarm activates when the ratio of actual output power, over the total installed power (excluding redundant inverters), exceeds the **Saturation Alarm Threshold** parameter configured on the T2S controller. This value is normally set to 100%. To verify the threshold value download the T2S configuration:

To check the **T2S Saturation Threshold**:

1. Go to **System > Inverter System > Inventory > T2Ss** and click the details icon of the T2S identified in the previous step.
2. In the **T2S Expert Operations** table click **Get Configuration File from T2S**. This will initiate a transfer of the configuration file from the T2S.
3. Once the file has been received, click **Download** to save the file to your computer.
4. Open the file in a text editor and search for "Saturation alarm threshold". The search should find a line similar to: ";556; ;Saturation alarm threshold ; ;80; ;%";. The value 80 indicates the threshold is 80%.
5. If required, this value can be changed. The recommended value is 100. Change the value directly in the text editor and save. Ensure that only the value is changed and the enclosing semi-colons are preserved.
6. Return to the controller interface and click **Upload Configuration File to Controller** in the **T2S Expert Operations** table.
7. Select the T2S configuration file that was just edited, and then click **Upload**.
8. In the **T2S Expert Operations** table, the **Send To T2S**. Wait for the transfer to complete.

20.4. Troubleshooting a Line Power System

This section describes to how to troubleshoot LP system alarms, overload and transient events.

20.4.1. Resolving Line Power System Alarms

Some of the alarms from the line power system are generated by the LPS modules. These alarms are Input Voltage High/Low Shutdown, High Temperature Shutdown, Temperature Warning, Module Connection Error and any alarm with "Channel" in its name. This section describes how to identify the module causing the alarm.

1. When one of the line power systems mentioned above is active, go to **System > Line Power System > Layout**.
2. On the **Layout** screen look for a module outlined in red, or a channel with the red exclamation mark icon that signifies a channel alert. The table shows the physical location of the module to help find it, should it need to be replaced.
3. Click the channel with the alert icon. If the module is outlined in red, but no channels appears to be in alert, click any channel.
4. The channel details display in another table.
5. Click the link to show the module details.

6. In the **Alerts** table, sort on the **Value** column to show all the active alerts at the top. This identifies all the alerts that are active on the module. Use the help text for the alerts to decide on the corrective action.

20.4.2. Fan Tray Alarms

The LP System may be installed with one or more optional fan trays. The fan tray is a CAN connected device that has a **Fan Fail** alarm associated with it. This section describes how to identify the module causing the alarm.

1. Go to **Alarms > Active Alarms**.
2. In the **Active Alarms** table, find the **Fan Fail Alarm** and note the name of the fan tray that is responsible. This confirms the alarm is caused by the fan tray and not some other device.
3. Look for the physical fan tray with the red LED. Repair or replace as required.

20.4.3. Line Power System Overload

If the line power system is overloaded, one or more modules will start flashing the front panel LEDs yellow. Eventually the input voltage low alarm may be activated if it is configured and enabled.

If this occurs it may be necessary to add more capacity at the input to the LP system, reduce the power drawn by the remote load or add more line power modules.

20.4.4. Line Power System Transient Events

Depending on circumstances a remote load may experience a brown-out or momentary loss of power. This is sometimes caused by a channel that has had a transient low output voltage, ground fault or over-voltage protection shutdown. Since these transients occur too quickly to trigger an alarm they are instead logged to the module alert log. After a suspected transient event:

1. Go to **Logs > Events and Alerts** and view the Module Alerts table.
2. In the **Search** box, type "transient". The table now shows only the transient events that have occurred. If the table is empty then no transients were detected.
3. Each entry for a transient event shows the serial number of the module responsible. Note the serial number.
4. Go to **System > Line Power System > Inventory > Line Power Modules** and type the serial number of the module in the **Search** box. All other modules should now be filtered out leaving only the module of interest.
5. Use the **Locate** button to visually identify the module in the rack.
6. Depending on the type of transient event detected, it may be necessary to unplug and insert the module to ensure it is fully seated, replace the module or check and fix any channel connections.

21. CXC HP Reference Guide

The following section is a reference guide for the controller software.

21.1. Modules

This section serves as a reference to the CXC HP modules, see [Table 6 \(on page 260\)](#).

Table 6. Support for CAN Modules

Category	Device Name	CXC HP Support
ADIO	L-ADIO	v2.00
ADIO	6I-ADIO	v2.00
ADIO	Shunt Multiplexer	v2.00 ¹
ADIO	I/M1 ADIO	v2.20
ADIO	PSU ADIO	v2.20
ADIO	HV-ADIO	v3.00
ADIO	8R8D ADIO	v3.10
ADIO	4R8D ADIO	Not Planned ²
ADIO	12V BCM	Not Planned
ADIO	2V BCM	Not Planned
ADIO	BDFB VI Meter	v3.10
ADIO	LPS Fan Tray	v3.20
ADIO	Smart E2	v4.00
Rectifier	Cordex HP 250W 12Vdc	v2.10
Rectifier	Cordex 400W 24Vdc	v2.00
Rectifier	Cordex 3.1kW 24Vdc	v2.00
Rectifier	Cordex HP 300W 48Vdc	TBD
Rectifier	Cordex 650W 48Vdc	v2.00
Rectifier	Cordex 1kW 48Vdc	v2.00
Rectifier	Cordex HP 1.2kW 48Vdc	v2.00

1. The shunt multiplexer can be monitored by the CXC HP but it cannot be calibrated by the CXC HP.
2. The 4R8D ADIO is not officially supported. If you connect one to the CXC HP, it will show up as an 8D8R ADIO. All eight digital inputs will function correctly. The first four relays will function correctly and are mapped to the four physical relays on the 4R8D ADIO.

Category	Device Name	CXC HP Support
Rectifier	Cordex 1.8kW 48Vdc	v2.00
Rectifier	Cordex HP 2.0kW 48Vdc	v2.00
Rectifier	Cordex HP 2.4kW 48Vdc	v2.00
Rectifier	Cordex HP 3.0kW 48Vdc	v6.00
Rectifier	Cordex 3.6kW 48Vdc	v2.00
Rectifier	Cordex HP 4.0kW 48Vdc	v2.00
Rectifier	Cordex HP 12kW 48Vdc	v2.11
Rectifier	Cordex HP 12kW v2 48Vdc	v6.00
Rectifier	Cordex 3.3kW 65Vdc	Not Planned
Rectifier	Cordex 1.1kW 125Vdc	v3.00
Rectifier	Cordex 1.1kW 220Vdc	v3.00
Rectifier	Cordex 4.4kW 125Vdc	v3.00
Rectifier	Cordex 4.4kW 220Vdc	v3.00
Converter	CXDF 24-48/2kW	v2.01
Converter	CXDF 48-24/2kW	v2.01
Sub-controller	T2S	v3.00
Inverter	AIM 1500	TBD
Inverter	AIM 2500	v3.00
Inverter	TUS	v3.10
Line Powering	LPS36	v3.20
Line Powering	eLimiter+	v3.20
FXM	FXM-ADIO	v6.00
ADIO	XMBS Smart Bypass	v6.20

21.2. Communication Ports

There are three sets of ports that are used for controller communication.

- Two Ethernet ports, commonly referred to as the front and rear Ethernet ports.
- Two USB ports, commonly referred to as the front and rear USB ports.
- Two CAN ports, commonly referred to as CAN1 and CAN2.

21.2.1. Ethernet Ports

The Ethernet ports support a standard RJ45 connection and can run at 10 Base-T or 100 Base-T speeds with auto MDI-X detection (Medium Dependent Interface crossover detection) to eliminate the need for cross-over cables.

The Ethernet ports support the IPv4 and IPv6 protocols. The IPv4 protocol supports both static IP (Internet Protocol) and DHCP (Dynamic Host Configuration Protocol) configuration. The IPv6 protocol will configure a link-local address automatically. Addresses with other scopes are configured by Router Advertisements (RA). Both the LCD touchscreen, and CXC HP web interface will display the full list of IPv6 addresses that have been configured for each port.

You can also use IPv6 addresses for outgoing messages including email servers and SNMP destinations. SNTTP does not support IPv6 at this time.

The CXC HP does not register itself with DNS (Domain Name System) servers nor can it be configured to join a domain or work group. However, the CXC HP is capable of using a DNS server to resolve domain names if the gateway is set up to allow that.

⚠ Warning: *While there are two Ethernet ports available on the CXC HP, it is recommended that they are not both connected to the same network. There is a concern that network management systems and higher level control systems will see the CXC HP as two devices and get duplicate notifications (e.g. SNMP traps) for a single device.*

21.2.2. USB Ports

The USB ports support a standard, full-size USB host connection.

In this release, only USB Mass Storage (UMS) devices that have been formatted with a FAT32 (File Allocation Table) file system are fully supported for use in the USB ports. USB drives with the NTFS (New Technology File System) file system will not work.

21.2.3. CAN Ports

Introduction to CAN for the CXC HP

CAN is used by the CXC HP to discover, collect data from, control and configure the power modules and input/output (ADIO) modules in the power system. The CXC HP has two up to CAN buses, each of which can control up to 127 power and ADIO modules.

What is a CAN bus?

A Controller Area Network (CAN) refers to a network of devices that communicate using the CAN serial protocol to support distributed real-time control. The CAN bus standard was developed by Bosch and Intel and has been in use since 1990.

How do CAN bus modules communicate?

A CAN bus uses two dedicated wires for communication called CAN high and CAN low. When the CAN bus is idle, both lines carry 2.5V. When data bits are being transmitted, the CAN high line goes to 3.75V and the CAN low drops to 1.25V, thereby generating a 2.5V difference between the lines. Since communication relies on a voltage difference between the two bus lines, the CAN bus is insensitive to

inductive spikes, electrical fields or other noise. This makes CAN bus a reliable choice for networked communications in electrically noisy environments.

Figure 107. CAN Differential Signaling

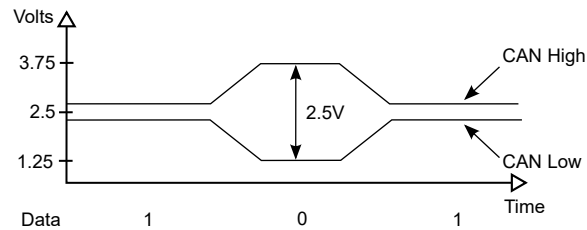

CAN Network Topology

A CAN network uses a twisted pair cable to transmit the differential signals, terminated at both ends with 120 Ohm Resistors.

Figure 108. CAN Network Topology

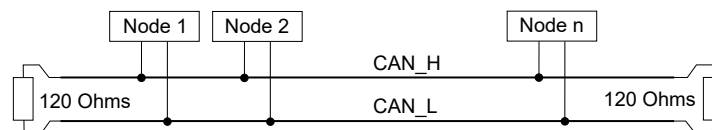

What is CAN Power?

CAN power can be supplied through CAN bus. Optionally a power supply for the CAN bus modules can be arranged separately. The power supply wiring can be either totally separate from the CAN bus lines using two, two-wire cables or it can be combined with the CAN bus lines into a single four-wire cable. CAN bus cabling is available from multiple vendors.

How are Alpha CAN Cables Wired?

The CAN connector used by Alpha Technologies is a 6P6C Offset Latch Modular Connector. These connectors have gender and the male connectors are called plugs and the female connectors are called jacks. You may also hear these connectors referred to by their Registered Jack (RJ) equivalent: RJ11, RJ14 and RJ25 are all physically compatible with 6P6C modular connectors. The figure below shows the CAN pinout for a 6P6C Offset Latch Modular Plug. Pins 1 & 6 are used for CAN power while pins 2 & 4 are used for CAN signaling.

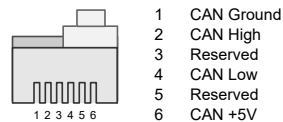
Figure 109. Alpha CAN Connector**Are there distance limitations?**

The electrical characteristics of a typical CAN bus cable restrict the cable length. Alpha Technologies Ltd. recommends having no more than one long CAN cable on a CAN bus and to restrict the length of that long cable to less than 100 meters.

Is the number of nodes (modules) limited?

CAN allows up to 127 modules per bus.

Where can I get more information about CAN?

CAN is specified by the International Standards Organization (ISO) standard ISO 11898.

21.3. Default System Values and Ranges

The following section provides tables of the default values and ranges for supported systems.

21.3.1. 12V System Default Values and Ranges

This section provides a reference table for the default values and ranges for a 12V system.

Table 7. 12V System Default Values

Setting Name	Default	Minimum	Maximum
Allowed Voltage Range		10.5	15.0
Float Voltage	13.5	11.875	14.55
Equalize Voltage	13.75	12.45	15.05
Boost Voltage	13.75	12.45	15.05
Rectifier - Minimum Test Voltage	11.0		
Safe Voltage	12.85	11.5	14.0
Over Voltage Protection	14.25	12.125	15.75
Absorption Voltage	13.75	12.45	14.75
Absorption Arming Voltage	12.0	10.5	13.25
Temp Comp Max Voltage	13.875		14.5

Setting Name	Default	Minimum	Maximum
Temp Comp Min Voltage	13.125	11.875	
Battery String Number of Cells	6	1	200
Temp Comp Voltage Warning	0.25	0	0.25
Battery Test Termination Voltage	11.125	11.125	15.0
Output Voltage High Alarm	13.875	10.50	15.00
Output Voltage Very High Alarm	14.125	10.50	15.00
Output Voltage Low Alarm	12.0	10.50	15.00
Output Voltage Very Low Alarm	11.625	9.00	15.00

21.3.2. 24V System Default Values and Ranges

This section provides a reference table for the default values and ranges for a 24V system.

Table 8. 24V System Default Values

Setting Name	Default	Minimum	Maximum
Allowed Voltage Range		21.0	30.0
Float Voltage	27.0	23.75	29.1
Equalize Voltage	27.5	24.9	30.10
Boost Voltage	27.5	24.9	30.10
Rectifier - Minimum Test Voltage	22.0		
Safe Voltage	25.7	23.0	28.0
Over Voltage Protection	28.5	24.25	31.5
Absorption Voltage	27.5	24.9	29.5
Absorption Arming Voltage	24.0	21.0	26.5
Temp Comp Max Voltage	27.75		29
Temp Comp Min Voltage	26.25	23.75	
Battery String Number of Cells	12	1	200
Temp Comp Voltage Warning	0.5	0	0.5
Battery Test Termination Voltage	22.25	22.25	26.0
Output Voltage High Alarm	27.75	21.00	30.00
Output Voltage Very High Alarm	28.25	21.00	30.00

Setting Name	Default	Minimum	Maximum
Output Voltage Low Alarm	24.0	21.00	30.00
Output Voltage Very Low Alarm	23.25	18.00	30.00

21.3.3. 48V System Default Values and Ranges

This section provides a reference table for the default values and ranges for a 48V system.

Table 9. 48V System Default Values

Setting Name	Default	Minimum	Maximum
Allowed Voltage Range		42.0	60.0
Float Voltage	54.0	47.5	58.2
Equalize Voltage	55.0	49.8	60.2
Boost Voltage	55.0	49.8	60.2
Rectifier - Minimum Test Voltage	44.0		
Safe Voltage	51.4	46.0	56.0
Over Voltage Protection	57.0	48.5	63.00
Absorption Voltage	55.0	49.8	59.0
Absorption Arming Voltage	48.0	42.0	53.0
Temp Comp Max Voltage	55.5		58.0
Temp Comp Min Voltage	52.5	47.5	
Battery String Number of Cells	24	1	200
Temp Comp Voltage Warning	1.0	0	1.0
Battery Test Termination Voltage	44.5	44.5	52.0
Output Voltage High Alarm	55.5	42.00	60.00
Output Voltage Very High Alarm	56.5	42.00	60.00
Output Voltage Low Alarm	48.0	42.00	60.00
Output Voltage Very Low Alarm	46.5	36.00	60.00

21.3.4. 125V System Default Values and Ranges

This section provides a reference table for the default values and ranges for a 125V system.

Table 10. 125V System Default Values

Setting Name	Default	Minimum	Maximum
Allowed Voltage Range		90.0	160.0
Float Voltage	140.625	90.0	160.0
Equalize Voltage	143.23	90.0	160.0
Boost Voltage	143.23	90.0	160.0
Rectifier - Minimum Test Voltage	114.58	90.0	160.0
Safe Voltage	133.85	90.0	160.0
Over Voltage Protection	151.04	90.0	160.0
Absorption Voltage	143.23	90.0	160.0
Absorption Arming Voltage	125.0	90.0	160.0
Temp Comp Max Voltage	144.53		160.0
Temp Comp Min Voltage	136.72	90.0	
Battery String Number of Cells	63	1	200
Temp Comp Voltage Warning	2.60	0	2.60
Battery Test Termination Voltage	115.89	90.0	160.0
Output Voltage High Alarm	144.53	90.0	160.0
Output Voltage Very High Alarm	147.14	90.0	160.0
Output Voltage Low Alarm	125.0	90.0	160.0
Output Voltage Very Low Alarm	121.09	93.75	160.0

21.3.5. 220V System Default Values and Ranges

This section provides a reference table for the default values and ranges for a 220V system.

Table 11. 220V System Default Values

Setting Name	Default	Minimum	Maximum
Allowed Voltage Range		180.0	320.0
Float Voltage	247.50	180.0	320.0
Equalize Voltage	252.08	180.0	320.0
Boost Voltage	252.08	180.0	320.0
Rectifier - Minimum Test Voltage	201.67	180.0	320.0

Setting Name	Default	Minimum	Maximum
Safe Voltage	235.58	180.0	320.0
Over Voltage Protection	265.83	180.0	320.0
Absorption Voltage	252.08	180.0	320.0
Absorption Arming Voltage	220.0	180.0	320.0
Temp Comp Max Voltage	254.38		320.0
Temp Comp Min Voltage	240.63	180.0	
Battery String Number of Cells	110	1	200
Temp Comp Voltage Warning	4.58	0	4.58
Battery Test Termination Voltage	203.96	180.0	320.0
Output Voltage High Alarm	254.38	180.0	320.0
Output Voltage Very High Alarm	258.96	180.0	320.0
Output Voltage Low Alarm	220.0	180.0	320.0
Output Voltage Very Low Alarm	213.13	165.0	320.0

21.3.6. AC Voltage Alarm Ranges

This table provides the AC voltage alarm ranges.

Table 12. AC Voltage Alarm Ranges

Setting Name	Default	Minimum	Maximum
AC Volts High Alarm	270.0	60.0	550.0
AC Volts Low Alarm	180.0	60.0	550.0
AC Volts Alarm Hysteresis	3.0		

22. Certification

CSA (Canadian Standards Association also known as CSA International) was established in 1919 as an independent testing laboratory in Canada. CSA received its recognition as an NRTL (Nationally Recognized Testing Laboratory) in 1992 from OSHA (Occupational Safety and Health Administration) in the United States of America (Docket No. NRTL-2-92). This was expanded and renewed in 1997, 1999, and 2001. The specific notifications were posted on OSHA's official website as follows:

- Federal Register #: 59:40602 - 40609 [08/09/1994]
- Federal Register #: 64:60240 - 60241 [11/04/1999]
- Federal Register #: 66:35271 - 35278 [07/03/2001]

When these marks appear with the indicator “C and US” or “NRTL/C” it means that the product is certified for both the US and Canadian markets, to the applicable US and Canadian standards. (1)

Alpha rectifier and power system products, bearing the aforementioned CSA marks, are certified to CSA C22.2 No. 60950-01 and UL 60950-1. Alpha UPS products, bearing the aforementioned CSA marks, are certified to CSA C22.2 No. 107.3 and UL 1778. As part of the reciprocal, US/Canada agreement regarding testing laboratories, the Standards Council of Canada (Canada's national accreditation body) granted Underwriters Laboratories (UL) authority to certify products for sale in Canada. (2) Only Underwriters Laboratories may grant a license for the use of this mark, which indicates compliance with both Canadian and US requirements.(3)



NRTL's Capabilities

NRTLs are third party organizations recognized by OSHA, US Department of Labor, under the NRTL program. The testing and certifications are based on product safety standards developed by US based standards developing organizations and are often issued by the American National Standards Institute (ANSI). (4) The NRTL determines that a product meets the requirements of an appropriate consensus-based product safety standard either by successfully testing the product itself, or by verifying that a contract laboratory has done so, and the NRTL certifies that the product meets the requirements of the product safety standard. (4)

Governance of NRTL

The NRTL Program is both national and international in scope with foreign labs permitted.

(1) www.csagroup.org • (2) www.scc.ca • (3) www.ulc.ca • (4) www.osha.gov

23. Glossary

AC	Alternating Current
ACCT	Alternating Current Current Transducer
ADIO	Analog-digital input-output
Alarm	An alarm has user configurable fields like a name, priority and it can is able to sent SNMP or email notifications when it becomes active or cleared
ALCO	Alarm cutoff
Alert	An alert is status information about a module like a converter or rectifier. For example, "Module Fail" or "Current Limit"
CAN	Controller Area Network
CT	Current Transducer
CX	Cordex series; e.g. CXC for Cordex™ System Controller
CXC	Cordex™ Controller
CXC HP	Cordex™ Controller High Performance
CXD	Cordex™ DC-DC Converter
CXR	Cordex™ Rectifier
DC	Direct current
DCCT	Direct Current Current Transducer
DHCP	Dynamic Host Configuration Protocol
DOD	Depth of discharge
FCC	Federal Communications Commission
GUI	Graphical User Interface
Hint	A hint is information about the state of the system or possible configuration problems.
ICMP	Internet control message protocol
IEC	International Electrotechnical Commission
IETF	Internet Engineering Task Force
IP	Internet Protocol
IPv4	Internet Protocol version 4
IPv6	Internet Protocol version 6
ISO	International Organization for Standardization
LCD	Liquid Crystal Display
LED	Light Emitting Diode
LVD	Low voltage disconnect
LVBD	Low voltage battery disconnect

MAC	Media Access Control; e.g. MAC address
MIB	Management Information Base; a database of entities most often associated with SNMP
MOV	Metal Oxide Varistor
MUX	Multiplexer
NEBS	Network Equipment-Building System; a set of safety, spatial and environmental guidelines for telecom
OLED	Organic LED, in-shelf controller display
RFC	Request For Comments; a formal document (or standard) from the Internet Engineering Task Force (IETF)
SCI	Serial Communication Interface
SELV	Safety Extra Low Voltage
SMTP	Simple Mail Transfer Protocol
SNMP	Simple Network Management Protocol
SNTP	Simple Network Time Protocol
SOC	State of Charge
TCP/IP	Transmission Control Protocol / Internet Protocol
Trap	An unsolicited SNMP event notification

