

250/500 Watts Peak

- 250 W Convection-cooled Rating
- 500 W Peak Power
- IT & Medical Safety (BF) Approvals
- U Channel 4" x 7.5" Package
- 80 VAC to 300 VAC Input
- 5 V/1.5A Standby & 12 V/0.6 A Auxiliary
- AC OK Signal, Inhibit
- Current Share
- 3 Year Warranty



Dimensions:

CMP250:
7.50 x 4.00 x 1.57" (190.5 x 101.6 x 39.9 mm)

CMP250-C:
7.89 x 4.12 x 1.92" (200.5 x 104.6 x 48.8 mm)

The universal AC input CMP250 provides up to 500 W peak power and 250 W convection-cooled in a 7.5" x 4" package, over the temperature range -40 °C to +50 °C with derating to +70 °C. Approved for IT and Medical (BF) applications and with a feature set including constant current overload characteristics, a 5 V/1.5 A standby output, 12 V/0.6 A auxiliary, AC OK signal, inhibit, current share the CMP250 is ideal for motors and other electromechanical loads, without the need for fan cooling, in both industrial and medical applications.

Models & Ratings

Output Voltage V1	Output Current V1		Standby Supply V2	Aux. Supply V3	Output Power		Model Number ⁽¹⁾
	Convection	Peak			Convection	Peak ⁽²⁾	
24 V	10.4 A	20.8 A	5.0 V / 1.5 A	12.0 V / 0.6 A	250 W	500 W	CMP250PS24
36 V	6.9 A	13.8 A	5.0 V / 1.5 A	12.0 V / 0.6 A	250 W	500 W	CMP250PS36
48 V	5.2 A	10.4 A	5.0 V / 1.5 A	12.0 V / 0.6 A	250 W	500 W	CMP250PS48

Notes

1. Add suffix '-C' for covered version, e.g. CMP250PS24-C (20% derating applies)
2. Peak current/power available for up to 1 minute. Average power must not exceed 225 W, other peak and average load conditions can be accommodated limited by the thermal considerations and average power rating. Peak power and average power derate below 90 VAC.

Summary

Characteristic	Minimum	Typical	Maximum	Units	Notes & Conditions
Input Range	80	115/230	264	VAC	Derate output power <90 VAC, see fig.1 0.5 seconds max
			300		
No Load Input Power		1.3		W	All models, when optional inhibit activated
Input Frequency	47	50/60	63	Hz	
Power Factor		>0.95			EN61000-3-2 class A compliant EN61000-3-2 class C for loads ≥50%
Input Current - Full Load		5.2/2.6		A	115/230 VAC. 500 W
Inrush Current		30	40	A	Cold start 25 °C, 230 VAC
Earth Leakage Current		100/200	250	µA	Typ. 115/230 VAC 50 Hz, Max 264 VAC 60 Hz
Patient Leakage Current		55	80	µA	
Efficiency		89		%	230 VAC, 250 W
Operating Temperature	-40		+70	°C	See derating curve, fig.8 and Thermal Considerations on page 8
EMC	EN55032/11 Class B Conducted & Radiated, EN61000-3-2, EN61000-3-3				
Safety Approvals	EN62368-1, UL62368-1, CSA C22.2 No. 62368-1, IEC62368-1, IEC60950-1 Ed 2, IEC60601-1 Ed 3 Including Risk Management, ANSI/AAMI ES60601-1:2005 & CSA C22.2, No.60601-1:14				

Input

Characteristic	Minimum	Typical	Maximum	Units	Notes & Conditions
Input Voltage - Operating	80	115/230	264	VAC	Derate output power < 90 VAC. See fig. 1
Input Voltage - Fault Condition			300	VAC	0.5 seconds max
Input Frequency	47	50/60	63	Hz	
Power Factor		>0.95			EN61000-3-2 class A compliant EN61000-3-2 class C for loads $\geq 50\%$
Input Current - Full Load		5.2/2.6		A	115/230 VAC. 500 W
No Load Input Power		1.3		W	All models, when optional inhibit activated
		7.8			CMP250PS24 - 115V AC
		6.4			CMP250PS24 - 230V AC
		6.5			CMP250PS36 - 115V AC
		4.2			CMP250PS36 - 230V AC
		7.0			CMP250PS48 - 115V AC
		6.0			CMP250PS48 - 230V AC
Inrush Current		30	40	A	230 VAC
Earth Leakage Current		100/200	250	μ A	Typ. 115/230 VAC 50 Hz, Max 264 VAC 60 Hz
Input Protection	F10 A/250V internal fuse in both AC lines				

Output

Characteristic	Minimum	Typical	Maximum	Units	Notes & Conditions
Output Voltage	24		48	VDC	See Models and Ratings table
Initial Set Accuracy			± 1	%	50% load, 115/230 VAC
Output Voltage Adjustment			± 10	%	
Minimum Load	0			A	
Start Up Delay		1.0	2.0	s	115/230 VAC full load from input AC turn on
Hold Up Time	20			ms	90 VAC, 250 W
Drift			± 0.2	%	After 20 min warm up
Line Regulation			0.5	%	
Load Regulation			1.0	%	0-100% load
Transient Response			<4	%	Recovery within 1% in less than 500 μ s for a 50-75%-50% load change
Ripple & Noise			1	% pk-pk	20 MHz bandwidth
Overvoltage Protection	115		140	%	Vnom DC. Output 1, recycle input to reset
Overload Protection	205		255	%	Of average power, approx. constant current
Short Circuit Protection					Continuous, no damage
Temperature Coefficient			0.05	%/°C	
Overtemperature Protection					Shut down & auto recovery
Patient Leakage Current		55	80	μ A	

Input Voltage Derating

Figure 1

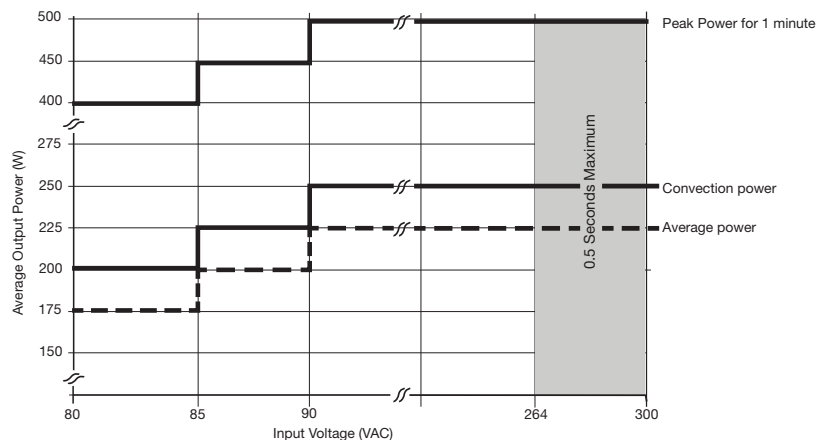

General

Characteristic	Minimum	Typical	Maximum	Units	Notes & Conditions
Efficiency		89		%	230 VAC, 250 W
Isolation: Input to Output Input to Ground Output to Ground	4000			VAC	2 x MOPP
	1500			VAC	1 X MOPP
	1500			VAC	1 X MOPP
Switching Frequency		62-560		kHz	PFC
		59		kHz	Main converter
		50-130		kHz	Standby
Power Density			5.3	W/in ³	At Average Power Rating
Mean Time Between Failure		200		kHrs	MIL-HDBK-217F, Notice 2 +25 °C GB
Weight		2.02 (919)		lb (g)	CMP250PSxx
		2.36 (1072)			CMP250PSxx-C

Efficiency Vs Load

Figure 2
24 V Models

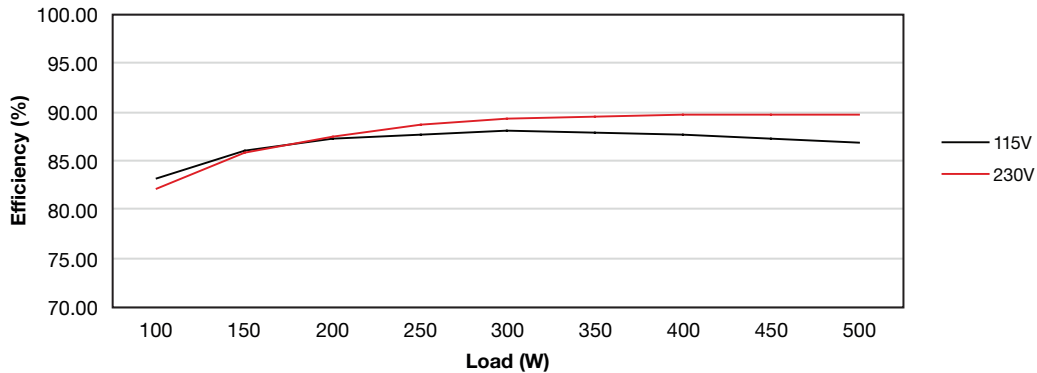

Figure 3
36 V Models

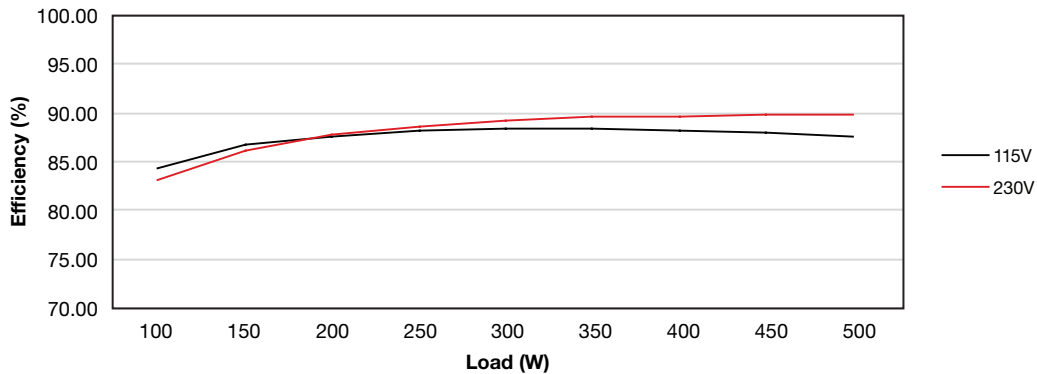
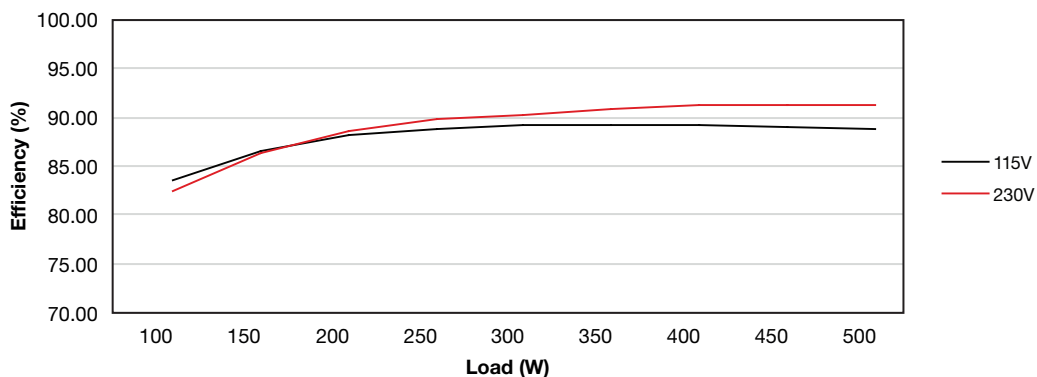

Figure 4
48 V Models



Signals & Controls - Optional

Characteristic	Notes & Conditions
Remote Sense	Compensates for 0.5 V total voltage drop.
5 V Standby Supply (V2)	5V/1.5 A supply, always present when AC supplied, isolated supply.
12 V Aux. (V3)	12V/0.6 A supply, present when AC supplied, inhibit turns supply off. Referenced to V1 return.
AC OK/Power Fail	AC OK is an open collector transistor, referenced to V1 return, providing a minimum of 3 ms warning of loss of output regulation. The transistor is normally on when AC is healthy. See fig. 5.
Inhibit	The inhibit high pin should be pulled below 0.4 V to switch V1 & V Aux (V3) off. Open circuit or 2-8 V maximum to switch the output on. See fig. 6.
Current Share	Connecting pin 9 like voltage units (3 maximum) will force the current to share between the outputs. Units share current within 10% of each other at full load. See fig. 7.

Power Fail

Figure 5

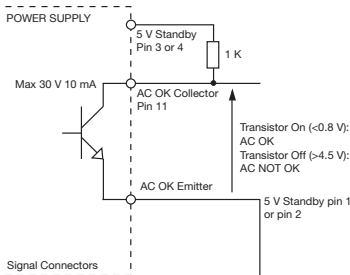

Inhibit (High)

Figure 6

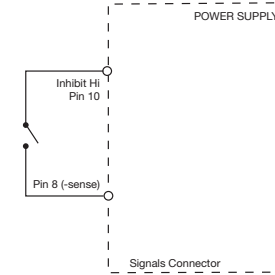

Parallel & Current Share

Figure 7

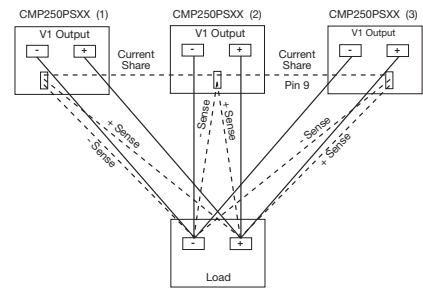

Environmental

Characteristic	Minimum	Typical	Maximum	Units	Notes & Conditions
Operating Temperature	-40		+70	°C	See derating curve, fig.8. and Thermal Considerations on page 8.
Storage Temperature	-40		+85	°C	
Cooling					Convection-cooled
Humidity			95	%RH	Non-condensing
Operating Altitude			5000	m	Information Technology
			4000		Medical
Shock	±3 x 30g shocks in each plane, total 18 shocks. 30g = 11ms (±0.5msec), half sine. Conforms to EN60068-2-27 & EN60068-2-47				
Vibration	Single axis 10 - 500 Hz at 2g sweep and endurance at resonance in all 3 planes. Conforms to EN60068-2-6				

Temperature Derating Curve

Figure 8

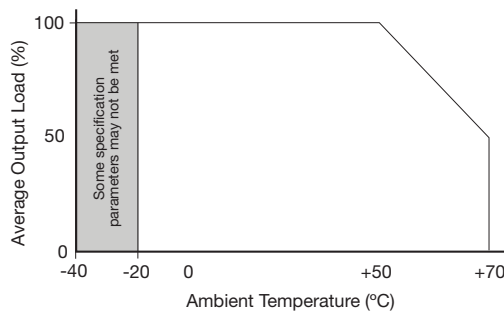

EMC: Emissions

Phenomenon	Standard	Test Level	Notes & Conditions
Conducted	EN55032/11	Class B	
Radiated	EN55032/11	Class A	
		Class B	With 2 turns Würth 742 712 22 core or similar on AC input cable
Harmonic Current	EN61000-3-2	Class A	All models
		Class C	≥50% load
Voltage Fluctuations	EN61000-3-3		

EMC: Immunity

Phenomenon	Standard	Test Level	Criteria	Notes & Conditions
Medical Device EMC	IEC60601-1-2	Ed.4.0:2014	as below	
Low Voltage PSU EMC	EN61204-3	High severity level	as below	
Radiated	EN61000-4-3	3	A	
ESD	EN61000-4-2	4	A	±8 kV contact, ±15 kV air
EFT	EN61000-4-4	3	A	
Surges	EN61000-4-5	Installation class 3	A	
Conducted	EN61000-4-6	3	A	
Magnetic Field	EN61000-4-8	4	A	
Dips and Interruptions based on 250 W output load	EN55024 (100 VAC)	Int >95% (0 VAC), 8.3ms	A	
		Dip 30% (70 VAC), 416ms	B	
		Int >95% (0 VAC), 4160ms	B	
	EN55024 (240 VAC)	Int >95% (0 VAC), 10.0ms	A	
		Dip 30% (168 VAC), 500ms	B	
		Int >95% (0 VAC), 5000ms	B	
	EN60601-1-2 (100 VAC)	Int >95% (0 VAC), 10.0ms	A	
		Dip 100% (0 VAC), 20ms	A	
		Dip 60% (40 VAC), 100ms	A	Derate output power to 85 W
		Dip 30% (70 VAC), 500ms	A	
	EN60601-1-2 (240 VAC)	Int >95% (0 VAC), 5000ms	B	
		Int >95% (0 VAC), 10.0ms	A	
		Dip 100% (0 VAC), 20ms	A	
		Dip 60% (96 VAC), 100ms	A	
Dip 30% (168 VAC), 500ms		A		
		Int >95% (0 VAC), 5000ms	B	

Safety Approvals

Safety Agency	Safety Standard	Notes & Conditions
CB Report	IEC60950-1 Ed 2	Information Technology
	IEC62368-1 Ed 2	Information Technology
	IEC60601-1 Ed 3 Including Risk Management	Medical
UL	UL62368-1, CSA C22.2 No. 62368-1	Information Technology
	ANSI/AAMI ES60601-1:2005 & CSA C22.2, No.60601-1:14	Medical
TUV	EN62368-1	Information Technology
	EN60601-1	Medical
CE	LVD & RoHS	
Equipment Protection Class	Class I	See safety agency conditions of acceptability for details

Means of Protection		Category
Primary to Secondary	2 x MOPP (Means of Patient Protection)	IEC60601-1 Ed 3
Primary to Earth	1 x MOPP (Means of Patient Protection)	
Secondary to Earth	1 x MOPP (Means of Patient Protection)	

Mechanical Details

CMP250PSxx

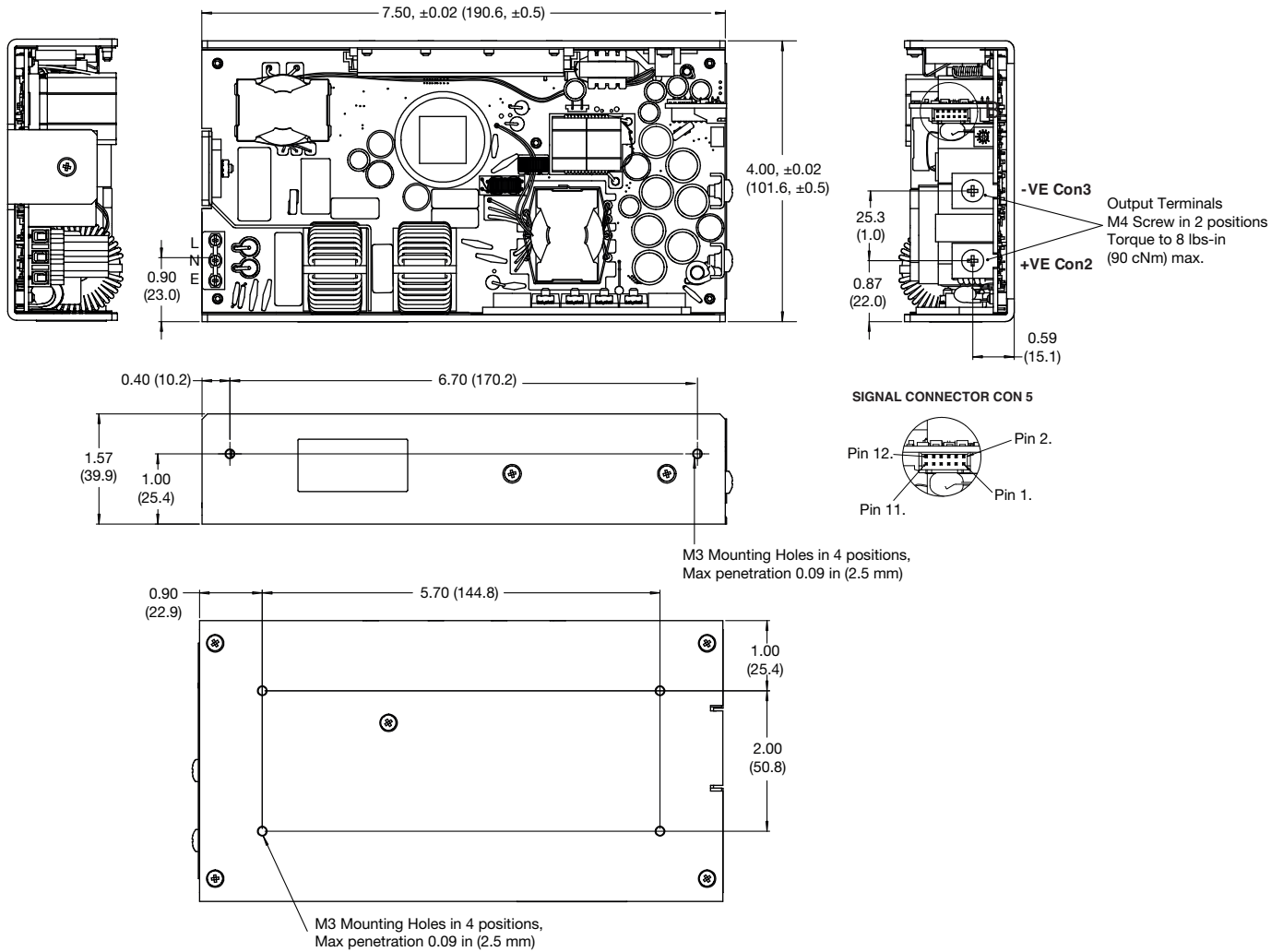

Input Connector CON1	
Pin	Function
1	Line
2	Neutral
3	Earth

Output Connector	
CON2	+V1
CON3	-V1

Signals Connector CON5	
1	-VE Standby V2
2	-VE Standby V2
3	+VE Standby V2
4	+VE Standby V2
5	+VE Aux. V3
6	-VE Aux. V3
7	+VE Sense, V1
8	-VE Sense, V1
9	Current Share
10	Inhibit
11	Power Fail
12	N/C

Notes

1. Dimensions shown in inches (mm).

Mechanical Details

CMP250PSxx-C (Covered)

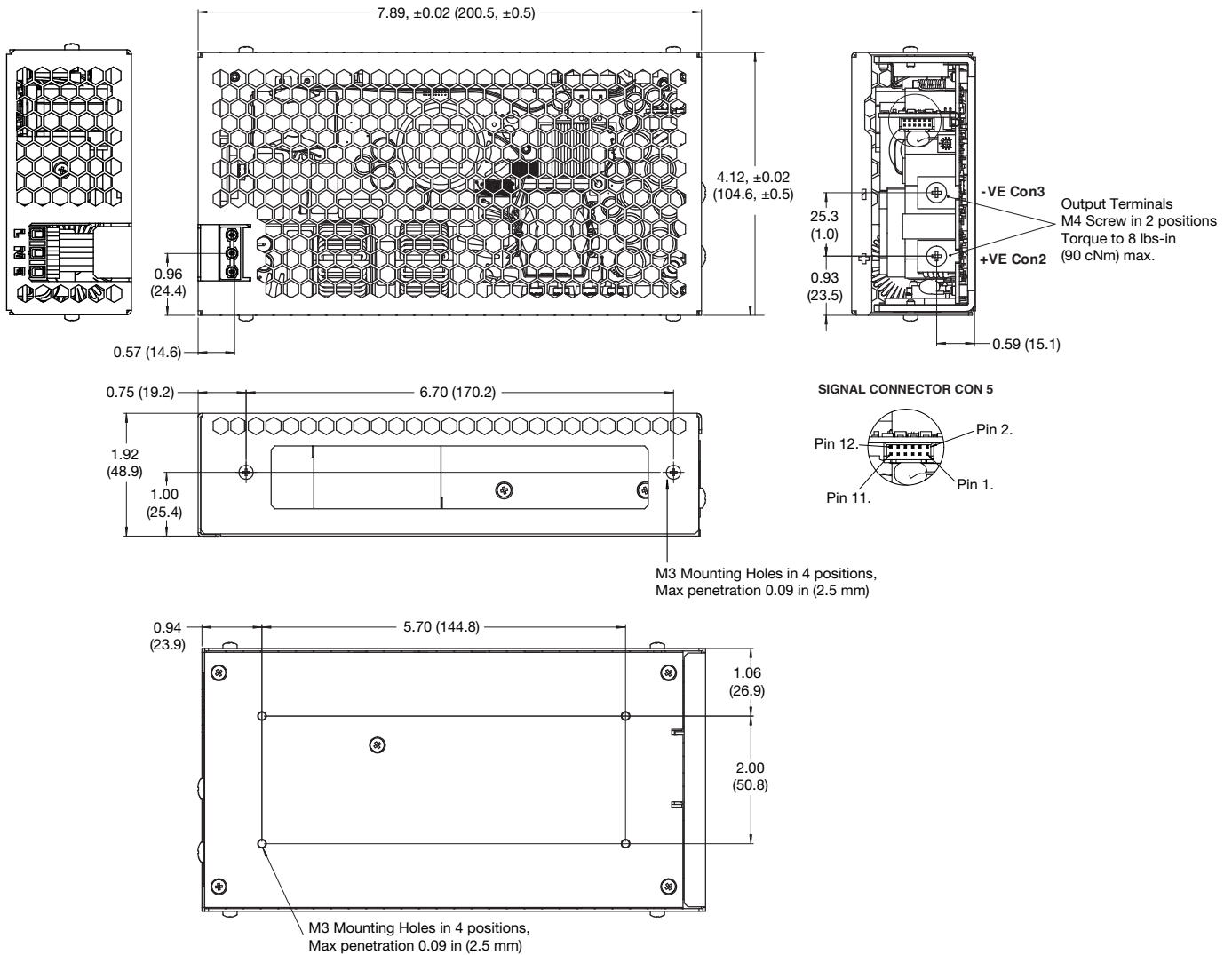

Input Connector CON1	
Pin	Function
1	Line
2	Neutral
3	Earth

Output Connector	
CON2	+V1
CON3	-V1

Signals Connector CON5	
1	-VE Standby V2
2	-VE Standby V2
3	+VE Standby V2
4	+VE Standby V2
5	+VE Aux. V3
6	-VE Aux. V3
7	+VE Sense, V1
8	-VE Sense, V1
9	Current Share
10	Inhibit
11	Power Fail
12	N/C

Notes

1. Dimensions shown in inches (mm).

Thermal Considerations

In order to ensure safe operation of the PSU in the end-use equipment, the temperature of the components listed in the table below must not be exceeded. Temperature should be monitored using K type thermocouples placed on the hottest part of the component (out of direct air flow). See below for component locations.

Temperature Measurements (At Ambient 50 °C)	
Component	Max Temperature °C
PFC1 Coil	120 °C
T1 Coil	120 °C
C5	105 °C
C3	105 °C
BR1	130 °C
L12	130 °C
L13	130 °C

Service Life

The estimated service life of the CMP250 Series is determined by the cooling arrangements and load conditions experienced in the end application. Due to the uncertain nature of the end application this estimated service life is based on the actual measured temperature of a key capacitors within the product when installed in the end application. The worst case of the two figures below should be taken as the indicative service life in 24/7 operation.

The graphs below express the estimated lifetime of a given component temperature and assumes continuous operation at this temperature.

Estimated Service Life vs Component Temperature

