

Alpha

FXM HP 650, 1100, 2000 UPS

Technical Guide: 0170022-J0

Effective: 11/2019



TABLE OF CONTENTS

1	SAFETY	1
	Safety Wording	1
	General Warning and Cautions	1
	Electrical Safety	1
	Battery Safety	2
2	INTRODUCTION	3
	Scope of the Manual	3
	Product Overview	3
	About Battery Backup Systems	3
	About the Alpha FXM HP	3
	Peripherals	4
	Alpha Cordex™ HP Digital Controller	4
3	FXM HP - SPECIFICATIONS	5
	FXM HP - AVR Transition	8
4	FEATURES	11
	Front Panel	11
	Feature Description	12
	Dry Contact Description	13
5	INSPECTION	17
	Check for Damage	17
	Packing Materials	17
	Returns for Service	17
6	INSTALLATION	19
	Installation	19
	Tools Required	19
	Mounting the Alpha FXM HP	19
	Rotating the Control Panel	22
	Replacing the Fan	24
	Wiring the External Batteries	25
	Wiring the Alpha FXM HP	27
	UATS and (UGTS) Option	27
7	OPERATING THE ALPHA FXM HP	29
	Switching the Alpha FXM HP On and Off	29
	Switch Off Procedure	29
	Switch On Procedure (LINE mode)	29

Switching the Alpha FXM HP from Line mode to Inverter mode	29
Switching the Alpha FXM HP from Inverter mode to Line mode	30
8 GETTING STARTED	31
Navigating the FXM HP User Interface	31
Logging in to the Controller	31
Controller Menu Map	32
Overview of the LCD Interface	34
Overview of the Web Interface	47
Email Notification	56
Setting up SNMP Communication	59
Configuring IP Address to Receive Notifications	59
9 FXM HP SYSTEMS	61
Guidelines for Setting Up the FXM HP System	61
The System Mode	61
FXM HP System Functions	63
Modules, Inventory and System Functions	63
Battery Charging	63
Battery Temperature Compensation	64
Battery Test	65
Battery Runtime and Health Estimation	66
AC Output	67
Inverter Control	67
Load Shedding Relays	68
External Fan	69
Keep Alive	69
Creating a FXM HP System Manually	71
Quick Reference for Configuring a FXM HP System	71
FXM HP - Default Values	73
Creating a FXM HP System	76
Configure the Battery Parameters	81
Configure the Battery Temperature Sensors	81
Configure the Charging System Function	82
Configure the Elevated Absorption Charging System	83
Configure the Temperature Compensation System Function	83
Running Battery Tests	83
Configure Battery Runtime and Health Estimation	85
Configure AC Shutdown	85
Configure External Fan	86
Configure Keep Alive	87
Configure Soft Shutdown	87
Configure SNMP UPS Management Information Base	87
Configure Relays	87
Configure Power Outage Alarm	89

10 MAINTAINING THE CONTROLLER	91
Ethernet Communications	91
Connecting via the Web	92
Working with Alarms	92
Active Alarms	92
Alarm Cut-off	93
Alarm Activation Delay at Startup	93
Alarm Summary Relays	93
Creating User Alarms	95
Controller Maintenance	96
Resetting the Controller	96
Resetting via the LCD	97
Changing the Time and Date	97
Changing the Default Login Language	98
Changing User Interface Strings	99
Changing the Web Session Language	100
Changing the System Status Bar	101
Changing the Dashboard Values	102
Data Sharing	102
Replacing the Controller Battery	104
Working with Logs	105
Event and Alert Logs	105
Battery Log	106
Power Outage Log	107
Datalogs	107
Performance Logs	111
File Maintenance	111
File Preferences	112
File Maintenance via the LCD	112
Upgrading the Controller Software	114
Exporting Configuration	115
Importing Configuration	116
Exporting Diagnostic Information	118
Exporting Inventory	118
User Account Maintenance	119
Setting Up Users and Permissions	119
Editing User Permissions	119
Enabling New Users	120
Disabling Users	122
Changing the Default Password - LCD	123
Changing the Default Password - Web	124
Remote Configuration Lockout	125
Module Firmware Upgrades	125
Module Firmware Upgrade	125
Uploading a Firmware File	126
Selecting the File to Upgrade	128

Upgrading the Module	129
11 APPENDIX A - TRIGGERS	131
12 WARRANTY AND SERVICE INFORMATION	133
Technical Support	133
Warranty Statement	133
Product Warranty	133
Battery Warranty	133
Warranty Claims	133
Service Information	133
13 CERTIFICATION	135

LIST OF FIGURES

Figure 1: FXM HP 650 11

Figure 2: FXM HP 1100/2000 11

Figure 3: Dry Contact Overview 13

Figure 4: User Input Layout. 14

Figure 5: Contact Layout (De-energized Shown, Factory Default for C6) 14

Figure 6: ATS Layout 15

Figure 7: Packing Materials and Environmental Codes 17

Figure 8: Menu Structure 33

Figure 9: FXM HP Controller Dashboard 34

Figure 10: Maintenance Page 35

Figure 11: System Maintenance Page 35

Figure 12: LCD Menus 36

Figure 13: Controller Status 37

Figure 14: Time and Date 37

Figure 15: Timezone 38

Figure 16: Network Time Server 38

Figure 17: Synchronize Time 39

Figure 18: System Shortcuts 39

Figure 19: Status 40

Figure 20: AC Input 40

Figure 21: AC Output 40

Figure 22: Battery 41

Figure 23: Battery Test 41

Figure 24: Inverter Control 42

Figure 25: AC Shutdown 42

Figure 26: Counters 43

Figure 27: Keep Alive Status 43

Figure 28: External Fan 43

Figure 29: User Inputs Status 44

Figure 30: User Inputs Configuration 44

Figure 31: User Alarms 45

Figure 32: Relays 45

Figure 33: Relays Status 45

Figure 34: Relays Configuration 46

Figure 35: Load Shedding Relays 46

Figure 36: Events Logs. 47

Figure 37:	Dashboard Overview on Web Interface48
Figure 38:	Main Dashboard Tables49
Figure 39:	Table Icons50
Figure 40:	Web Interface Table Features51
Figure 41:	Controller Menu.51
Figure 42:	System Wizards52
Figure 43:	Controller with No System Configured53
Figure 44:	Systems Data Tiles53
Figure 45:	System Menu53
Figure 46:	Modules Menu55
Figure 47:	Alarms Menu55
Figure 48:	Logs Menu56
Figure 49:	Default Ports: SMTP Client and Server.56
Figure 50:	Default Ports: SNMP Manager and Agent59
Figure 51:	SNMP Destination Page:60
Figure 52:	Destination 1 More Information Page:60
Figure 53:	System Mode62
Figure 54:	Three-Stage Charging Cycle64
Figure 55:	Temperature Compensation Voltage Graph65
Figure 56:	Quick Reference for Configuring a FXM System72
Figure 57:	Events and Alerts Log	105
Figure 58:	Battery Log on the LCD.	106
Figure 59:	Battery Log on the Web.	107
Figure 60:	Battery Log in Excel	107
Figure 61:	Datalogs Table	107
Figure 62:	Datalog Window: Status, Signals, Configuration and Preview Chart.	108
Figure 63:	CPU Memory in Use Performance Log.	111
Figure 64:	Module Upgrade Page - web	126
Figure 65:	Module Upgrade - LCD	126
Figure 66:	Firmware Files Table	127
Figure 67:	Upload File Dialog	127
Figure 68:	Ready to Start Upgrade.	128
Figure 69:	Upgrade in Progress	129
Figure 70:	Upgrade Succeeded	130

LIST OF TABLES

Table 1:	Specifications: FXM HP 650, 1100, 2000.	5
Table 2:	AVR Transition: FXM HP 2000 - 120V	8
Table 3:	AVR Transition: FXM HP 650, 1100 - 120V	9
Table 4:	AVR Transition: FXM HP 650, 1100, 2000 - 230V	9
Table 5:	Feature Description.	12
Table 6:	C1 to C5 Dry Contacts	13
Table 7:	C7 to C8 Optically Isolated User Inputs	14
Table 8:	FXM HP Part Numbers	19
Table 9:	Email Notification Features	57
Table 10:	Email Configuration.	58
Table 11:	FXM HP Operating Mode.	62
Table 12:	Inverter Control Configuration Table	68
Table 13:	The Load Shedding Relays Configuration Table	68
Table 14:	External Fan Configuration Table.	69
Table 15:	Keep Alive Configuration Table.	70
Table 16:	FXM HP - Default Values	73

1 Safety

SAVE THESE INSTRUCTIONS: This manual contains important safety instructions that must be followed during the installation, servicing, and maintenance of the product. Keep it in a safe place. Review the drawings and illustrations contained in this manual before proceeding. If there are any questions regarding the safe installation or operation of this product, contact Alpha Technologies or the nearest Alpha representative.

1.1 Safety Wording

To reduce the risk of injury or death, and to ensure the continued safe operation of this product, the following labels have been placed throughout this manual. Where these words appear, use extra care and attention.

ATTENTION: *The use of attention indicates specific regulatory/code requirements that may affect the placement of equipment and /or installation procedures.*

NOTE: *Notes provide additional information to help complete a specific task or procedure.*

CAUTION: *Cautions indicate safety information intended to PREVENT DAMAGE to material or equipment.*

WARNING: *Warnings present safety information to PREVENT INJURY OR DEATH to personnel.*

NOTE: *HOT! The use of Hot presents safety information to PREVENT BURNS to the technician or user.*

1.2 General Warning and Cautions

WARNING: *You must read and understand the following warnings before installing the system and its components. Failure to do so could result in personal injury or death.*

- Read and follow all instructions included in this manual.
- Only trained personnel are qualified to install or replace this equipment and its components.
- Use proper lifting techniques whenever handling equipment, parts, or batteries.

1.3 Electrical Safety

WARNING: *Hazardous voltages are present at the input of power systems. The DC output from some UPS devices and batteries can have high voltage and high short-circuit current capacity that may cause severe burns and electrical arcing.*

Before working with any live battery or power system, follow these precautions:

- Remove all metallic jewelry, such as watches, rings, metal rimmed glasses, or necklaces.
- Wear safety glasses with side shields at all times during the installation.
- Use OSHA approved insulated hand tools. Do not rest tools on top of batteries.

WARNING: *Lethal voltages are present within the system. Always assume that an electrical connection or conductor is energized. Check the circuit with a voltmeter with respect to the grounded portion of the enclosure (both AC and DC) before performing any installation or removal procedure.*

- Do not work alone under hazardous conditions.

- A licensed electrician is required to install permanently wired equipment. Input voltages can range up to 240Vac. Ensure that the utility power is disconnected and locked out before performing any installation or removal procedure.
- Ensure that no liquids or wet clothes come into contact with internal components.
- Hazardous electrically live parts inside this unit are energized from the batteries even when the AC input power is disconnected.
- Always assume electrical connections or conductors are live. Turn off all circuit breakers and double-check with a voltmeter before performing installation or maintenance.
- Place a warning label on the utility panel to warn emergency personnel that a reserve battery source is present which will power the loads in a power outage condition or if the AC disconnect breaker is turned off.
- At high ambient temperature conditions, the internal temperature can be hot so use caution when touching the equipment.

1.4 Battery Safety

- Never transport an enclosure with batteries installed. Batteries must ONLY be installed after the enclosure has been securely set in place at its permanent installation location. Transporting the unit with batteries installed may cause a short circuit, fire, explosion, and/or damage to the battery pack, enclosure and installed equipment.
- Servicing and connection of batteries must be performed by, or under the direct supervision of, personnel knowledgeable of batteries and the required safety precautions.
- Batteries contain or emit chemicals known to cause cancer and birth defects or other reproductive harm. Battery post terminals and related accessories contain lead and lead compounds. Wash your hands after handling batteries.

WARNING: Follow battery manufacturer's safety recommendations when working around battery systems. Do not smoke or introduce an open flame when batteries (especially vented batteries) are charging. When charging, batteries vent hydrogen gas, which can explode.

- Batteries are hazardous to the environment and should be disposed at a recycling facility. Consult the battery manufacturer for recommended local authorized recyclers.

2 Introduction

2.1 Scope of the Manual

This manual covers the features, options, installation and startup of the Alpha FXM HP family of UPS (uninterruptible power supply) devices. Images contained in this document are for illustrative purposes only and may not exactly match your installation. This manual supports the following Alpha FXM HP models:

- FXM HP 650-24Vdc – with a 24Vdc battery string voltage (120Vac and 230Vac)
- FXM HP 650-48Vdc – with a 48Vdc battery string voltage (120Vac)
- FXM HP 1100-48Vdc – with a 48Vdc battery string voltage (120Vac and 230Vac)
- FXM HP 2000-48Vdc – with a 48Vdc battery string voltage (120Vac and 230Vac)

2.2 Product Overview

2.2.1 About Battery Backup Systems

Battery Backup Systems (BBS) / Uninterruptible Power Supply (UPS) are the first line of defense to keep critical loads backed up during power outages as well as increasing equipment reliability by protecting them against power disturbances. Battery Backup Systems need to be rugged, reliable, and informative in the data they provide. Typical applications include traffic infrastructure, ITS equipment, security devices, parking gates, ticket dispensers, VMS signs and AC Small Cell power backup. Some of the benefits of BBS are:

- Providing continual power to your operating system in the event of a power outage, sag or brown out, until regular utility power is restored.
- Conditioning and regulating the quality of the commercial power supply to your critical load.
- Keeping your traffic intersections and data flowing to prevent or minimize severe accidents and downtime.
- Reducing operating expenses by eliminating false service call-outs and expensive truck roll-outs.

2.2.2 About the Alpha FXM HP

The Alpha FXM HP is a new line of rugged UPS power modules for the most demanding environments where clean backup power is needed. Alpha FXM HP units ensure equipment in critical applications remains safe and protected from power disturbances and outages. Some of the key features of the FXM HP are below:

- Full color LCD touchscreen display
- Front panel LEDs for alarms, progress and status indication
- Dual Ethernet ports for remote or local communication
- USB-A port for upgrades or file management via a standard USB flash drive
- USB-Mini B port for soft shutdown using MegaTec protocol compliant client
- Independent CAN bus ports for communication with the Alpha Cordex™ family of products
- User programmable dry contacts for control and monitoring of key functions

- Customizable user configurations that can be exported and imported to other FXM HP units

2.2.3 Peripherals

The FXM HP can be used together with an external analog and digital input and output peripheral to monitor electrical signals (temperature, voltage, current) and generate electrical signals through relays.

The most commonly used ADIO (Analog Digital Input Output) peripheral is the L-ADIO (Low Voltage-Analog Digital Input Output) for low voltage systems. Features include:

- Eight digital inputs
- Four voltage sensors
- Four temperature sensors
- Four current sensors
- 12 Form C relay outputs

2.2.4 Alpha Cordex™ HP Digital Controller

The FXM HP uses the advanced Alpha Cordex™ HP digital controller for monitoring and control. It offers a common user interface across all Alpha products – FXM HP, DC Power Plants, Inverter Systems and Line Powering. This provides seamless integration of multiple systems allowing comprehensive management and common interface using a single IP connection.

***NOTE:** While referring to monitoring and control **FXM HP** or **Controller** will be used interchangeably in this manual.*

3 FXM HP - Specifications

Table 1: Specifications: FXM HP 650, 1100, 2000 (Sheet 1 of 4)

	FXM HP 650-24 120Vac	FXM HP 650-24 230Vac	FXM HP 650-48 120Vac	FXM HP 1100 120Vac	FXM HP 1100 230Vac	FXM HP 2000 120Vac	FXM HP 2000 230Vac
Electrical Input							
Voltage Range in Line Mode (Vac) +/-2V	85-171	153-322	85-171	85-171	153-322	85-150	153-322
Nominal Frequency (Hz)	50Hz or 60Hz (Autodetect Frequency is the default configuration, can also be manually configured.)						
Frequency Tolerance in Line Mode	+/- 5%						
Maximum Input Current (A) ¹	8	4.4	10.5	15	8	20	12
Input Breaker Rating (A)	10	5.5	15	20	10	25	15E
Electrical Output							
Output Voltage Setting (V)	120	210, 220, 230, 240	120	120	210, 220, 230, 240	120	210, 220, 230, 240
% Regulation (Line Mode)	+/-10%						
% Regulation (Inverter Mode)	+/-2%						
Rated Power (W/VA)	650	650	650	1100	1100	2000	2000
Frequency (Hz)	Same as Input Frequency						
Battery							
Battery String Voltage (V)	24	24	48	48	48	48	48

Table 1: Specifications: FXM HP 650, 1100, 2000 (Continued) (Sheet 2 of 4)

	FXM HP 650-24 120Vac	FXM HP 650-24 230Vac	FXM HP 650-48 120Vac	FXM HP 1100 120Vac	FXM HP 1100 230Vac	FXM HP 2000 120Vac	FXM HP 2000 230Vac
Maximum Charging Current (A)	10	10	10	15	15	15	15
Battery Breaker Rating (A)	80	80	50	50	50	80	80
Performance							
Line Mode Efficiency ²	>98%	>98%	>97.5%	>98%	>97%	>97.5%	>97%
Inverter Mode Efficiency ³	>75%	>75%	>85%	>85%	>85%	>85%	>85%
Typical Transfer Time	5ms						
Voltage THD (%)	<3%	<3%	<3%	<3%	<3.5%	<3%	<5%
Waveform	Pure Sine Wave						
Load Crest Factor	3:1 (load dependent)						
Mechanical							
Dimensions H x W x D mm (in)	89 x 432 x 229(3.47 x 17 x 9)			133 x 394 x 222 (5.22 x 15.5 x 8.75)			
Weight without batteries kg (lb)	11.3 (25)			14 (31)		18 (40)	
Mounting	Shelf, rack or wall; horizontal or vertical mount						
Cooling	Forced air (fan cooled) with optional external fan cooling for enclosure						
Display	Full graphic LCD, 480x272 pixels, Resistive touch screen						

Table 1: Specifications: FXM HP 650, 1100, 2000 (Continued) (Sheet 3 of 4)

	FXM HP 650-24 120Vac	FXM HP 650-24 230Vac	FXM HP 650-48 120Vac	FXM HP 1100 120Vac	FXM HP 1100 230Vac	FXM HP 2000 120Vac	FXM HP 2000 230Vac
Communication Ports	2 x RJ45: Ethernet 1 x USB A 1 x USB Mini B 1 x RJ12: CAN 1 x RJ11: Battery Temperature Compensation						
Indicators	Solid Green: Line Mode Flashing Green: Inverter mode Yellow: Minor alarms Red: Major/Critical alarms						
Environmental							
Full Load Operating Temp Range ⁴	-40 to 55°C @60Hz -40 to 50°C @50Hz	-40 to 40°C @210V -40 to 50°C @220V -40 to 55°C @230, 240V	-40 to 55°C	-40 to 50°C	-40 to 55°C @220, 230, 240V -40 to 45°C @210V	-40 to 50°C	-40 to 55°C
Humidity	Up to 95% (non condensing)						
Altitude, m (ft) ⁵	3700 (12,000)						
Audible Noise ⁶	45dBa @ 1 meter						
BTU/Hr (Inverter Mode)	700	845	375	640	675	1235	1185
Connections							
AC input and output connectors	Terminal block, Weco p/n 324-HDS/03 or equivalent (max 10 AWG)						
Dry contacts	C1 to C5 Programmable NO/NC (240Vac, 1A max) C6: 24VDC @ 500mA, 3 user inputs, ATS: 24VDC/10mA C6: 48VDC @ 500mA, 3 user inputs, ATS: 48VDC/10mA						

Table 1: Specifications: FXM HP 650, 1100, 2000 (Continued) (Sheet 4 of 4)

	FXM HP 650-24 120Vac	FXM HP 650-24 230Vac	FXM HP 650-48 120Vac	FXM HP 1100 120Vac	FXM HP 1100 230Vac	FXM HP 2000 120Vac	FXM HP 2000 230Vac
Compliance							
Safety	UL 1778, CAN/CSA-C22.2 No. 107.3-14, EN 62040-1						
EMC	FCC CFR47 Part 15, Class A, CSPR22, EN62040-2, EN55022 Level A, C62.41						

1. Measured at nominal input voltage and load.
2. Measured at nominal AC Input and full load.
3. Measured at nominal DC Input and full load.
4. Derates 1.4% per °C past this range until a maximum of 74°C.
5. Derates 2°C per 300m (1000ft) above 1400m (4500ft).
6. Measured at 25°C ambient temperature.

3.1 FXM HP - AVR Transition

Table 2: AVR Transition: FXM HP 2000 - 120V

AVR Transition	FXM HP 2000-120 120V (Vac)
Inverter to Boost 2	89.4
Boost 2 to Boost 1	99.5
Boost 1 to Line	112.7
Line to Buck 1	129.6
Buck 1 to Inverter	148.4
Inverter to Buck 1	141.5
Buck 1 to Line	126.4
Line to Boost 1	110.4
Boost 1 to Boost 2	96
Boost 2 to Inverter	84.8
Vin (Vac) all thresholds are within +/-0.5V of the specified values	

Table 3: AVR Transition: FXM HP 650, 1100 - 120V

AVR Transition	FXM HP 650-24 120V (Vac)	FXM HP 650-48 120V (Vac)	FXM HP 1100 120V (Vac)
Inverter to Boost 2	89.1	89	89.4
Boost 2 to Boost 1	99.5	99.5	99.9
Boost 1 to Line	113.2	113.2	113.6
Line to Buck 1	129.6	129.6	129.6
Buck 1 to Buck 2	149.3	149	148.4
Buck 2 to Inverter	170.8	170.7	170.9
Inverter to Buck 2	162.9	162.8	163
Buck 2 to Buck 1	145.5	145.4	145.6
Buck 1 to Line	127.1	126.9	126.4
Line to Boost 1	110.4	110.4	110.4
Boost 1 to Boost 2	96.1	96	96.4
Boost 2 to Inverter	84.5	84.4	84.8

Table 4: AVR Transition: FXM HP 650, 1100, 2000 - 230V (Sheet 1 of 2)

AVR Transition	FXM HP 650-24 230V (Vac)	FXM HP 1100-48 230V (Vac)	FXM HP 2000-48 230V (Vac)
Inverter to Boost 2	161.9	162	161.4
Boost 2 to Boost 1	183	182.7	182.4
Boost 1 to Line	212.1	211.8	211.8
Line to Buck 1	248.4	248.4	248.4
Buck 1 to Buck 2	280.8	280.6	280.1
Buck 2 to Inverter	321.7	322	322.4
Inverter to Buck 2	306.8	307.1	307.5

Table 4: AVR Transition: FXM HP 650, 1100, 2000 - 230V (Continued) (Sheet 2 of 2)

AVR Transition	FXM HP 650-24 230V (Vac)	FXM HP 1100-48 230V (Vac)	FXM HP 2000-48 230V (Vac)
Buck 2 to Buck 1	274	274.3	274.6
Buck 1 to Line	239.2	239	238.6
Line to Boost 1	207.3	207	206.9
Boost 1 to Boost 2	174.5	174.4	173.9
Boost 2 to Inverter	153.6	153.6	153.1

4 Features

4.1 Front Panel

The figures below shows the front panel connectors and circuit breakers.

Figure 1: FXM HP 650

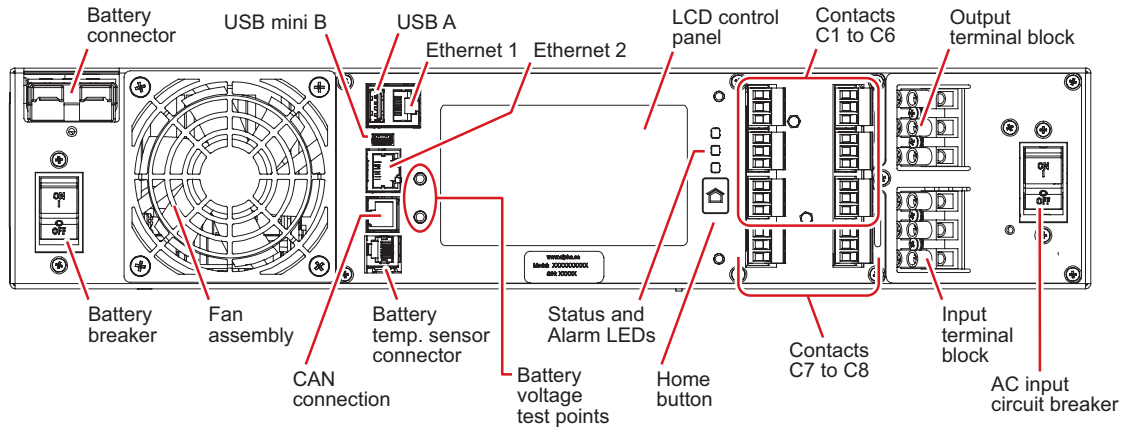
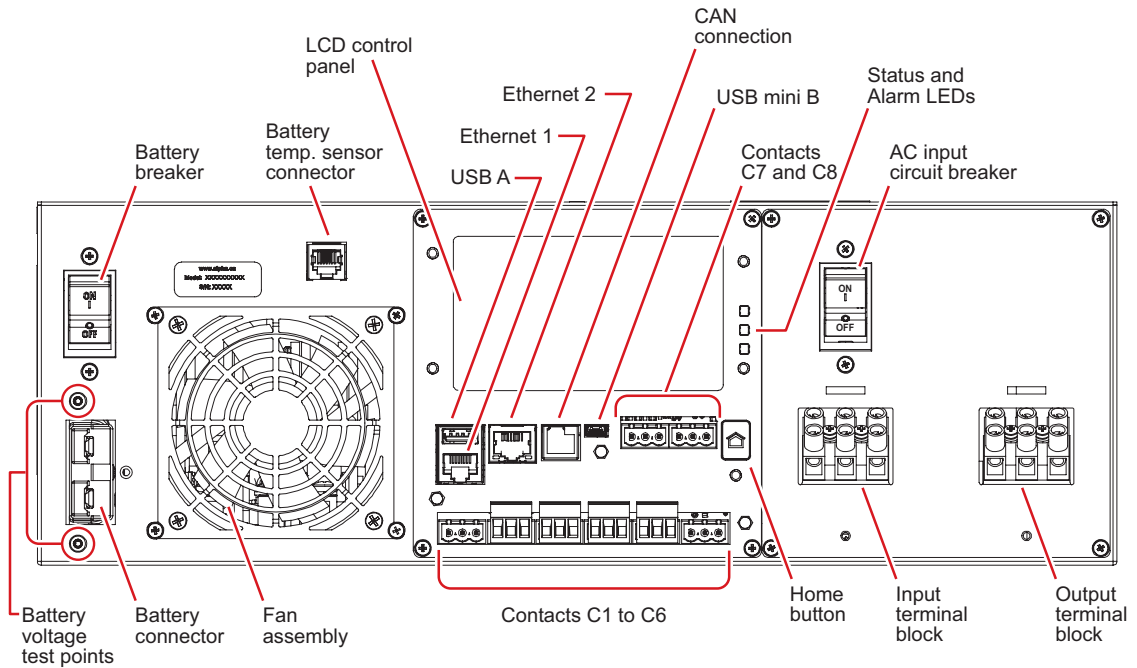


Figure 2: FXM HP 1100/2000



4.2 Feature Description

Table 5: Feature Description (Sheet 1 of 2)

Feature	Description
AC Input Circuit Breaker	This circuit breaker is an On/Off switch for the utility/line power into the unit. It must be switched On for proper operation.
Battery breaker	This circuit breaker provides over-current protection and is used as an On/Off switch for the battery power. It must be switched On for proper operation.
Battery connector	The battery connector connects the external batteries to the unit.
Battery temperature sensor connector	The battery charging voltage is temperature dependent when compensation is not set to 0 mV/°C/cell. A battery temperature sensor connects to the unit so the microprocessor can adjust the charging voltage for optimum charging. Refer to UPS Maintenance > Battery . The sensor MUST be attached to the unit for normal operation. If the sensor is not attached, a “Temperature Probe Unplugged” alarm appears on the LCD.
Battery voltage test points	These test points accept 2mm diameter test probe tips. The battery circuit breaker must be on to measure the battery voltage. <i>NOTE: The battery voltage test points are not to be used as a power port.</i>
CAN connection	CAN connector connects additional Input/Output ADIO modules to the system.
Ethernet (1 & 2)	Ethernet ports 1 and 2 connect the unit system to the network. The default IP address for Ethernet Port 1 is 192.168.0.90 and the Ethernet Port 2 is Auto.
Fan assembly	This microprocessor-controlled fan turns on at a preset temperature to lower the unit’s internal temperature. It must not be blocked. An Alarm is generated if the fan fails; a failed fan can be replaced in the field.
Input Terminal Block	The unit’s AC line power input.
LCD control panel	The LCD control panel is used to monitor and control the unit.
LED	Green LED solidly illuminated: the unit is in Line mode and line power is provided to the load. Green LED flashing: the unit is in Inverter mode and backup battery power is provided to the load. Yellow LED solidly illuminated: there is one or more minor active alarm in the unit. Red LED solidly illuminated: there is one or more major or critical active alarm in the unit.

Table 5: Feature Description (Continued) (Sheet 2 of 2)

Feature	Description
Output Terminal Block	The unit's AC power output.
USB-A input	The USB input connector connects USB memory stick for system backup, restore and download of logs and configuration files.

4.3 Dry Contact Description

Contacts C1 to C5 allow the unit to be connected to an external monitoring panel or to traffic control equipment.

Figure 3: Dry Contact Overview

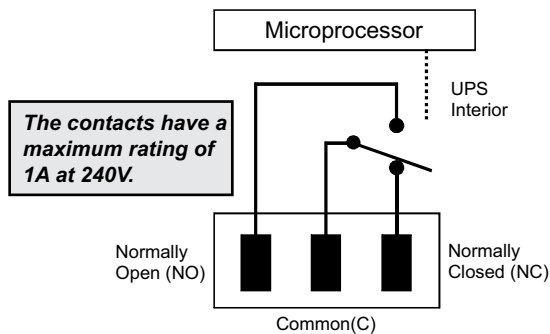
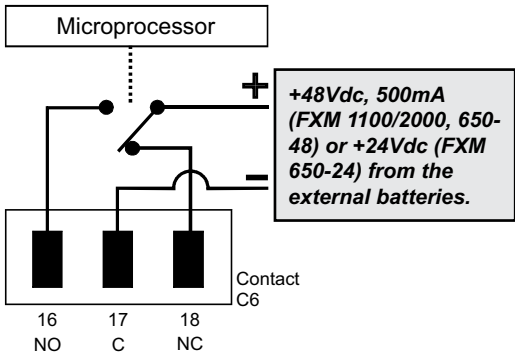


Table 6: C1 to C5 Dry Contacts (Sheet 1 of 2)

Feature	Description
C1 (On Battery)	The C1 contact is energized when line power is unqualified and the unit provides backup battery power to the load(s). It can be used to generate an On Battery contact.
C2, C3 (Low Battery + No Line_LOBAT NOLIN)	These contacts are energized when the battery drops below a pre-set voltage level and line is not present. They can be used to generate a Low Battery alarm. To change the pre-programmed level to match the batteries used and the actual operating conditions, see Low Battery Warning in "UPS Maintenance > Battery".
C4 (Timer)	This contact is energized after the unit has been in Inverter mode for two hours. To change the pre-programmed two hours to match your operating conditions, see <i>Load Shedding Relays</i> .
C5 (Alarm)	The C5 contact is energized when any alarm is generated.

Table 6: C1 to C5 Dry Contacts (Continued) (Sheet 2 of 2)

Feature	Description
C6	<p>The factory default layout for the C6 contact is a relay that is energized when the unit is in Line or Inverter modes and is de-energized when in Standby mode. It provides 48Vdc (500 mA) or 24Vdc (500mA) from the external batteries to an external fan or other equipment. C6 can alternatively be factory-configured as a dry contact.</p> <p>Figure 4: Contact Layout (De-energized Shown, Factory Default for C6)</p> 

Optically isolated user inputs C7 and contacts C8 are used to attach an external switch panel for remote control, or to allow the unit to control optional Alpha Off-Line Automatic Transfer Switch (ATS).

Table 7: C7 to C8 Optically Isolated User Inputs (Sheet 1 of 2)

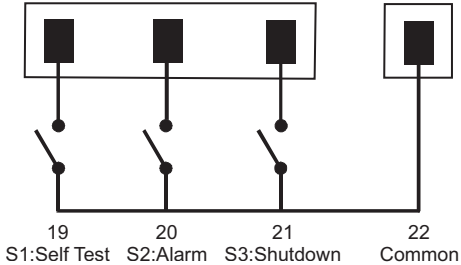
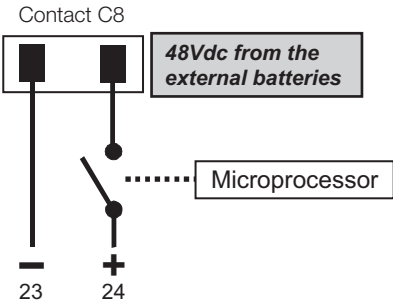
Feature	Description
User Input (C7)	<p>This relay has three contacts that are used to control the unit:</p> <p>19 (S1): Shorting this contact starts the Alpha FXM HP self test.</p> <p>20 (S2): Shorting this contact activates an alarm.</p> <p>21 (S3): Shorting this contact disables the AC output. There is no AC output power, but the unit is still energized if connected to a battery. A manual restart is required to put the unit back to normal operation.</p> <p>22 (C): Isolated return for contacts S1, S2 and S3.</p> <p>Figure 5: User Input Layout</p> 

Table 7: C7 to C8 Optically Isolated User Inputs (Continued) (Sheet 2 of 2)

Feature	Description
ATS (C8)	<p>When the unit is in the Inverter mode, this normally open relay closes sending 48Vdc (FXM HP 650-48, 1100, 2000) or 24Vdc (FXM HP 650-24) from the external batteries to this dry contact. If the optional Alpha Off-Line Automatic Transfer Switch (ATS) is connected, it will cause the ATS to switch the load from line power to battery backup power.</p> <p>Figure 6: ATS Layout</p>  <p>The diagram shows a component labeled 'Contact C8' with two terminals. The left terminal is connected to a ground symbol labeled '23'. The right terminal is connected to a switch mechanism. This switch is controlled by a 'Microprocessor' (indicated by a dashed line) and is connected to a positive terminal labeled '24'. A box labeled '48Vdc from the external batteries' is connected to the switch mechanism, indicating the power source for the contact.</p>

5 Inspection

The inventory included with your shipment is dependent upon the options you have ordered. The options are clearly marked on the shipping container labels and on the bill of materials (BOM).








5.1 Check for Damage

Prior to unpacking the product, note any damage to the shipping container. Unpack the product and inspect the exterior for damage. If any damage is observed contact the carrier immediately. Continue the inspection for any internal damage. In the unlikely event of internal damage, inform the carrier and contact Alpha Technologies for advice on the impact of any damage.

5.2 Packing Materials

Alpha is committed to providing products and services that meet our customers' needs and expectations in a sustainable manner, while complying with all relevant regulatory requirements. As such Alpha strives to follow our quality and environmental objectives from product supply and development through to the packaging for our products. Rectifiers, UPSs, and batteries are shipped on individual pallets and are packaged according to the manufacturer's guidelines. Almost all of Alpha's packaging material is from sustainable resources and or is recyclable. See the following table for the material and its environmental codes.

Figure 7: Packing Materials and Environmental Codes

 PAP/PCB	 PET	 PE-LD	 PS	 FE	 ALU	 NW
Cardboard	Polyethylene Terephthalate	Low Density Polyethylene	Polystyrene	Steel	Aluminum	Wood
Packing boxes Caps	Flexible film Packaging	Bubble wrap Shrink wrap Plastic bags	Foam	Strapping on pallets	Strapping on pallets	Pallets Lumber

5.3 Returns for Service

Save the original shipping container. If the product needs to be returned for service, it should be packaged in its original shipping container. If the original container is unavailable, make sure that the product is packed with at least three inches of shock-absorbing material to prevent shipping damage. Alpha Technologies is not responsible for damage caused by improper packaging of returned products.

If you have any questions before you proceed, call Alpha Technologies: 1 888 462-7487.

6 Installation

6.1 Installation

WARNING: The Alpha FXM HP module **MUST** be correctly grounded for proper operation.

The input and output lines to and from the Alpha FXM HP **MUST** have disconnect devices attached.

This system is designed to be installed in a restricted area accessible by qualified service personnel.

Once the installation location has been planned and prepared, you are ready to install the Alpha FXM HP. There are three steps to setting up the Alpha FXM HP:

1. Mounting the Alpha FXM HP
2. Wiring the external battery
3. Wiring the Alpha FXM HP

6.1.1 Tools Required

Various tools are essential for product installation. Insulated tools are recommended. Use this list as a guide:

- AC/DC voltmeter
- Labels or masking tape and marker
- Torque wrench for input/output terminal blocks
- Slot head screwdriver to fit the terminal blocks
- Minimum #10 AWG copper wire for input/output terminal blocks
- High strength, flame-proof tape
- Battery terminal corrosion inhibitor such as NOCO Company NCP-2 or Sanchem Inc. No-Ox ID Grease "A"

6.2 Mounting the Alpha FXM HP

The Alpha FXM HP can be placed on a shelf with no other parts needed. It can also be rack or wall mounted or secured to a shelf, such as on an outdoor enclosure shelf, with the optional mounting brackets, as shown in the figure below. The brackets and screw kit is available from Alpha Technologies.

Table 8: FXM HP Part Numbers (Sheet 1 of 2)

Product	Part Number
FXM HP650-24, 120V	0170023-002
FXM HP650-24, 230V	0170023-201

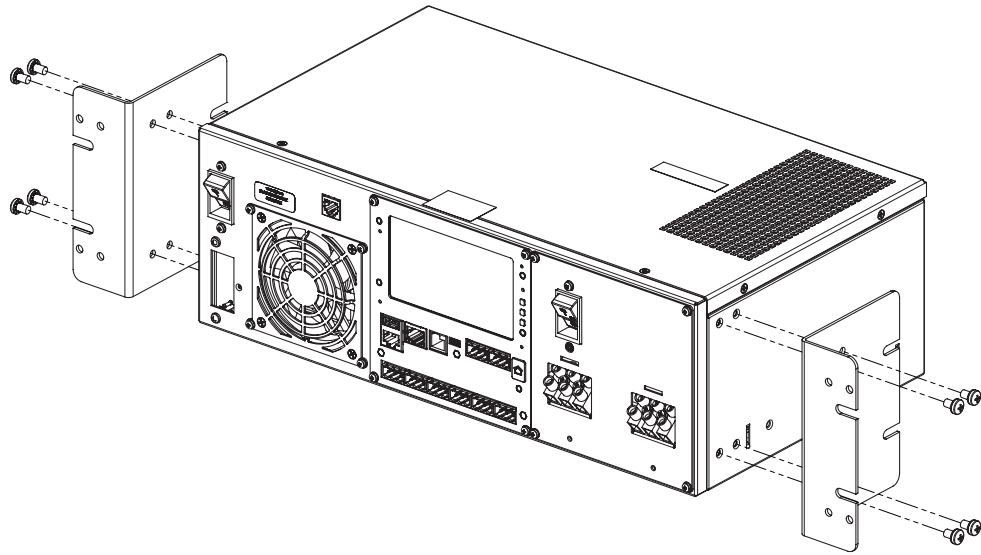
Table 8: FXM HP Part Numbers (Continued) (Sheet 2 of 2)

Product	Part Number
FXM HP650-48, 120V	0170023-101
FXM HP1100, 120V	0170024-001
FXM HP1100, 230V	0170024-101
FXM HP2000, 120V	0170022-001
FXM HP2000, 230V	0170022-101
Rack mount bracket kit	740-697-21 (FXM HP1100, 2000) 740-697-22 (FXM HP650)
Fan replacement kit	0370554-001
Terminal block covers and battery harness restraining bracket	0370555-001

CAUTION: For non-restricted access, terminal block covers and the battery harness restraining bracket must be used and are available from Alpha Technologies. If the Alpha FXM HP end application is mounted inside an enclosure or in an area restricted to authorized personnel, then the covers and bracket may not be needed.

It is advised to do the following when installing the unit in a rack frame:

1. Clean all attachment points on the FXM HP, as well as the rack and mounting brackets and bring them to a bright finish.
2. Coat the attachment points with an anti-oxidant such as Sanchem Inc. No-Ox ID "A-Special Electrical Grade" or equivalent.
3. Attach the mounting brackets with the thread forming screws and the paint piercing washers provided.

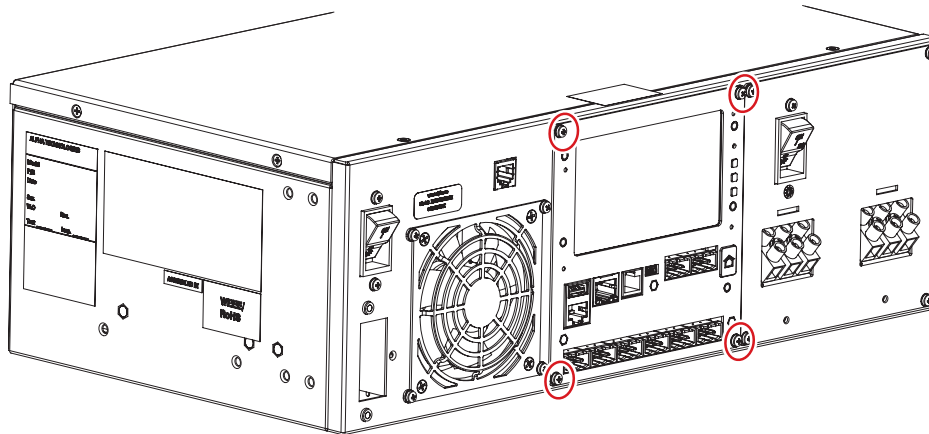


6.2.1 Rotating the Control Panel

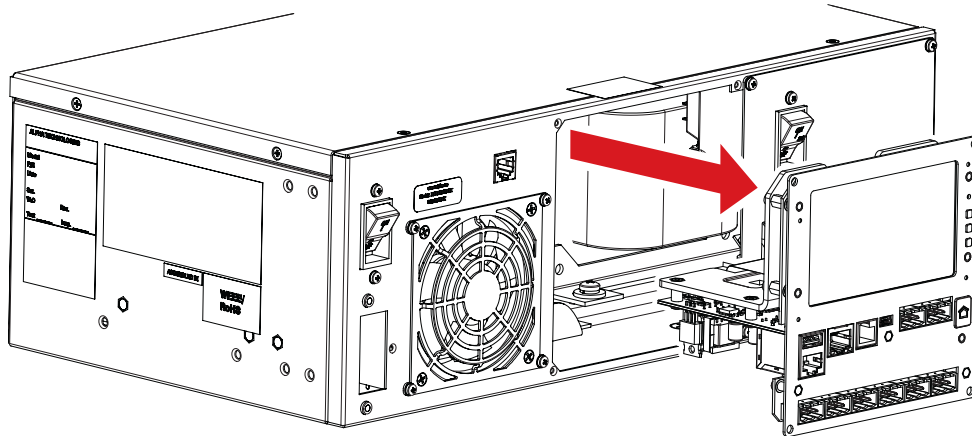
On the FXM HP 1100/2000 units only, the control panel and the power connection panel can be rotated to suit your needs.

To rotate the control panel:

1. Remove the four screws holding the control panel to the FXM HP.

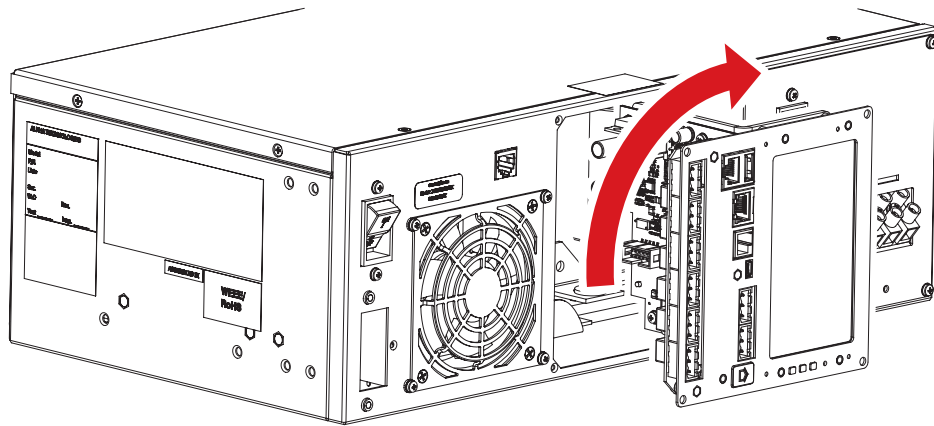


2. Gently pull the control panel sub-assembly out of the unit.

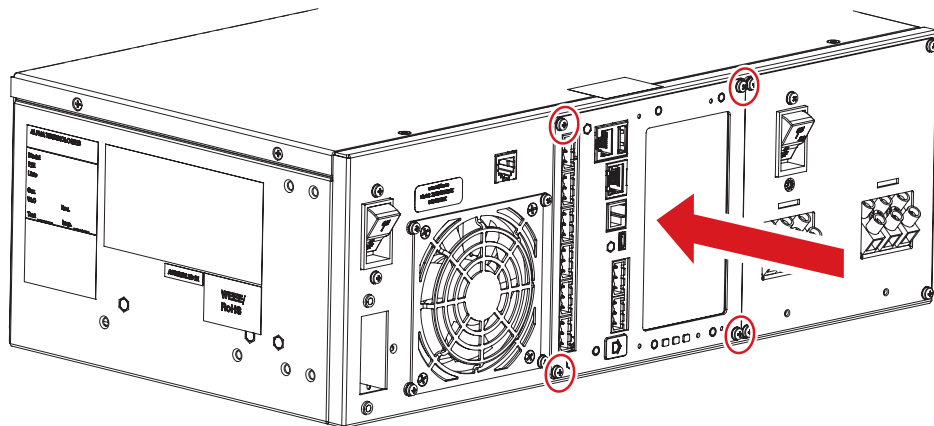


CAUTION: Use care not to stretch the wires or the ribbon cables attached to the back of the unit.

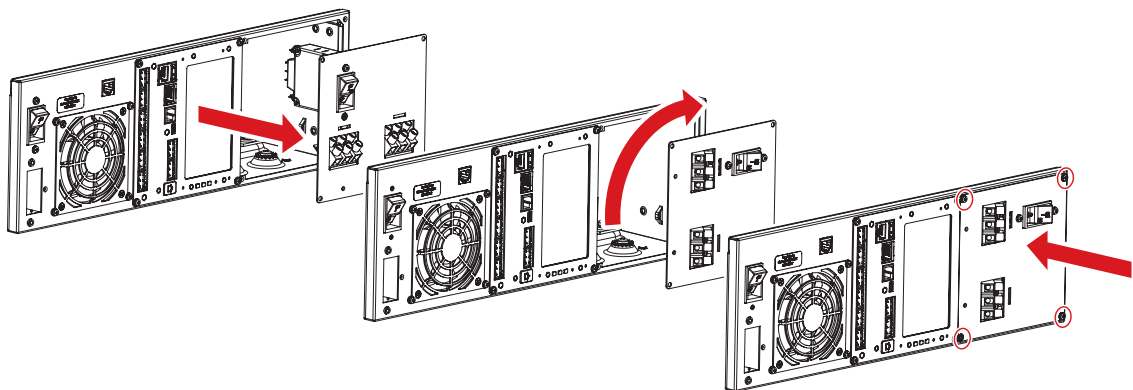
3. Rotate the control panel 90° clockwise. Note that the control panel can only be rotated clockwise 90°.



4. Carefully reinstall the control panel. Smooth out the wires and cables so they do not get caught or pinched. Replace the four screws.



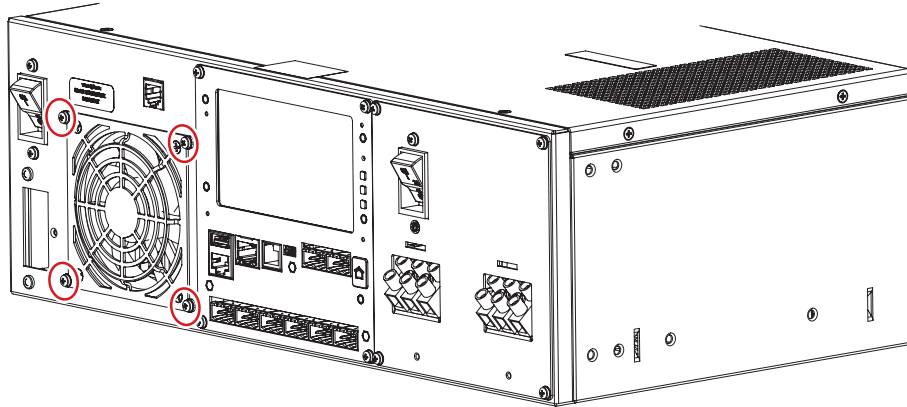
5. Follow the same steps if you want to rotate the TB (terminal block) plate.



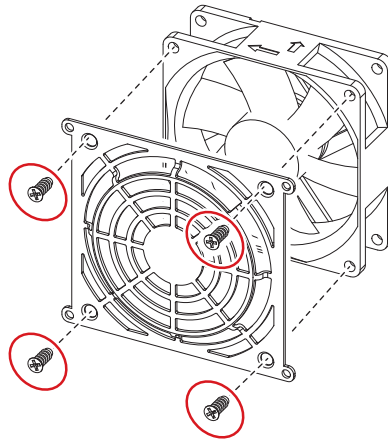
6.2.2 Replacing the Fan

To replace the fan on the FXM HP (1100/2000 shown):

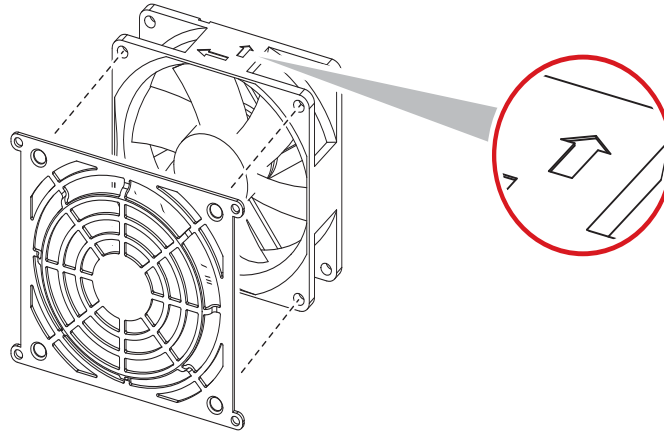
1. Shut down the unit.
2. Remove the four screws connecting the fan plate to the unit.



3. Pull the fan plate assembly out and disconnect the fan connector.
4. Remove the four screws connecting the fan plate to the fan. Discard the old fan.



5. Confirm the air flow direction on the new fan using the air flow indicator. The air flow indicator must point into the FXM HP unit.



6. Reassemble the fan and the fan plate with the four screws removed in Step 4.
7. Plug-in the fan connector.
8. Carefully reinstall the control panel. Smooth out the wires and cables so they do not get caught or pinched.
9. Replace the four screws.

6.3 Wiring the External Batteries

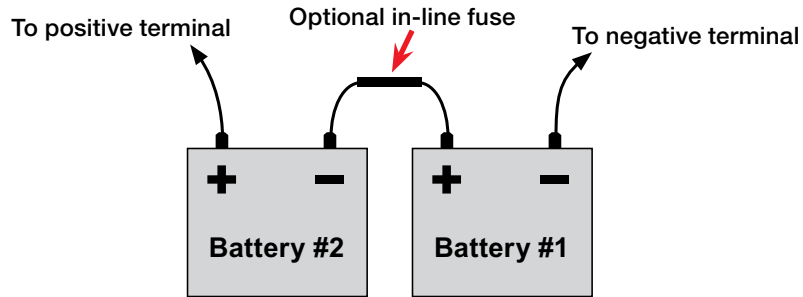
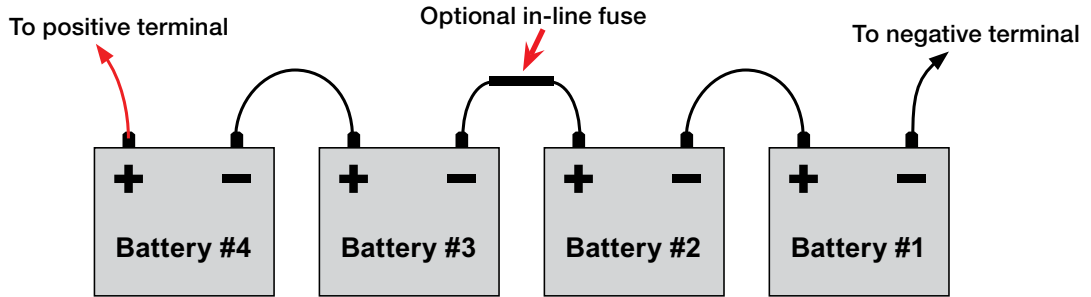
WARNING: The batteries must be installed by qualified personnel trained in the safe use of high-energy power supplies and their batteries. Refer to the safety section in this manual.

- Use new batteries when installing a new unit. Verify that all batteries are the same type with identical date codes.
- For the FXM HP 650-24, the battery string is 24Vdc. For the FXM HP 650-48/1100/2000, the battery string is 48Vdc.
- If you are making your own battery wiring harness, use at least 10 AWG (for FXM HP 650/1100) or 8 AWG (FXM HP 2000) wires.
- The battery return connection is to be treated as an Isolated DC return (DC-I) as defined in GR-1089-CORE.

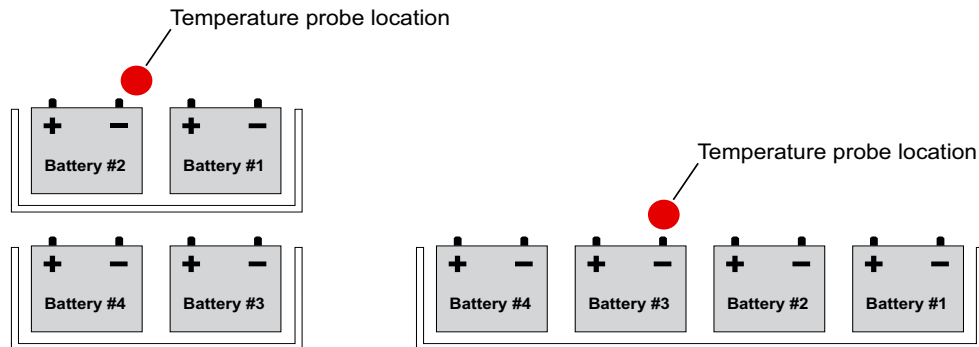
To wire the batteries:

-
1. For FXM HP 650-48/1100/2000 (48 V battery string), number the batteries from 1 to 4 with labels or tape. For FXM HP 650-24 (24 V battery string), number the batteries from 1 to 2 with labels or tape.
 2. Coat the battery terminals with a corrosion inhibitor.

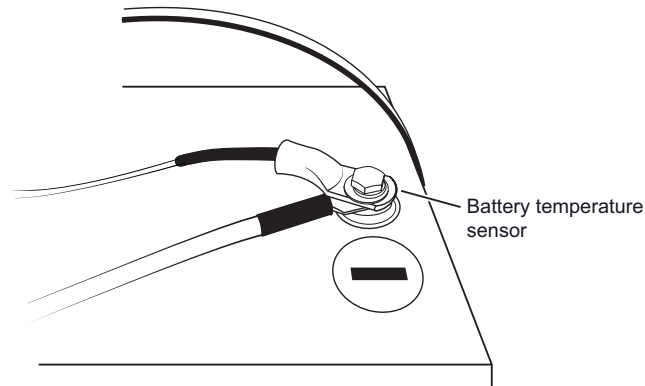
3. Connect the batteries as shown. If used, install the in-line fuse as shown.



4. Connect the black battery cable to the negative terminal of the battery string, and the red battery cable to the positive terminal of the battery string.
5. When the batteries are wired, measure the voltage at the battery connection terminals. It should read between 42 and 54V for the FXM HP 650-48/1100/2000 or 21 and 27V for the FXM HP 650-24. Ensure the correct polarity.
6. Ensure that the DC breaker is OFF.
7. Connect the external batteries to the battery connector on the front panel of the FXM HP.
8. Route the sensor end of the battery temperature sensor to the batteries.
9. Attach the battery temperature sensor to the negative terminal of the battery string. Chose one of the inner batteries as the temperature in this region will be higher due to reduced airflow.



10. Make sure the battery temperature sensor is placed over-top of the battery cable.
NOTE: *Ensure that there is good connection in order to prevent localized heating.*



11. If multiple battery strings are used, repeat steps 1 to 4 as required.
CAUTION: Torque the battery terminals according to the manufacturer's specifications on the battery name plate or data sheet.

6.4 Wiring the Alpha FXM HP

WARNING: *Make sure the line power is off. Switch off all circuit breakers on the Alpha FXM HP before making any electrical connections.*

If stranded wires are used to connect the input and output terminal blocks, ferules or equivalent crimping terminals must be used.

-
1. If used, connect the following ports:
 - Ethernet port
 - Dry contacts C1 to C6
 - User inputs C7 and C8
 2. Connect the load to the Alpha FXM HP **output terminal block**. Torque to 1.4 N-m (12 lb-in).
 3. Connect the line power to the Alpha FXM HP **input terminal block**. Torque to 1.4 N-m (12 lb-in).
 4. If needed, attach the terminal block covers and battery harness restraining bracket.

WARNING: *Before proceeding, verify that the line wire is attached to the terminal block, the ground wire is attached to the ground terminal block, and the neutral wire is attached to the neutral terminal block to prevent accidental shocks or electrocution.*

WARNING: *Ensure AC input and AC output are not swapped at the UPS terminal blocks.*

6.5 UATS and (UGTS) Option

The Universal Automatic Transfer Switch (UATS) and Universal Generator Transfer Switch (UGTS) are the next generation of Automatic Transfer Switch (ATS) and Generator Transfer Switch (GTS) products. They are optional add-on switching units specifically designed for the FXM HP UPS family (FXM HP 650, 1100 and 2000).

These switching units provide power and/or bypass capacity (automatic or manual) so that the operator may safely disconnect the UPS from line or generator power for easy removal and servicing. In bypass mode, the loads are directly connected to the line or generator power without any conditioning.

Depending on the use of one and/or the other, the UATS/UGTS allows the use of up to three different back-up sources (line, batteries and generator). Refer to the UATS/UGTS Installation Manual (Alpha P/N 020-165-B0) for details.

WARNING: *Make sure you have read and understood the instructions given in the UATS/UGTS Installation Manual before making any connection to the supply.*

7 Operating the Alpha FXM HP

7.1 Switching the Alpha FXM HP On and Off

Under normal operation, the Alpha FXM HP is always powered ON to supply uninterruptible power to the load. Switching off the Alpha FXM HP (AC and DC breaker) will disconnect the power supply to the load. If for any reason you need to switch off the Alpha FXM HP while maintaining power to your critical load, make sure that you have a plan that provides an alternate source of power.

7.1.1 Switch Off Procedure

1. Switch the AC circuit breaker **OFF**.
2. Switch the battery circuit breaker **OFF**.

The LCD display goes blank. The Alpha FXM HP is now switched off and no backup power is supplied to the load.

7.1.2 Switch On Procedure (LINE mode)

Before you put the Alpha FXM HP back into commission, make sure that the line is qualified and the batteries are fully charged.

1. Switch the battery circuit breaker **ON**. The LCD displays **STANDBY** in the system mode field.
2. Switch the AC input circuit breaker **ON**. The Alpha FXM HP qualifies the line power. The LCD displays **RETRANSFER** then shows **LINE, BUCK 1, BUCK 2, BOOST 1, BOOST 2** depending on the input voltage.
3. If there is no line power, the Alpha FXM HP remains in **STANDBY** mode until the line power is qualified. To provide backup battery power to the load, run the **Start Up** command on the LCD's System Shortcut Status screen.

The Alpha FXM HP, by default, is configured for auto-frequency detection. When the unit is first switched on, it senses the line frequency and adjusts its output frequency to match that of the input.

If the auto-frequency detection feature is configured, the Alpha FXM HP may not startup in Inverter mode since an output frequency is not yet defined. A **Frequency Unknown** alarm will be activated. To start up the inverter manually when frequency is undefined, run the **Configure FXM System** wizard on the LCD's System Shortcut Status screen to select either 50Hz or 60Hz output frequency.

7.1.3 Switching the Alpha FXM HP from Line mode to Inverter mode

You can force the Alpha FXM HP to operate in the Inverter mode by manually switching off the AC input circuit breaker. Doing so will effectively disconnect any line power to the Alpha FXM HP, simulating a power outage which triggers the Alpha FXM HP to switch to the inverter mode of operation.

To switch the Alpha FXM HP from Line mode to Inverter mode:

1. Switch the AC input circuit breaker **OFF**. The LCD displays **INVERTER** in the operating mode field. The status LED starts flashing green to indicate that the Alpha FXM HP is running on backup battery power. Confirm the load receiving power.

NOTE: Do not leave unit in this mode as it will drain the batteries.

7.1.4 Switching the Alpha FXM HP from Inverter mode to Line mode

The Alpha FXM HP remains in the Inverter mode for as long as the AC input circuit breaker is switched off, or until there is loss of AC power. Backup power is provided to the load until the batteries are drained to a preset level which triggers the Alpha FXM HP to shutdown automatically. If it is not necessary to operate the Alpha FXM HP in the Inverter mode, switch the Alpha FXM HP back to the Line mode as soon as possible.

To switch the Alpha FXM HP from Inverter mode to Line mode:

1. Switch **ON** the AC input circuit breaker. The Alpha FXM qualifies the line power. The LCD displays **RETRAN**, then shows **LINE, BUCK 1, BUCK 2, BOOST 1, BOOST 2**.

If the Alpha FXM constantly switches between Inverter and Line modes because of a noisy line, broaden the input parameter tolerances from **Normal** to **Generator**. See **AC Input > AC Input Sense > Generator**.

8 Getting Started

This section explains how to navigate the menus and do basic connection, monitoring and control functions using the LCD screen, and the web user interface of the FXM HP controller.

8.1 Navigating the FXM HP User Interface

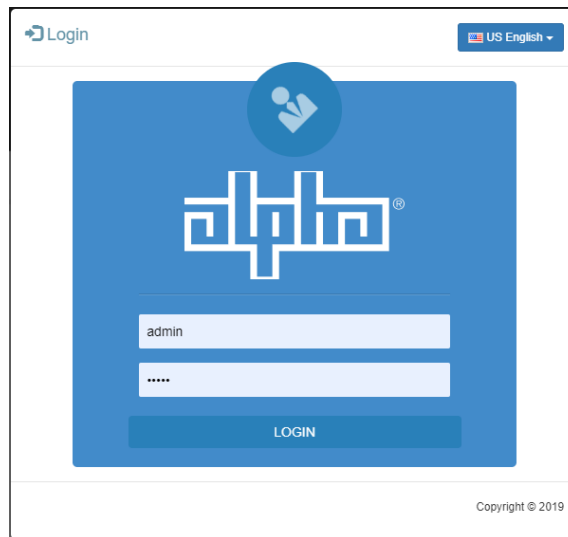
Both the web and the LCD dashboard provide a summary of system, controller and alarm information. When you login to the web interface or the LCD, the dashboard provides an at-a-glance view of the overall system(s).

8.1.1 Logging in to the Controller

You can login to the controller via the LCD or the web interface.

1. Enter the default IP address (192.168.0.90) into the web address bar on the PC.
2. Log in to web interface.

From the **Login** page Enter the User name and Password

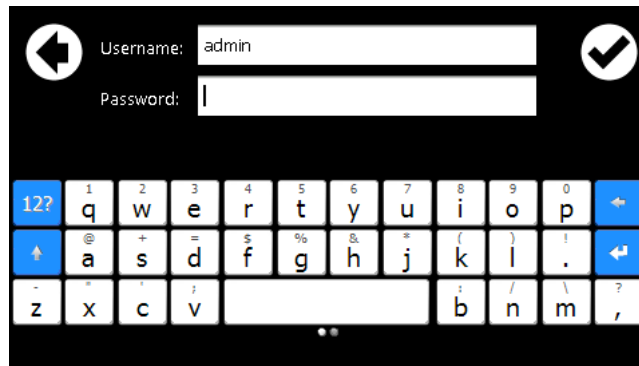


- a. Enter the default User Name: admin (or the user name supplied by your administrator).
- b. Enter the default Password: admin (or the password supplied by your administrator).

NOTE: Once logged in, the session expires after 3 hours, or after 60 minutes with no activity.

Log in to the LCD interface:

3. From the main dashboard of the LCD, press **Login**.

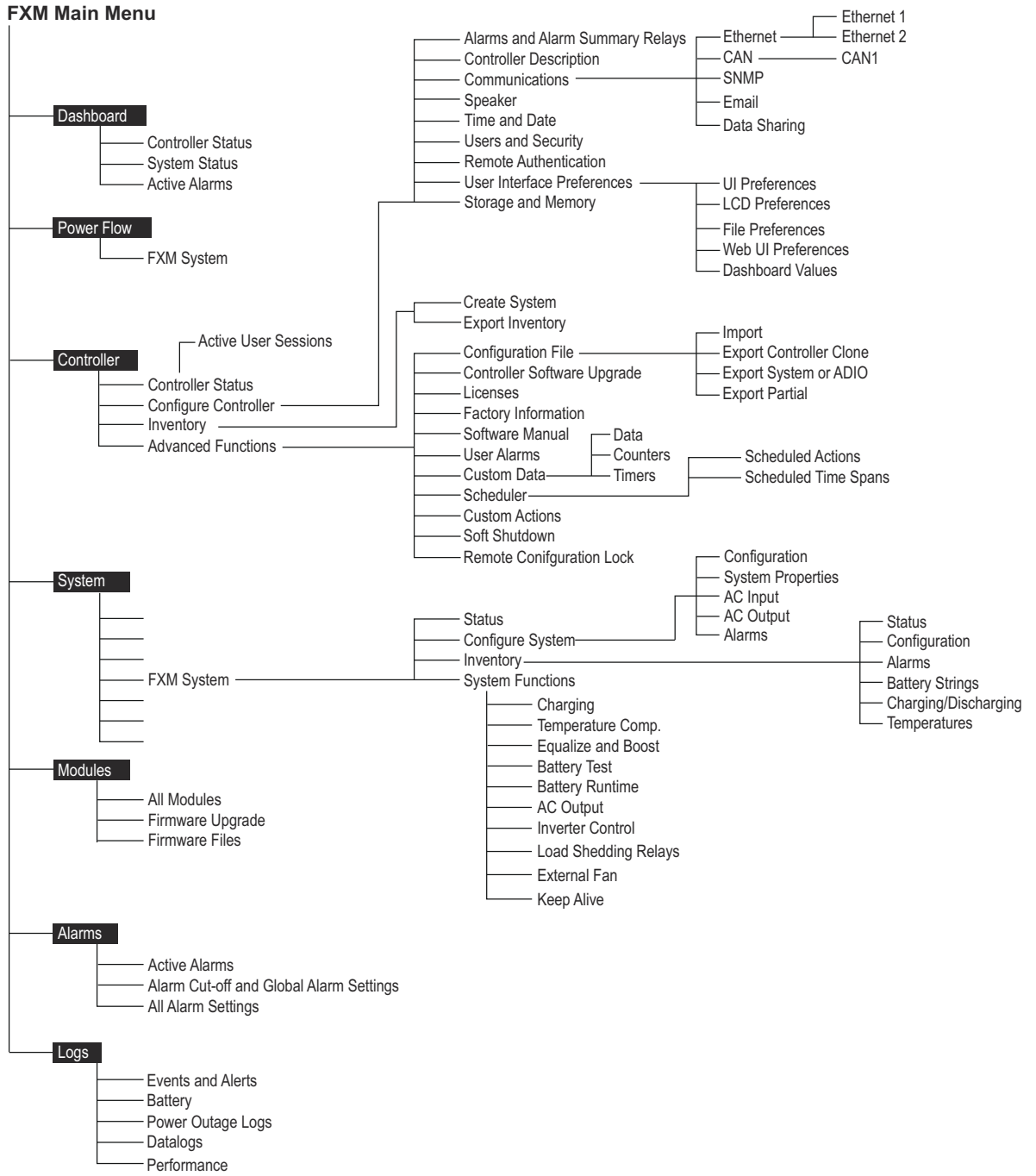


- a. Enter the default User Name: admin.
 - b. Enter the default Password: admin.
4. Press the check mark to complete the login process. The main dashboard displays.

8.1.2 Controller Menu Map

The following is an overview of the menu structure for the controller displaying paths from the main dashboard.

Figure 8: Menu Structure



8.1.3 Overview of the LCD Interface

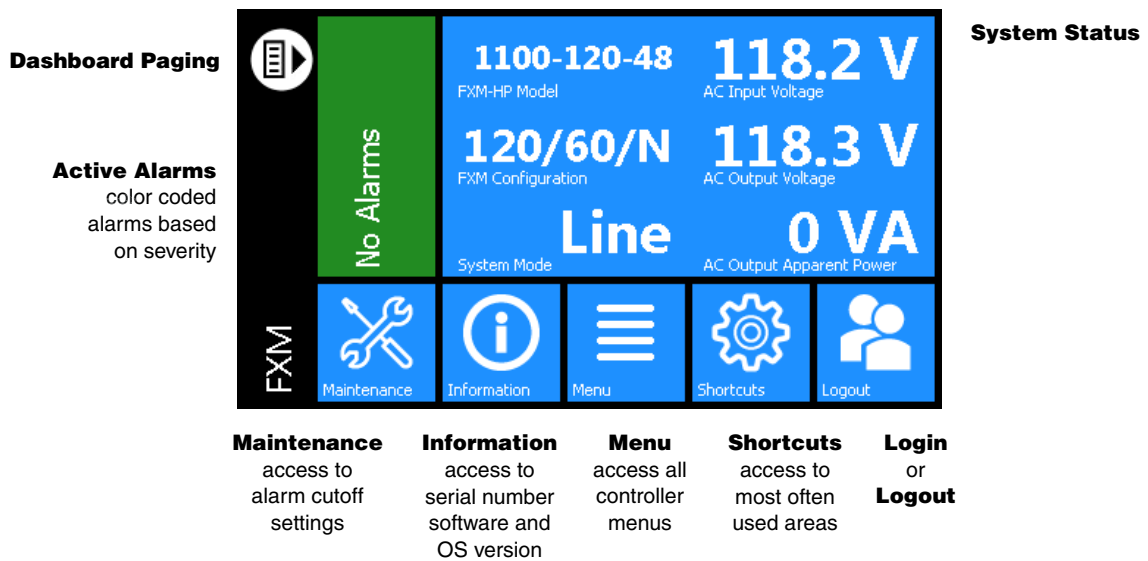
The LCD screen is a touch-sensitive color panel on the front of the controller. The display is always on when the controller is first powered up but after 20 minutes of inactivity the user will be logged out and the display will be turned off. Touching the home button or the LCD in any spot reactivates the LCD screen.

It is possible to change the inactivity time-out of the LCD in the **Controller > Configure Controller > User Interface Preferences** menu. The time-out can be set to 20 minutes, 1 hour, 4 hours, or 8 hours. However, to prevent the LCD screen from wearing out, it is strongly recommended to leave this setting at 20 minutes, unless temporarily changing it for commissioning or demonstrations purposes.

The LCD is most responsive to touch when firm, substantial pressure is applied. A stylus may be used if desired.

The default screen that displays on the controller when it is powered up and running normally is called the dashboard. See the following figure.

Figure 9: FXM HP Controller Dashboard



The upper-left area of the dashboard is the **Alarm** tile. If there are active alarms the LCD will show the top three active alarms.

If there are no alarms in the system, the LCD displays **No Alarms** and the display will be green in color. If there are active alarms the color will match the state of the highest priority alarm as follows:

- Green for okay, no alarms present
- Yellow/orange for minor alarms
- Red for major and critical alarms

Pressing the **Alarm** tile takes you to the **Active Alarms** menu to see a full list of active alarms. From the **Active Alarm** view, you can also activate the alarm cutoff (ALCO) as well as press the individual alarms to get detailed information on each specific alarm.

The upper-right area of the dashboard is the **System Status** tile. This tile displays the key values of a system such as float voltage, battery voltage and system mode. The System Status tile has 24 user configurable fields and can display up to six fields at a time. Pressing the **Dashboard Paging** button on the left can rotate six fields at a time. To configure the dashboard fields, refer to **Changing the Dashboard Values** section.

Pressing the **System Status** tile takes you to the **System Shortcuts** page.

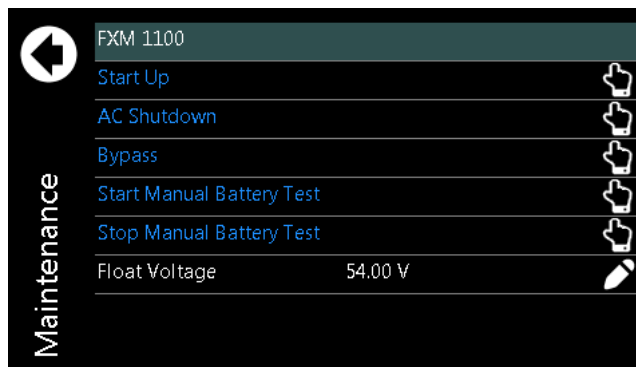
Below the **Alarm** and **System Status** data tiles there are five buttons providing access to the rest of the controller’s functionality. *NOTE: The FXM HP does not have an internal speaker.*

Maintenance: Provides easy access to frequently-needed maintenance tasks including the Alarm Cut-Off. Pressing the Maintenance button takes you to the Maintenance screen. The first page contains general shortcuts, like **Alarm Cut-Off**, **Forget All in Comms Lost** and **Replace ADIO**. Each system defined is also listed on the main page. Pressing a system button provides access to a page of system-related maintenance shortcuts.

Figure 10: Maintenance Page



Figure 11: System Maintenance Page



Information: Provides contact information for technical support, as well as general information about the controller such as the serial number, software version, and Operating System (OS) version.

Menu: Provides access to the controller menu, which follows almost the same menu structure as the web interface.

Shortcuts: Provides quick access to several key functions that are used often, such as the **Ethernet** settings. The **Shortcuts** menu also provides access to functions ONLY supported via the LCD such as:

- USB file browser

- Backup
- Restore
- Display Calibration

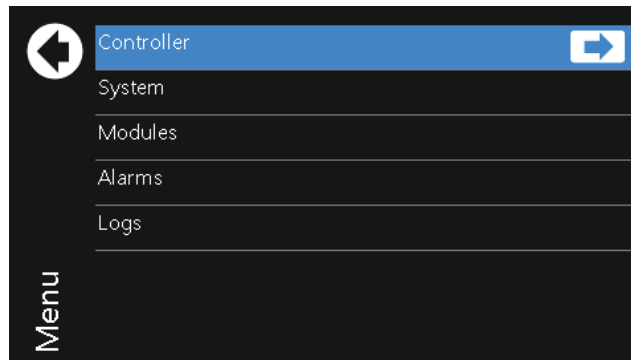
LCD Menu Button

This section provides an overview of all the LCD menus on the controller. The LCD touch screen has a menu structure that mirrors the web interface. Click the **Menu** button on the LCD dashboard to navigate and select menu items. The menu items are as follows:

- Controller
- System
- Modules
- Alarms
- Logs

When a menu item is selected, it is highlighted in blue, and an **arrow** displays on the right side of the screen. Click the arrow to navigate to the next screen.

Figure 12: LCD Menus



For example, press the **Menu > Controller > Controller Status** to view detailed information about the controller.

Figure 13: Controller Status

Reset Controller		Hand icon
Export Diagnostic Information		Hand icon
Serial Number	12344/1118	
Part Number	0123547-00	
Operating System Version	v4.70	
Software Version	v5.20 Dev 1615	
Hardware Version	S1.I1.P1	
Controller ID	CXC4-QU69-AJAX-WQ7R	
CPU Usage	23 %	

When selected, some views display a **pencil** or **hand** icon on the right side of the screen which means you can edit settings or perform actions.

For example, from the **Controller > Controller Status > Configure Controller > Time and Date** screen click the **pencil** icon to set the following:

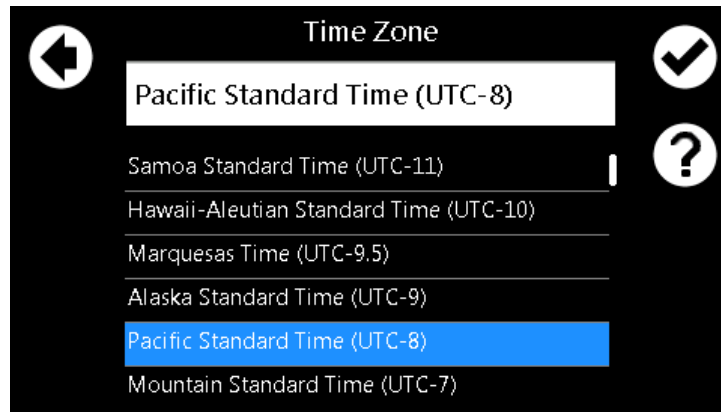
- Current Time and Date
- Time Zone
- Daylight Saving Time Method
- Network Time Server Address

Figure 14: Time and Date

Synchronize Time and Date to Network Time Server		Hand icon
Synchronize Time and Date to Web Browser		Hand icon
Current Time and Date	4/12/2017 11:01:56 AM	Pencil icon
Time Zone	Pacific Time (UTC-8)	Pencil icon
Daylight Saving Time Method	US/Can: 2nd Sunday in March to 1st Sunday in November	Pencil icon
Network Time Server Address	time.nist.gov	Pencil icon

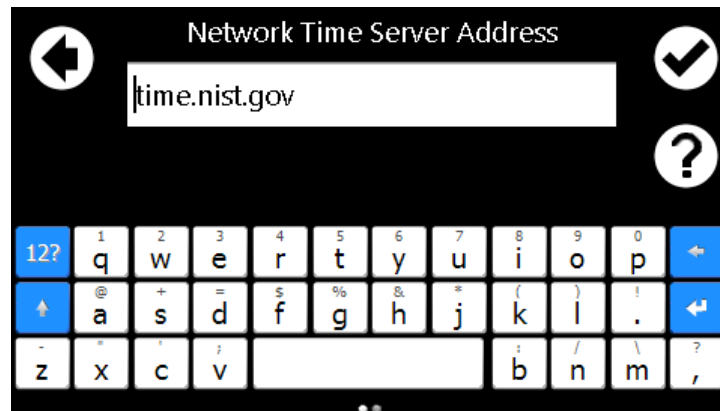
To edit the Timezone, you can choose from the list of supported timezones.

Figure 15: Timezone



If Network Time Server Address is selected, a text field, and on screen keyboard displays.

Figure 16: Network Time Server

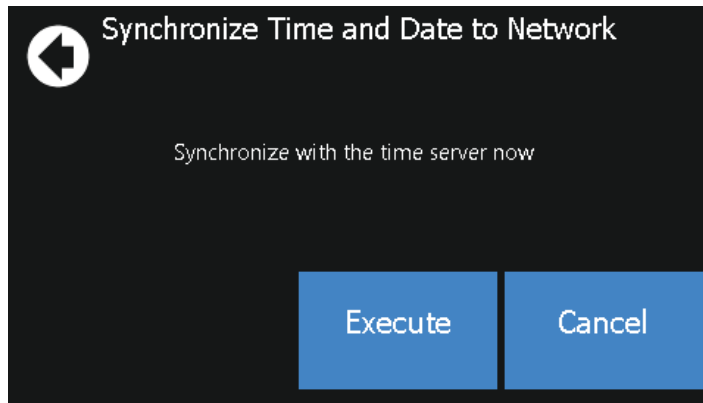


Clicking the **back arrow** cancels an edit, clicking the **check mark** accepts the changes. Clicking the **Help** icon displays a help screen with more information about the item. If the edit is unsuccessful an error displays in red text below the text box. You can either try again, or click the back arrow to abandon the change.

Another screen that displays when clicking items, is the **Execute** screen. For example, **Synchronize Time**. Most edits and executable actions (except ALCO and Restart) require you to login. If you click an editable item or executable action before logging in, the controller responds providing an opportunity to log in and then continue with the action.

When you click the **back arrow** the action is canceled. If you click **Execute**, the command is executed, and the controller provides feedback on whether the action was successful.

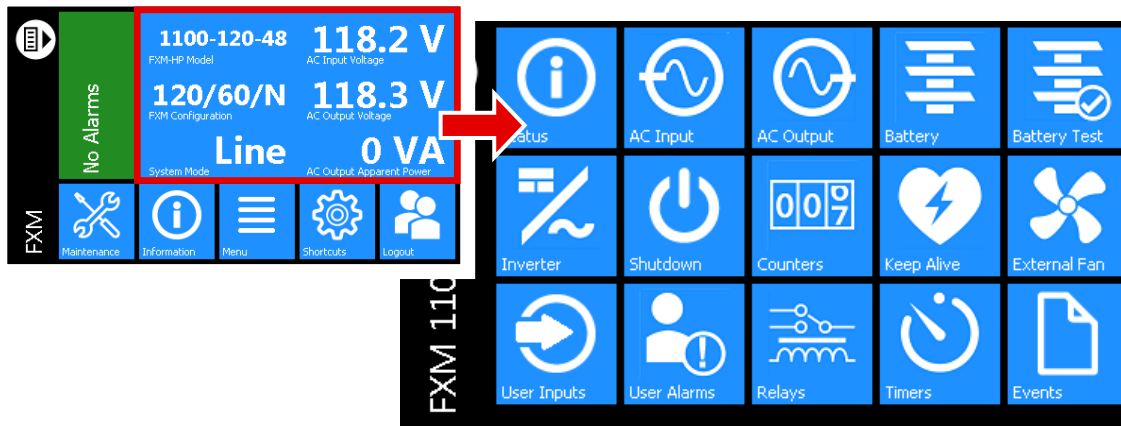
Figure 17: Synchronize Time



FXM HP System Shortcuts

The LCD System Shortcut screen provides quick access to often-used areas of the FXM HP system. To get to the Systems Shortcuts screen, press anywhere on the system area of the dashboard.

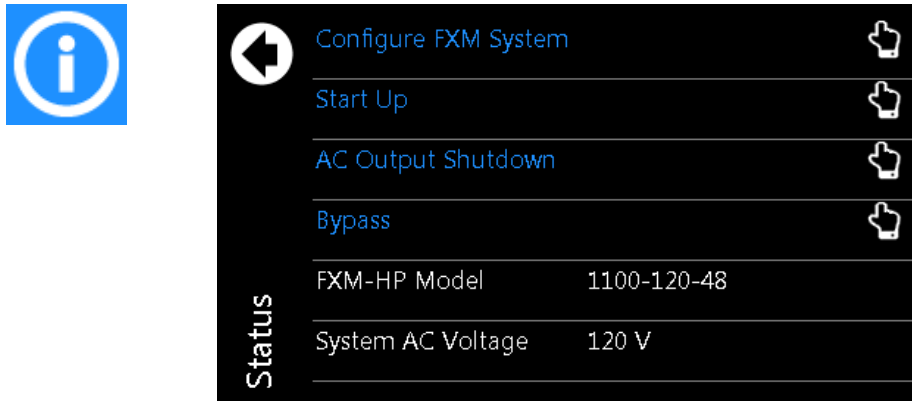
Figure 18: System Shortcuts



System Functions available through the **System Shortcuts** menu are as follows:

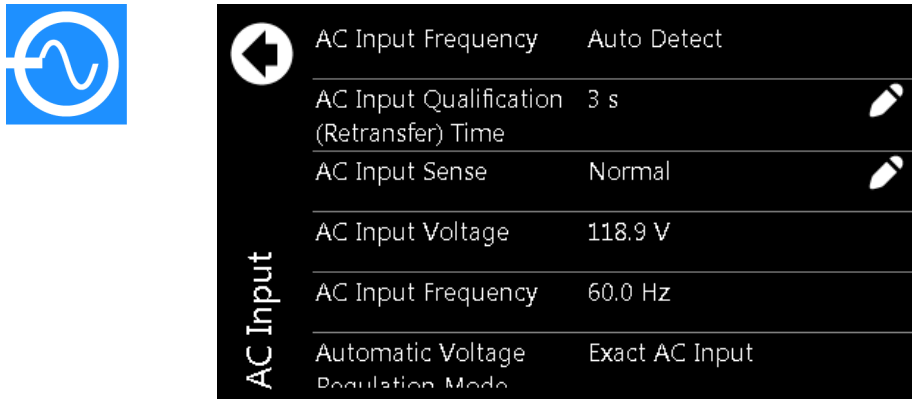
Status: Provides a summary page of the FXM HP system.

Figure 19: Status



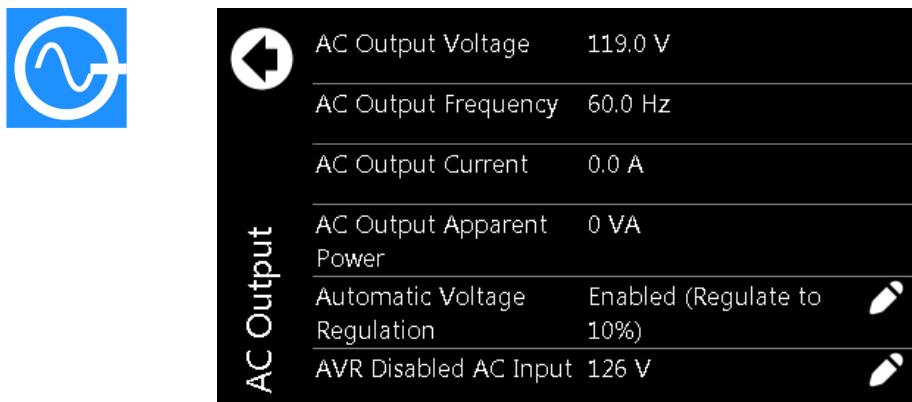
AC Input: Provides a shortcut to **System > Status > AC Input** page.

Figure 20: AC Input



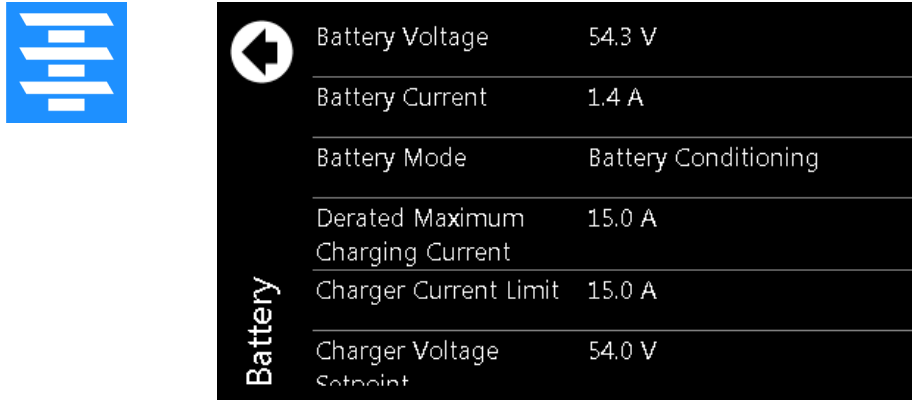
AC Output: Provides a shortcut to **System > Status > AC Output** page.

Figure 21: AC Output



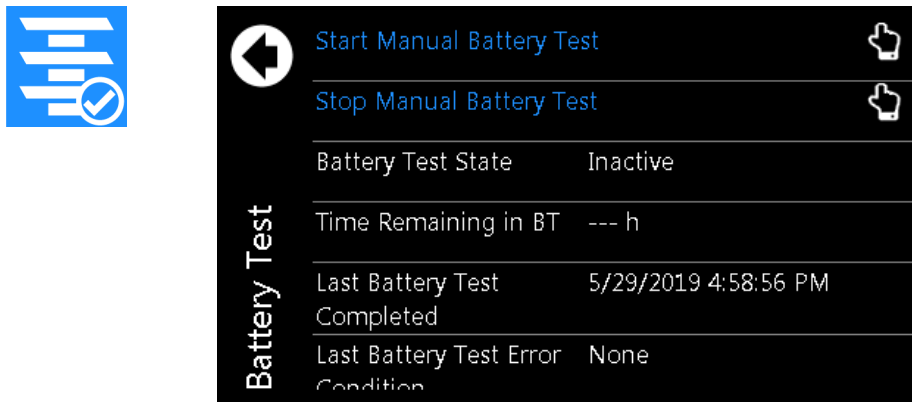
Battery: Provides a shortcut to the **System > Status > Battery** page.

Figure 22: Battery




Battery Test: Provides a shortcut to the **System > System Functions > Battery Test** page.

Figure 23: Battery Test



Inverter: Provides a shortcut to the **System > System Functions > Inverter Control** page to configure the inverter settings. The inverter cannot be turned on/off here.


Figure 24: Inverter Control



Inverter	
Inverter Status	Off
Maximum Time On Inverter Enable	Disabled
Maximum Time On Inverter	301 s
Inverter Shutdown Voltage	42.0 V
Inverter Manual Start Up Voltage	50.0 V

Shutdown: Provides a shortcut to the **System Function > AC Shutdown** page.

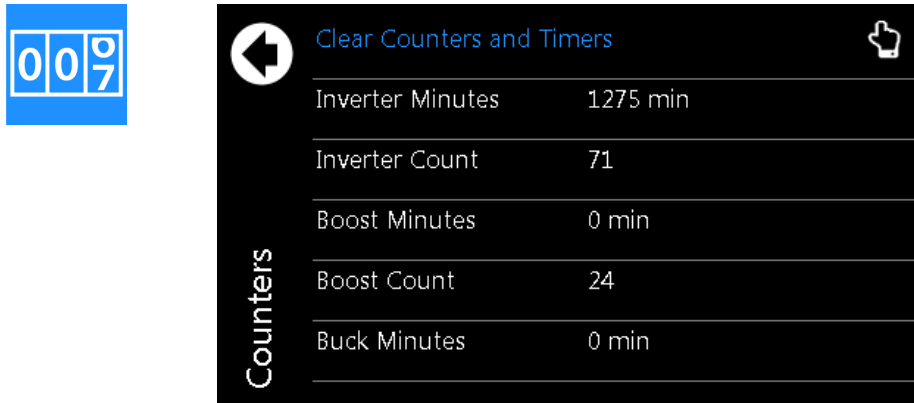
Figure 25: AC Shutdown



AC Shutdown	
AC Output Shutdown Status	Inactive
AC Output Shutdown Trigger State	Inactive
AC Output Shutdown Trigger Source	FXM ADIO: Shutdown
AC Output Shutdown Operation	Auto On After Delay
Auto On Delay	30 s

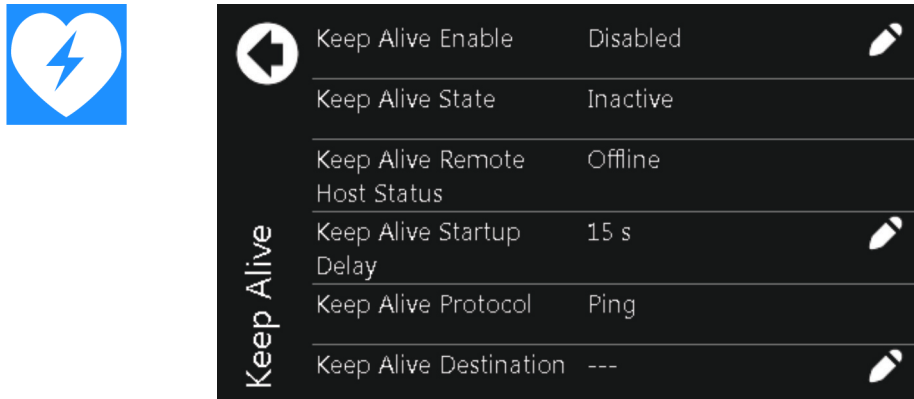
Counters/Statistics: Provides a shortcut to the **System > Status > Statistics** maintenance page to clear Counters and Timers.

Figure 26: Counters



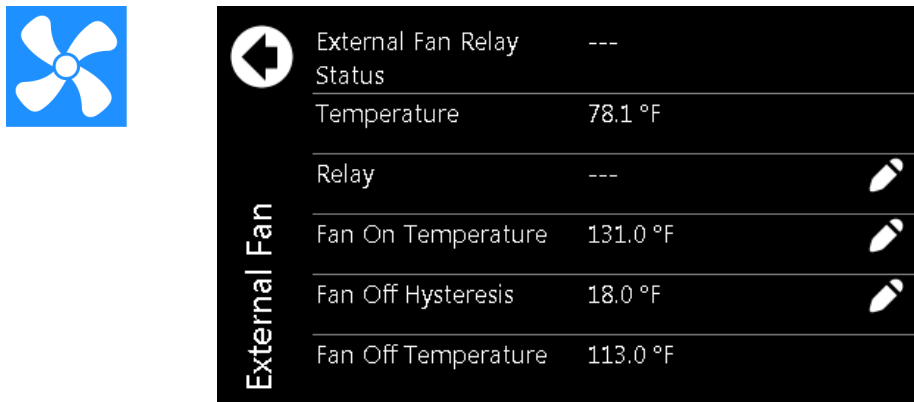
Keep Alive: Provides a shortcut to the **System Functions > Keep Alive** page.

Figure 27: Keep Alive Status



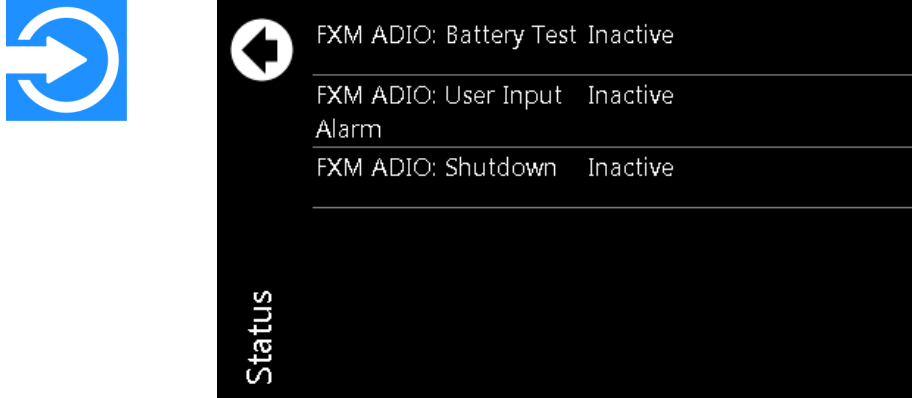
External Fan: Provides a shortcut to the **System Functions > External Fan** page.

Figure 28: External Fan



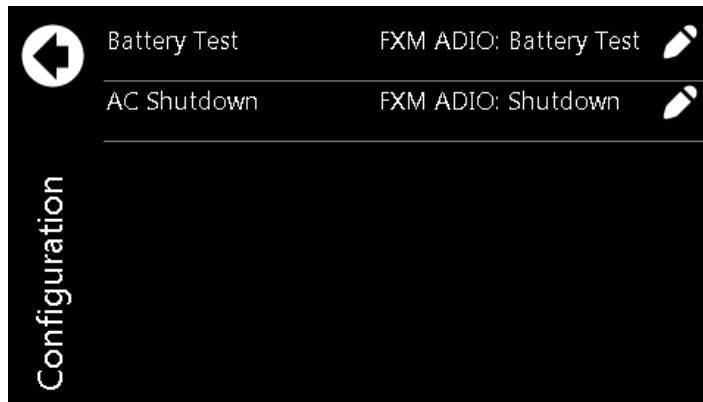
User Inputs: Provides a maintenance page to monitor and configure the user inputs.

Figure 29: User Inputs Status



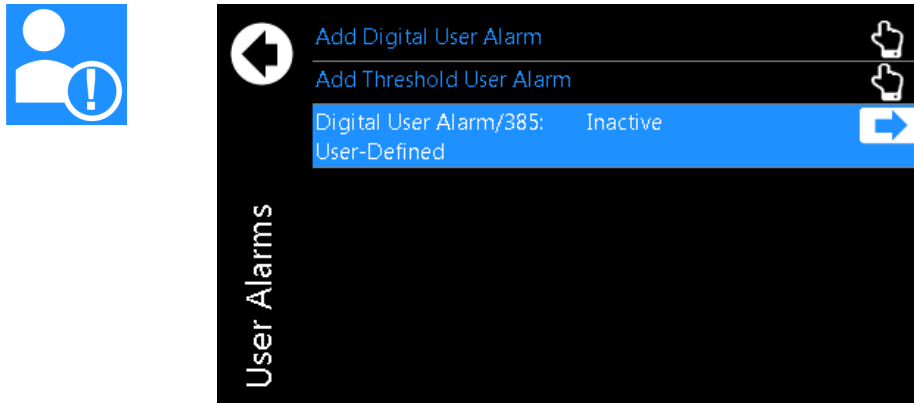
User Inputs: Provides a maintenance page to monitor and configure the user inputs.

Figure 30: User Inputs Configuration



User Alarms: Provides a shortcut to the **Controller > Advanced Functions > User Alarms** page. This page provides the ability to create any user alarms which can be triggered by the status of a user input. See Working with Alarms for more details.

Figure 31: User Alarms



Relays: Provides a maintenance page to monitor and configure the relays.

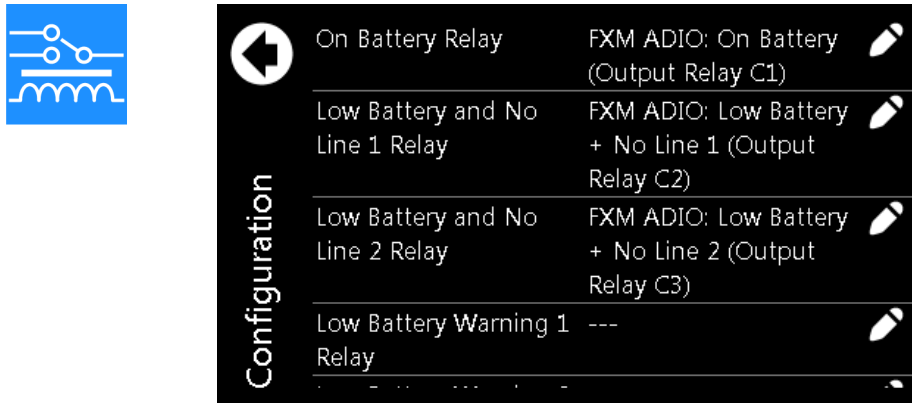
Figure 32: Relays



Figure 33: Relays Status

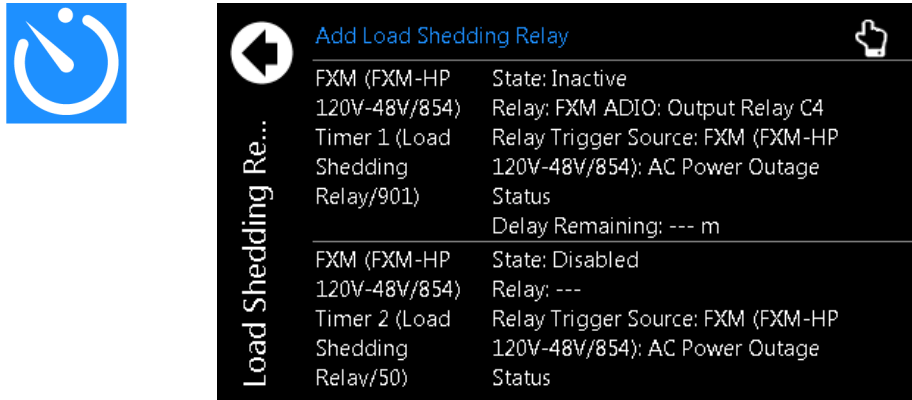


Figure 34: Relays Configuration



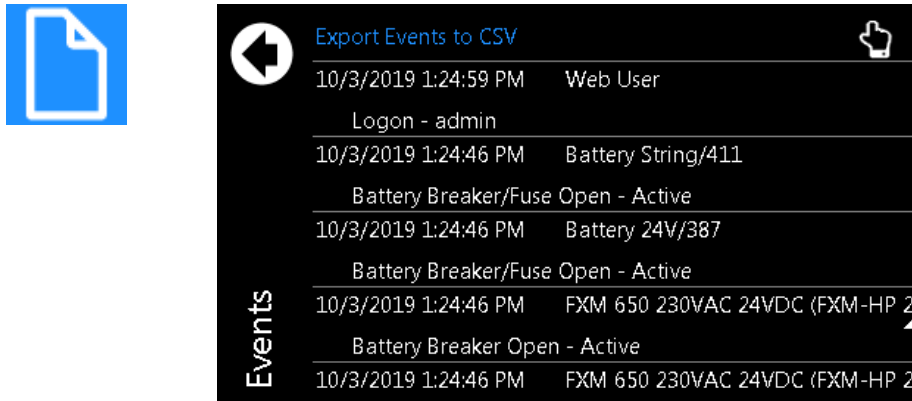
Timers: Provides a maintenance page to configure the load shedding timers. See Load Shedding Relays for more details.

Figure 35: Load Shedding Relays



Event Logs: Provides a record of changes to the state of the system to help with troubleshooting.

Figure 36: Events Logs



8.1.4 Overview of the Web Interface

The dashboard is the default view displayed when you login to the controller via the web. It provides an up-to-date overview of most critical information of your system. It displays controller information, a system summary table, and the list of any active alarms.

The upper-left tile of the screen provides a color-coded live status view of these alarm notifications. The upper-right tile provides a system status bar with detailed information about the system(s).

If there are active alarms, the **Alarm Notification** tile displays the last active alarm according to alarm priority:

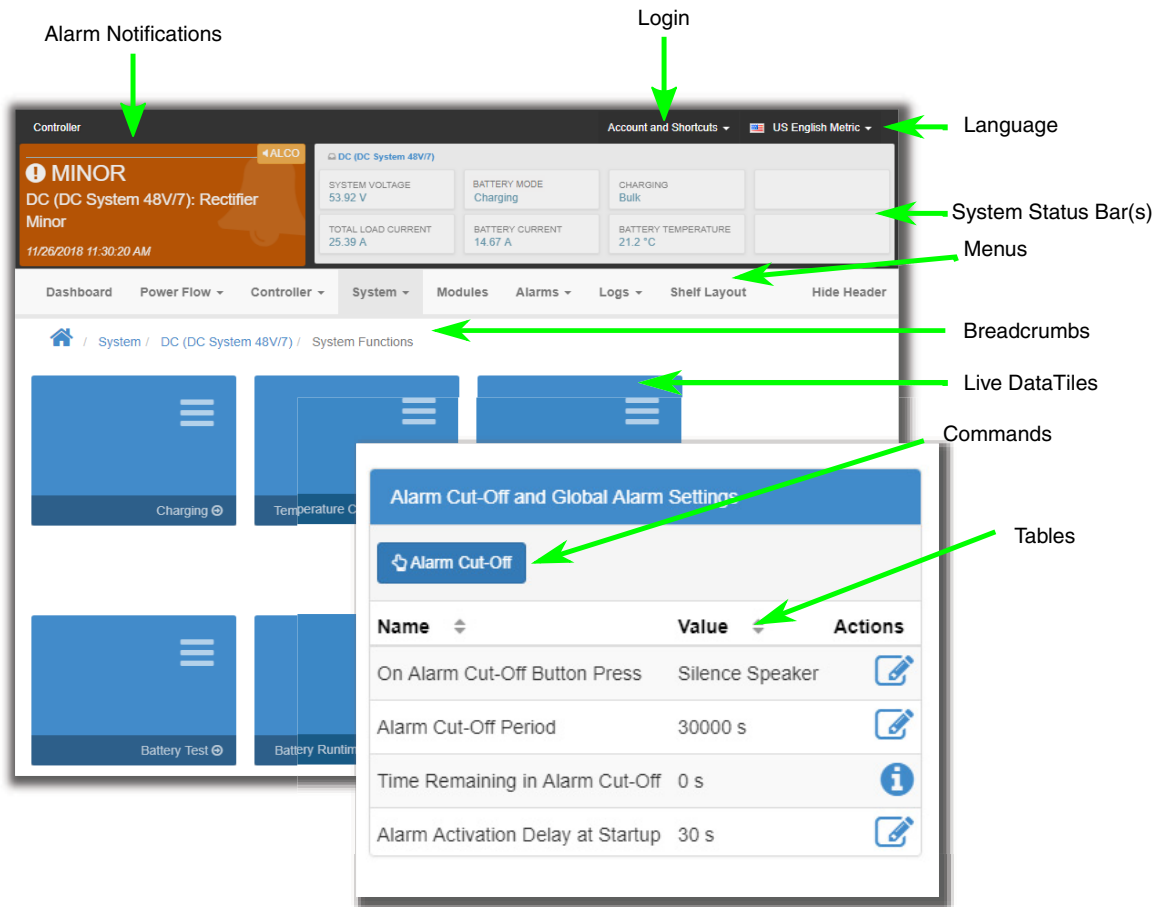
- Red for major or critical alarms
- Amber for minor alarms
- Blue for warnings

Clicking the Alarm tile takes you directly to the **Active Alarms** menu.

The upper-right tile displays **System Status Bar(s)** which contains summary information for the system(s). Clicking the system link at the top of the **System Status Bar(s)** takes you directly to the **System** status screen.

The upper right-side of the of the web interface also provides the **Login** and **Language** drop down menus. From the language drop-down menu you can change the language from English to other languages as well as choose imperial or metric measurement units for the display.

Figure 37: Dashboard Overview on Web Interface



Under the **Alarm Notification** and the **System Status Bar** are the main menus for the controller:

Dashboard (Home), Controller, System, Modules, Alarms and Events, and Shelf Layout.

As you enter the menus, the interface provides a context sensitive breadcrumb trail at all levels so that you can “see” where you are within the system and go back to any previous menu. The lower area of the main dashboard contains system tables with detailed information about:

- Controller Status
- System(s)
- Active Alarms

You can work with the system directly from this area.

Figure 38: Main Dashboard Tables

The dashboard displays four tables with the following data:

Controller Status		
Name	Value	Actions
Operating System Version	v2.20	
Software Version	v4.00 RC 994	
Hardware Version	S1.11.P1	
Controller ID	CXCP-JRQT-BHDP-EHNV	
Memory In Use	8.815 MB	
CPU Usage	17 %	
CPU Delay	35 ms	
Time Since Restart	24.5 h	
Current Time and Date	4/11/2017 11:37:26 AM	

DC System 48V/3038		
Name	Value	Actions
System Voltage	54.00 V	
Total Load Current	--- A	
System Number	---	
Battery Mode	Unknown	
Battery Conditioning	Inactive	
Charging	Inactive	

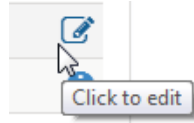
Converter System 48V-24V/8375		
Name	Value	Actions
System Voltage	--- V	
System Number	---	
Total Output Current	--- A	
Voltage Error	--- V	
Converter Current Difference	0 %	
Maximum Allowed Current Difference	5 %	

Active Alarms				
Name	Time of Activation	Priority	Status	Actions
CAN1: Bus State Alarm	4/10/2017 11:10:26 AM	Warning	Active	
CAN2: Bus State Alarm	4/10/2017 11:10:26 AM	Warning	Active	

On each line of the table, the right-side displays an icon. There are three different types of icons.

Figure 39: Table Icons

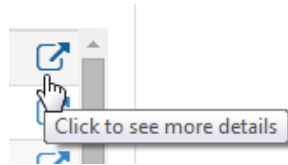
The right-side of every table provides three types of icons.



Edit: provides a details field that allows you to edit values and change parameters.



Help: provides a variety of information which may include a description of the feature, its function and the typical default values.



Click to see more details: takes you into the menus and provides more detailed information on the specific line that was clicked

Paging, Sorting and Filtering - Web

Within the web interface there are three additional features that help you find information: paging, sorting and filtering.

Paging: displays multiple page tabs on tables that have a large quantity of information. If there is too much information for one table the table's lower edge contains a list of numbers which allows you to scroll through the information.

Sorting: provides a way to sort the table columns, either ascending or descending similar to any standard spreadsheet program.

Filtering: provides an easy way to refine the information shown in a particular table.

The search bar on the upper-left side performs a search on each of the space-separated terms in all columns of the table. The "Aa" toggle can be used to make the search case-sensitive, and the "Abc" toggle can be used to only match whole words. For example, typing "dc system major" will display all alarms of priority Major on the DC System.

The following example shows these features on the **All Alarm Settings** table.

Figure 40: Web Interface Table Features

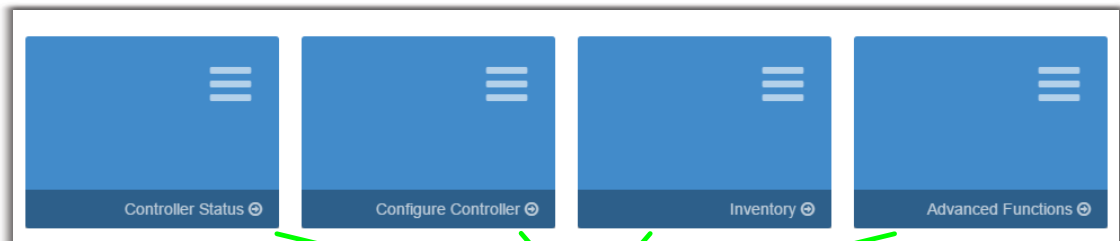
Name	Status	Limit	Priority	Relay	Actions
48V DC System : Output Voltage Very High	Inactive	56.50 V	Major	---	[Link]
48V DC System : Output Voltage Very Low	Inactive	46.50 V	Major	---	[Link]
48V DC System : Invalid System Voltage Reading	Inactive	5.00 V	Major	---	[Link]
48V DC System : Long Term AC Input Fail	Inactive	10.0 min	Major	---	[Link]
48V DC System : Rectifier Fail Count Very High	Active	1	Major	---	[Link]
48V DC System : AC Input Fail	Inactive		Major	---	[Link]
48V DC System : Battery On Discharge	Inactive		Major	---	[Link]
48V DC System : Load 1: Load Breaker/Fuse Open	Inactive		Major	---	[Link]
48V DC System : Battery Disconnect: Disconnect Inhibit	Inactive		Major	---	[Link]
48V DC System : Battery Disconnect: Disconnect Pending	Inactive		Major	---	[Link]

« < 1 2 > » Total Rows Page 14 1/2

Controller Menu - Web

This section provides an overview of the **Controller** menu. The controller area has a total of four sub menus in the form of live data tiles: Controller Status, Configure Controller, Inventory, and Advanced Functions.

Figure 41: Controller Menu



Controller sub menus in the form of live data tiles

Controller Status: Provides the ability to reset the controller and view critical controller related information.

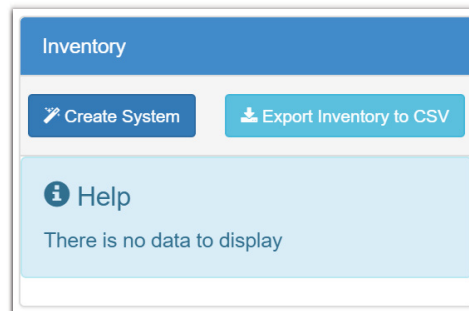
Configure Controller: Provides access to configuration sub-menus including the following:

- Alarms and Alarm Summary Relays
- Controller Description

- Communications
- Speaker (if available)
- Time and Date
- Users and Security
- User Interface Preferences

Inventory: Provides a Inventory table displaying configurable list of systems as well as buttons to manually create or remove them.

Figure 42: System Wizards



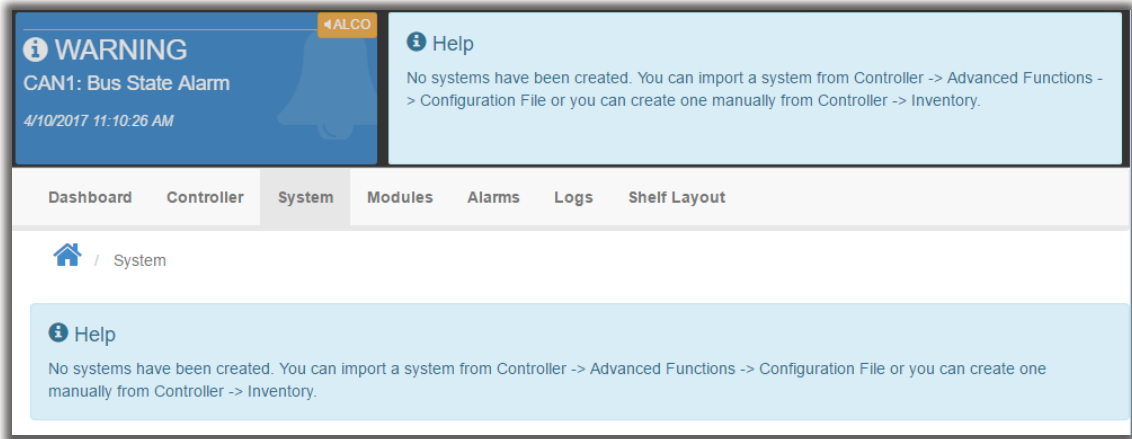
Advanced Functions: Provides sub menus for viewing details and working with advanced functionality, including:

- Configuration File
- Controller Software Upgrade
- Licenses
- Factory Information
- User Alarms
- Custom Data

System Menu - Web

This section provides an overview of the **System** menu. Depending on your system configuration, the power system menu area may have several sub menus in the form of live data tiles (e.g. a DC System and a Converter System). If the controller is new, and a system hasn't been created yet, the web page displays the following information.

Figure 43: Controller with No System Configured



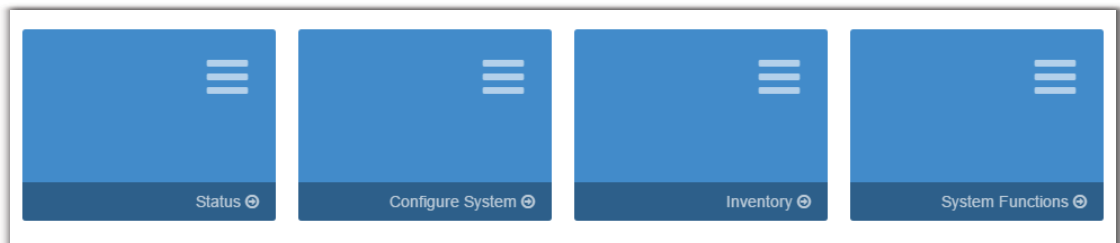
If systems are already configured, they display under the **Systems** menu.

Figure 44: Systems Data Tiles



Most systems will have additional sub menus in the form of live data tiles such as: **Status**, **Configure System**, and **Inventory**. Some systems will also have a **System Functions** sub menu as shown here.

Figure 45: System Menu



Status: Provides a view of the system's general details.

Configure System: Provides system configuration, system properties and system alarms.

Inventory: Provides six sub menus to do add, remove or configure inventory times, e.g.:

- Rectifiers
- FXM HP
- Battery
- Loads
- Disconnects
- Shunts
- Other Transducers

System Functions: Provides sub menus to manage how the system operates, e.g.:

- Charging
- Temperature Compensation
- Equalize and Boost
- Battery Test
- Battery Runtime and Health
- Rectifier Control and Monitoring
- Power Save

Modules Menu - Web

This section provides an overview of the **Modules** menu.

The **Modules** menu has the following tables: **All Modules**, **Firmware Upgrade**, and **Firmware Files**.

Figure 46: Modules Menu

The screenshot displays the 'All Modules' menu with a table of modules and two sub-sections: 'Firmware Upgrade' and 'Firmware Files'.

Identity	Model	Firmware	System	Bus	Node	Comm. Status	Alerts	Actions
L-ADIO/T000053/0813	L-ADIO	9.113	Controller	CAN1	1	Normal	---	Locate, Replace ADIO, [Link]
N409537/1211	CXRF 48V 4KW HP	1.04	DC System 48V/1947	CAN1	10	Normal	0	Locate, [Link]
N578777/0212	CXRC 48V 3.6KW	1.17	DC System 48V/1947	CAN1	11	Normal	0	Locate, [Link]
221005631	CXDF 48V-24V	9.1	Converter System 48V-24V/3902	CAN1	12	Normal	0	Locate, [Link]

Name	Value	Actions
File Info	Select a Firmware (ACAN) File	[Info]
File	---	[Link]
Modules Compatible with File	---	[Info]
Last Upgrade Status	---	[Info]
Last Upgrade File Used	---	[Info]
Last Upgrade Total Modules	---	[Info]
Last Upgrade Remaining Modules	---	[Info]
Last Upgrade Percent Complete	--- %	[Info]

Name	Last Write	Size (bytes)	Actions
0340014-001_D_CXRF_48-4KW_CUSTOMER_V1.02 (1).acan	4/3/2017 12:52:26 PM	34318	[Delete File]
adio_config.txt	3/29/2017 11:30:22 AM	1022	[Delete File]
0340014-001_F_CXRF_48-4KW_CUSTOMER_V1.04.ACAN	4/3/2017 1:02:28 PM	34386	[Delete File]
CXRF 125-4.4kW 1.00b.acan	4/7/2017 1:33:36 PM	49192	[Delete File]
03407602E__FACTORY_CXRF_48-1.8kW_V1.07.acan	4/7/2017 11:53:38 AM	49192	[Delete File]
0350024-001_D_CXRF-HP 48-2KW CUSTOMER_V1.00.acan	4/7/2017 11:58:58 AM	32818	[Delete File]
2017_03_24_16_31_12_TS1_High_Voltage.png	4/7/2017 1:33:46 PM	35447	[Delete File]

All Modules: Provides a table to view or locate all modules.

Firmware Upgrade: Provides a table to start and monitor a firmware upgrade.

Firmware Files: Provides a table to view, upload or delete firmware files.

Alarms Menu - Web

The alarms section has three sub menus: **Active Alarms**, **Alarm Cut-Off and Global Alarm Settings**, and **All Alarm Settings**.

Figure 47: Alarms Menu

The screenshot shows the 'Alarms' menu with a navigation bar and three sub-menu cards.

Navigation Bar: Dashboard, Power Flow, Controller, System, Modules, **Alarms**, Logs, Shelf Layout

Sub-menu Cards:

- Active Alarms
- Alarm Cut-Off and Global Alarm Settings
- All Alarm Settings

Active Alarms: Provides tables to view and configure **Active Alarms** as well as an **Alarm Cut-Off** button.

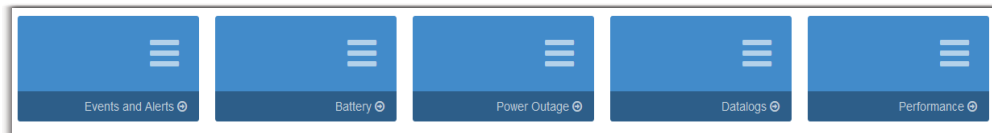
Alarm Cut-Off and Global Alarm Settings: Provides alarm cut-off functionality, configuration and settings for global alarm behavior.

All Alarm Settings: Provides a table to view and configure all possible alarms including relay mapping to alarms.

Logs Menu - Web

The logs section has a total of four sub menus in the form of live data tiles: **Events and Alerts**, **Battery**, **Datalogs**, and **Performance**. Every log can be exported to .csv files for further analysis.

Figure 48: Logs Menu



Events and Alerts: The **Events** table provides a list of system and controller events that record configuration changes, alarms and general controller and system operation. The **Module Alerts** table shows the module alert name and module serial number when a module reports an alert condition.

Battery: The battery log records the duration and change in capacity (Ah) for every charge and discharge of a battery. If you have Battery Runtime and Health enabled, the log will also record the change in State of Charge (SOC) and State of Health (SOH).

Power Outage: The power outage log records the start time, end time and duration of each power outage.

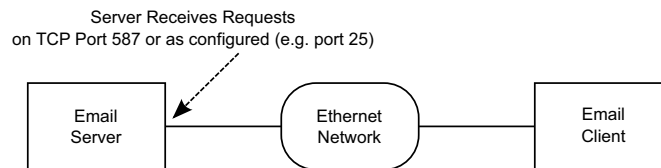
Datalogs: The datalog allows users to record measurements at set intervals over a period of time using the CXC HP sensors and calculated values as inputs.

Performance: The performance log provides daily roll-ups with a minimum, maximum and average value for key usage statistics. For power systems, that usually includes the input voltage and current and the output voltage and current. For the controller, the CPU and memory usage are tracked.

8.2 Email Notification

The CXC HP can be configured to send alarm summary emails. In this case the CXC HP is acting as a Simple Mail Transfer Protocol (SMTP) client. This section of the manual describes the features of and how to set up the CXC HP email client.

Figure 49: Default Ports: SMTP Client and Server



A summary of alarm activities in the controller can be delivered using email. A period of monitoring time is configured, and then all alarms within that period are reported.

This summary is designed to assist decision making when determining the urgency of any action required to resolve issues that may occur in your system.

Table 9: Email Notification Features

Feature	Description
HTML Based Emails	HTML based emails provide better formatting features such as color coding and table alignment.
Multi-level Security	Different security levels are available and automatic detection is executed to support the appropriate level. Direct SSL connection (default port 486) is NOT currently supported.
Encrypted SMTP Server Password	The password used for authentication on the SMTP server is securely encrypted.
Test Email Capability	A test button is available to send a test email ensuring proper configurations are set for email notifications to reach the appropriate monitors.
Public SMTP Server	We currently support the following public server: <ul style="list-style-type: none"> • Gmail – With less secured connection set in the Gmail account. (OAuth2 protocol is not supported. Please refer to Google developer site for more details. https://developers.google.com/identity/protocols/OAuth2)
Private SMTP Server	The controller supports private servers with the following security settings: <ul style="list-style-type: none"> • TLS • Clear text with authentication • Clear text anonymous

Email Content

- Subject line with filterable text and alarm counts.
- Static title for filtering.
- Configurable name of the controller.
- Configurable location of the controller which provides a link to open Google Maps showing the location of the controller (Internet connection required).
- Time and date of the notification.
- List of up to ten active alarms sorted by priority with an active alarm count indicator showing total active alarms.
- List of up to ten cleared alarms sorted by priority with a cleared alarm count indicator showing total cleared alarms.

How Email Notification Works

- An alarm activity is the main item that will trigger an email notification. To avoid overwhelming the network, emails are only sent out at the configured interval set in the **Email Configuration** page.
- When alarm transitions occur (e.g., alarms activating or clearing) a timer starts from the first transition. During this collection period, all alarm transitions are collected for reporting in the email that is sent out at the end of the period. Continued transitions after the email is sent will start another timer for the next email notification.
- Active alarms are reported as a snap shot of all currently active alarms, regardless of when they activated or if they were a part of a previous notification.
- All cleared alarms are collected based on the last occurrence within the collection period. This is to avoid multiple entries of the same alarm in the case the alarm toggled multiple times.

Secured Email

Connection to a SMTP server defaults to TLS secured connection on port 587. Checks are done via the controller and if TLS is not supported, proper degradation of security features is done in the following sequence:

1. TLS handshake attempt.
2. Clear-text authentication with username and password.
3. Anonymous clear-text transmission with no authentication.

The checks are done by following SMTP protocol for SMTP server commands and responses. Please see SMTP protocol standards for more details.

Table 10: Email Configuration (Sheet 1 of 2)

Configuration	Description
Enable	Email notification defaults to inactive. Enabling allows email notifications to go out when all configuration information is set correctly.
SMTP Server Address	A DNS name or an IP address will work in providing a target location of the email server.
Port	Default port is 587
Domain	This is a DNS formatted string (words separated by '.') used for identifying the client to the SMTP server. Required for most public SMTP servers like Google.
SMTP User Name	The username used for authentication to the server to access SMTP resources.
SMTP Password	The password used for authentication to the server to access SMTP resources. Set this value by using the Set SMTP Server Password button. You can clear the configured password by using the Clear Server Password button.

Table 10: Email Configuration (Continued) (Sheet 2 of 2)

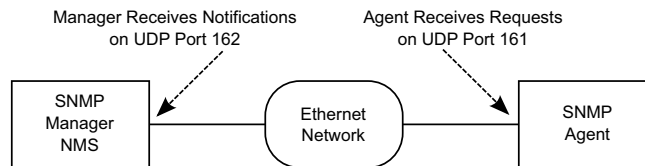
Configuration	Description
From	The From field is used as the source of the email and is usually the same as the Username provided to authenticate the client to the SMTP server. For example, Gmail requires this value to be the email address of the account in use.
To	The To field is for the destination or receiver of the email notification. This field allows multiple email address entries separated by commas.

8.3 Setting up SNMP Communication

Simple Network Management Protocol (SNMP) is a standard protocol or language that Network Management Systems (NMS or SNMP manager) use to control network devices and report information. A typical SNMP system is often represented as one SNMP manager collecting data from several SNMP agents or devices.

The CXC HP acts as an agent or device in an SNMP system. This section of the manual describes how to add a new agent (the CXC HP) to an existing SNMP system. It does not cover how to set up an SNMP manager nor does it explain how to correctly set up an SNMP system. Those topics are specific to the SNMP management software chosen which will have its own documentation.

Figure 50: Default Ports: SNMP Manager and Agent



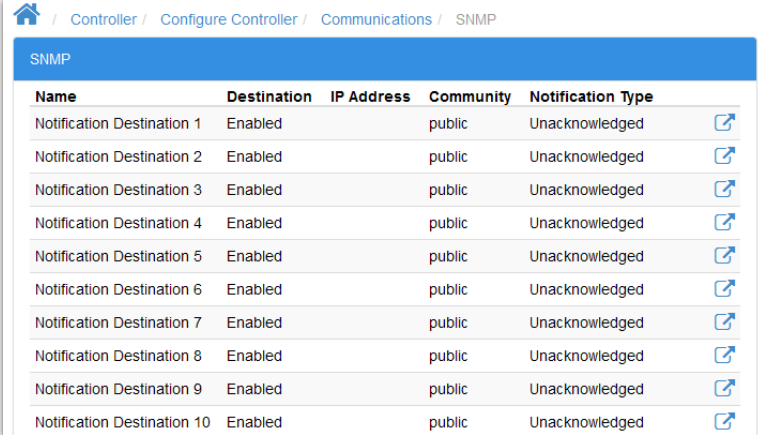
There are two main steps required to add a new agent to your SNMP system:

- Configure the agent with the IP address of your SNMP manager (tell the agent to send information to the manager).
- Compile the agent's Management Information Bases (MIBs) into the manager (tell the manager how to interpret information sent by the agent).

8.3.1 Configuring IP Address to Receive Notifications

Configuring an IP address for notifications is referred to as *Subscribing to Notification Services*. Up to ten IP addresses can be configured. SNMP monitoring systems need to compile and install the ALPHA-NOTIFICATION-MIB. Please refer to the user guide of the SNMP manager for this process.

Figure 51: SNMP Destination Page:

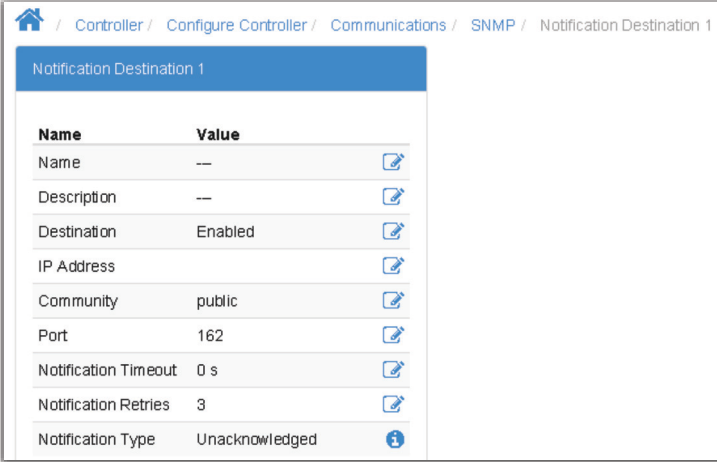


The screenshot shows the SNMP configuration page. At the top, there is a breadcrumb trail: Home / Controller / Configure Controller / Communications / SNMP. Below this is a blue header bar labeled "SNMP". The main content is a table with the following columns: Name, Destination, IP Address, Community, Notification Type, and a More Details icon (a blue square with a white pencil and magnifying glass). The table contains 10 rows, each representing a notification destination from 1 to 10. All destinations are currently "Enabled", have a "public" community, and are set to "Unacknowledged" notification type.

Name	Destination	IP Address	Community	Notification Type	
Notification Destination 1	Enabled		public	Unacknowledged	
Notification Destination 2	Enabled		public	Unacknowledged	
Notification Destination 3	Enabled		public	Unacknowledged	
Notification Destination 4	Enabled		public	Unacknowledged	
Notification Destination 5	Enabled		public	Unacknowledged	
Notification Destination 6	Enabled		public	Unacknowledged	
Notification Destination 7	Enabled		public	Unacknowledged	
Notification Destination 8	Enabled		public	Unacknowledged	
Notification Destination 9	Enabled		public	Unacknowledged	
Notification Destination 10	Enabled		public	Unacknowledged	

Clicking one of the more details icons on the right-side of the row takes you to an edit page to configure the appropriate fields.

Figure 52: Destination 1 More Information Page:



The screenshot shows the "Notification Destination 1" configuration page. At the top, there is a breadcrumb trail: Home / Controller / Configure Controller / Communications / SNMP / Notification Destination 1. Below this is a blue header bar labeled "Notification Destination 1". The main content is a table with the following columns: Name and Value. The table contains 10 rows, each representing a configuration field for the notification destination. Each row has an edit icon (a blue square with a white pencil and magnifying glass) on the right side. The fields and their values are: Name (---), Description (---), Destination (Enabled), IP Address (---), Community (public), Port (162), Notification Timeout (0 s), Notification Retries (3), and Notification Type (Unacknowledged).

Name	Value	
Name	---	
Description	---	
Destination	Enabled	
IP Address	---	
Community	public	
Port	162	
Notification Timeout	0 s	
Notification Retries	3	
Notification Type	Unacknowledged	

Clicking the edit icon on the IP address row allows you to insert an IP address of the monitoring destination.

NOTE: For detailed information on using SNMP, see the *SNMP Integrator Guide (0350099-J0)* on the Alpha website, www.alpha.ca.

9 FXM HP Systems

This section provides a brief overview of the components and functions within a typical FXM HP system. A basic FXM HP system usually consists of an FXM HP, a battery and a load, but can also include other components.

9.1 Guidelines for Setting Up the FXM HP System

The following section contains basic guidelines for setting up the FXM HP system. System setup consists of four parts: AC system inspection, battery inspection, setting up the system and testing the system. System setup should only be conducted by a qualified technician.

PREREQUISITE: Perform an inspection of the power system to confirm that the mechanical and electrical requirements and parameters are within specification. Pay special attention to the battery to ensure it is installed safely and correctly, and that the battery terminals are torqued to specification.

1. Make sure all power to the system is off.
2. Make sure the battery polarity is correct. Use a voltmeter if necessary to confirm.
3. Install the FXM HP.
4. Turn on the AC to the FXM HP and allow it to start up.
Verify that the system starts up, and the controller turns on.
5. Confirm the battery settings on the controller: capacity, charge limit, the Peukert exponent, etc.
6. Check that the battery polarity is correct and turn on the breaker for the batteries.
7. Follow the initial battery charge procedure as indicated in the manufacturer's instructions.

The FXM HP system is operating normally. There may or may not be active alarms depending on system configuration.

Perform tests to confirm that the system is operating properly. Specific tests to perform will depend on the system configuration but may include:

- Correct AC input voltage and DC voltage
- Battery test
- Relay test
- Battery disconnect operation
- Alarm test

9.1.1 The System Mode

The System Mode indicates the state of the FXM HP. The mode can be observed in the System Summary banner (if set as a preference) or on the System Status page.

In a system operating normally, the **System Mode** will be **Line**. The Charging value will show **Float** which indicates the battery is floating.

In a system that is charging, Charging Mode value either be **Bulk** (battery is charging at constant current) or **Absorption** (battery is in the absorption phase of charging).

In a system that is providing backup power, the **System Mode** will be in **Inverter** mode (AC line has failed, or not within acceptable limits).

Figure 53: System Mode

FXM 2000 (FXMHP 120V-48V/378)			
FXM MODE Line	AC OUTPUT VOLTAGE 115.0 V	BATTERY VOLTAGE 36.4 V	BATTERY TEMPERATURE 23.0 °C
CHARGING Float	AC OUTPUT FREQUENCY 60 Hz	BATTERY CURRENT 0.0 A	ESTIMATED BATTERY RUNTIME --- h

When the **System Mode** shows **Error**, then the controller is unable to communicate with the FXM HP module. If this value persists for more than a minute or so, it may indicate that the FXM HP is not configured or working properly.

The FXM HP can be in one of the following modes:

Table 11: FXM HP Operating Mode

Mode	Description
Standby	The unit is switched on and waiting for the line power to qualify or resolution of pending faults/alarms.
Retransfer	The unit is transferring to Line mode from the following modes: Inverter, Shutdown or Standby.
Boost1 and Boost2	The unit transformer is increasing output line voltage due to the input voltage being lower than specification.
Line	The unit is switched on and line power is provided to the load.
Buck1 and Buck2	The unit transformer is decreasing output line voltage due to the input voltage being higher than specification.
Inverter	The unit is providing backup battery power to the load.
Bypass	The unit is feeding input directly to the load without providing any features such as automatic voltage regulation or a backup power.
Shutdown	The output is turned off via a user input or via web/LCD interface, and the power to the load is disconnected. For safety reasons, the AC Input Breaker and DC Breaker should be opened before servicing the unit.
Fault	The unit has a recoverable fault. AC and DC outputs are off until the fault is cleared.
Permanent Failure	The unit has a permanent failure. Example: backfeed relay failure.
Battery Test	The unit is running a Battery Test. The unit is providing battery power to the load.

9.2 FXM HP System Functions

9.2.1 Modules, Inventory and System Functions

To setup an FXM system on the controller, there must be configurations completed for various parts of the system like Modules, Inventory and System Functions. This section will explain the terms which will assist in navigating the menu structure.

Modules

A module is a device that communicates information. Most modules in a controller system will be CAN devices such as the FXM HP module (called “FXM ADIO”) and other ADIOs. Detailed information about modules can be found under the top level **Modules** menu.

The FXM ADIO module is a independent device that handles all the real time control functions of the inverter. The front panel LCD UI can be thought of as the communications controller, often referred to as “the controller”. The controller communicates with the various modules of the system to fulfill the monitoring and control functions.

Inventory

An inventory item is an item that is directly involved in the flow of power through the system. For example, a battery is an inventory item but a controller or an ADIO is not. Setting up the inventory of a system focuses on the monitoring. The control of the system is done under advanced functions. Inventory of a system can be found under the **System > Inventory** menu. Battery, shunts, and transducers are inventory items applicable to the FXM HP.

System Functions

System functions are the major features of the system. Some examples are:

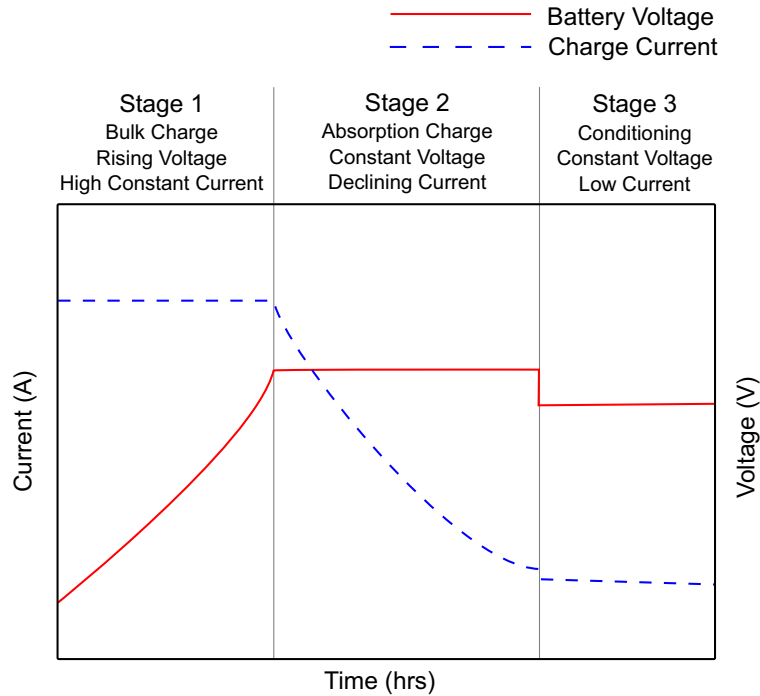
- Battery Charging
- Battery Test
- Battery Runtime and Health
- Temperature Compensation
- AC Output
- Inverter Control
- Load Shedding Relays
- External Fan
- Keep Alive

System functions can be found under **System > System Functions**. The system functions interact with the battery inventory item and the FXM ADIO module. Once these are configured you can test the system functions to ensure that the system is working as intended.

9.2.2 Battery Charging

The controller applies a typical three-stage charging cycle including Bulk Charging, Absorption Charging and Conditioning which is sometimes called float charging.

Figure 54: Three-Stage Charging Cycle



Bulk Charging

After the bulk charging stage, the battery should be in a 70%-90% state of charge. In the **Bulk Charging**, the charging current is limited to the Charge Current Limit setting.

Absorption Charging

After the absorption charging stage, the battery should be in a 95%-98% state of charge. In the **Absorption Charging** menu, you have the option to charge the battery at a voltage higher than the float voltage. The higher voltage is used to speed up the absorption charging stage after a prolonged AC power failure.

Float Charging

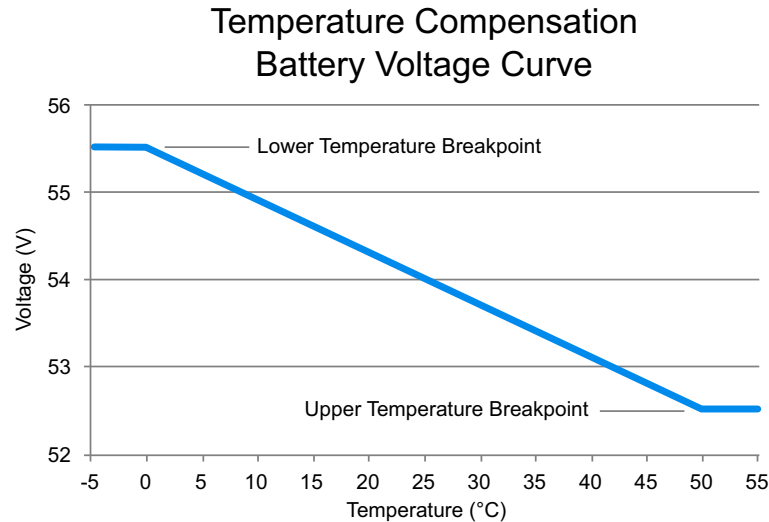
The float charging stage brings the batteries to 100% state of charge and maintains it there. When the system is in the float stage it is usually at the **Float Voltage**.

9.2.3 Battery Temperature Compensation

Temperature Compensation (Temp Comp) is used to prolong battery life and help prevent thermal runaway. When battery temperature compensation is enabled, the controller uses the battery temperature to calculate an offset which is applied to the battery voltage.

A typical temperature compensation curve for a 48V battery system is shown in the following figure.

Figure 55: Temperature Compensation Voltage Graph



Battery performance and life expectancy are directly related to the battery ambient temperature.

Thermal runaway occurs if the internal temperature rises due to overcharge, high ambient temperature or internal fault. Temp Comp automatically adjusts the float voltage as the battery temperature changes to protect the battery from thermal runaway.

The Temp Comp function adjusts the system voltage every two seconds, as the temperature changes, and provides for a maximum voltage change of 0.1V over this interval. Temp Comp occurs at standard rates commonly referred to as slope-compensation settings.

The slope of the Temp Comp curve in either mV/°F/Cell or mV/°C/Cell can be set via the **System > System Functions > Temperature Compensation**. The value is set based on the battery manufacturer's information.

If the battery temperature probes appear to be disconnected or broken, then the Temp Comp function calculates the enabled setpoints as if the temperature reached the **Upper Temperature Breakpoint**.

9.2.4 Battery Test

Battery test is used to determine the **Estimated State of Health** of the battery by discharging it to a certain state.

Definitions

- Battery Test Termination Voltage — The voltage threshold at which the test normally ends.
- Battery Test Timeout — The maximum time the test can run before it is stopped.
- Battery Test Alarm — The battery test is active.

There are three ways to start a battery test:

- Manual Battery Testing — Battery Test can be started by clicking in the Start Manual Battery Test button.

- Automatic Testing — Battery Test can be scheduled to start automatically and periodically.
- Remote Triggered Battery Testing — Battery Test can be triggered to start by the state of a user input.

Using the Battery Test

If the test is started when the battery is fully charged, the results of the battery capacity estimate will be more accurate. Use charge current control to limit the battery recharge current to the battery manufacturer's specified maximum value.

During a test, the **Estimated State of Charge** and **Estimated Battery Runtime** hours can be viewed via the **System > Status** menu or the **System > System Functions > Battery Runtime and Health Estimation** menu.

Battery Test Initiation

When the test begins, an entry is made in the event log. If the **Battery Test Alarm** has been enabled, it would be activated to provide a warning to indicate that a battery test is in progress. The FXM mode is changed to Inverter mode to allow the battery to discharge by providing power to the AC load. Battery Test will run for the period set as timeout or until the battery test termination voltage is reached.

Activity During Battery Test

Temperature compensation features are suspended during a battery test. When the battery is discharging, the battery test alarm is active. Battery state of health estimation begins at 3% of DOD, but is not displayed unless DOD > 20%; the point at which reasonable accuracy can be assured.

Conditions to Watch for During Battery Test

If the voltage drops below 46V (23V for 24 V battery system) before or when 3% depth of discharge is reached, the test is aborted and the battery health is set to 0% (resulting in a Battery Health Low alarm). This provides an indication that the battery is very weak. Battery state of health must be manually reset to 100% before the next battery test is started, so that the battery monitor can properly estimate the battery health.

Canceling Battery Test

Battery Test mode can be canceled by stopping the test manually. To stop the battery test manually go to **System > FXM System > System Functions > Battery Test** and press the **Stop Manual Battery Test** button.

Battery Test Completion

Once the battery begins to charge, the recharge cycle begins. Live battery recharge information is available via the **System > FXM System > System Functions > Battery Runtime and Health Estimation** menu. The test is considered complete once the battery begins to charge. This is due to either, the test ending from timeout, the system reaching the termination voltage or from an abort condition.

9.2.5 Battery Runtime and Health Estimation

If **Battery Estimation** is enabled, the controller calculates an **Estimated State of Charge** (SOC), and an **Estimated Battery Runtime** remaining (RTR) at all times. It is not always practical to estimate these

values. For example, if the system goes into a charging stage immediately after a restart, there is no way to estimate the SOC or RTR.

The accuracy of the estimated battery health improves as the battery undergoes more discharge cycles and it also improves with deeper discharges.

If a battery discharge occurs that goes below an SOC value of 80%, then the **Battery Runtime and Health Estimation** function creates a **Last Battery Discharge Summary**, a **Last Battery Recharge Summary** and recalculates the **Estimated Battery Health**.

9.2.6 AC Output

AC Shutdown

AC Shutdown is used to shut off the AC output power. When the unit is in shutdown mode, the inverter is turned off. Neither the AC line nor inverter power is supplied to the load.

AC Output can be turned off by a trigger source such as a user input. When the trigger source is active, the unit goes into shutdown mode. Once the trigger source is inactive, the unit must be re-started manually by going to **System > FXM-HP > Configure System** and clicking the **Start Up** command.

AC Output can also be turned off manually by going to **System > FXM-HP > Configure System** and clicking on the **AC Output Shutdown** command. If the AC Output is turned off manually, there are two options for restarting the FXM HP output:

- **Manual On:** The unit remains in shutdown mode. The output of the unit must be turned on manually by going to **System > FXM-HP > Configure System** and clicking on the **Start Up** command.

NOTE: AC output will be off due to shutdown. If the router is on, the output of FXM communication will be lost. To turn on output local access will be required.

- **Auto On After Delay:** After the unit is in shutdown mode, the unit will restart automatically after a delay.

Output Relay Status

The Output Relay can be configured for an external relay, to disconnect the load when the AC output voltage is out of the predefined range.

The Output Relay selects the relay to be activated when the AC output voltage is out of range.

Upper Disconnect Voltage and **Upper Reconnect Voltage** define the upper range of activating/deactivating the selected relay.

Lower Disconnect Voltage and **Lower Reconnect Voltage** define the lower range of activating/deactivating the selected relay.

9.2.7 Inverter Control

The unit goes to Inverter mode when there is no AC Input power, or the AC Input is not qualified. For the Inverter to work properly, there must be a fully charged battery and the unit must be configured as Normal UPS.

The Inverter Control configuration table has the following fields:

Table 12: Inverter Control Configuration Table

Name	Definition
Maximum Time On Inverter Enable	Controls the function of turning off the Inverter after running for a configured period. The intent of this function is to conserve battery power while giving enough time for the load to be turned off properly.
Maximum Time On Inverter	Defines the maximum time in seconds the inverter will run before going to Standby mode.
Inverter Shutdown Voltage	Defines the lower battery voltage limit when the inverter will be turned off. The unit goes to Standby mode. Once the Inverter has been turned off, the unit waits for the AC input power.
Inverter Manual Start Up Voltage	Define the minimum battery voltage which the inverter can be started manually.
Close to Inverter Shutdown	Alarm is activated when the inverter is running with the battery discharged to within 5% of the Inverter Shutdown Voltage.

9.2.8 Load Shedding Relays

A Load Shedding Relay can be configured to trigger a relay after the trigger condition is true for the configured time period.

The Load Shedding Relays table gives a status summary of all relays. The **Add Load Shedding Relay** button is used to create a new Load Shedding Relay.

The Load Shedding Relays configuration table has the following fields:

Table 13: The Load Shedding Relays Configuration Table (Sheet 1 of 2)

Name	Definition
Name	Name of this relay.
Description	Description of this relay.
Relay Enable	Enable the function of this relay.
Relay	Select the relay to energize.
Relay Trigger Source	Defines the condition to activate this relay.
Activation Delay	Defines the time delay before energizing the relay after the trigger source is activated. Set to 0 if no delay is needed.

Table 13: The Load Shedding Relays Configuration Table (Continued) (Sheet 2 of 2)

Name	Definition
Time Periods 1	Defines the first time of day period. During this period, the loading shedding relay will not be activated, and the relay will be de-energized. Once the time is outside this time of day period, the relay will resume to function. If no Time of Day period is needed, set to ---
Time Periods 2	Defines the second time of day period. During this period, the loading shedding relay will not be activated, and the relay will be de-energized. Once the time is outside this time of day period, the relay will resume to function. If no Time of Day period is needed, set to ---.

9.2.9 External Fan

External Fan is used to trigger a designated relay when the temperature is above a threshold setting. This relay can be wired to turn on an external fan.

The External Fan configuration table has the following fields:

Table 14: External Fan Configuration Table

Name	Definition
Relay	Selects the relay to be activated when the temperature is out of range.
Temperature Sensor	Selects the temperature input.
Fan On Temperature	Defines the temperature to activate the relay.
Fan Off Hysteresis	Defines the temperature to deactivate the relay.

9.2.10 Keep Alive

Keep Alive is used to detect a communication failure and to provide a method to restore communication. A reset temporarily removes power and resets the local communication equipment powered by this unit. If the Keep Alive function is enabled, the FXM HP waits for the initial **Keep Alive Startup Delay** period before initiating communication with the destination IP address.

Detecting Communication Failure

After the initial Startup Delay, the FXM HP pings the destination IP address every Protocol Interval seconds. If no response is received within the Protocol Timeout period, the unit waits for Protocol Interval seconds before sending another ping. After retrying for Maximum Protocol Retries times and pinging still fails, the FXM HP runs the selected Keep Alive Action.

Running Failure Action

After the communication fails, the unit runs the selected Keep Alive Action to shutdown the AC Output. This function turns off the AC power to reset the local communication equipment. After the output power is restored, the unit waits for Keep Alive Startup Delay before retrying to ping the destination IP address.

If the communication still fails after running the selected Keep Alive Action for Keep Alive Maximum Action Retries, the Keep Alive function goes to a Failure state. In the Failure state, the Keep Alive Failure Alarm is activated and the unit will stop pinging the destination IP address until Keep Alive Failure is reset.

The Keep Alive configuration table has the following fields:

Table 15: Keep Alive Configuration Table

Name	Definition
Keep Alive Enable	Controls the function of running failure action after detecting communication failure.
Keep Alive Startup Delay	Defines the initial time delay at startup before starting communication.
Keep Alive Destination IP Address	Defines the destination IP address.
Keep Alive Protocol Timeout	Defines the timeout period for the protocol.
Keep Alive Protocol Interval	Defines the retry interval
Keep Alive Maximum Protocol Retries	Defines the number of retries before running the action.
Keep Alive Action Duration	Defines the duration the AC output will be turned off.
Keep Alive Maximum Action Retries	Defines the number of retries turning the AC output off.
Keep Alive Failure	Alarm is triggered when the communication failure is detected after maximum number of retries.
Keep Alive Failure Restart Delay	Defines the time delay between a failure and the when the next communication test is restarted.

9.3 Creating a FXM HP System Manually

On a controller, if there is no FXM HP system defined, you can easily create the inventory items needed to monitor and control a FXM HP system. There are three steps to creating a new FXM HP system.

1. Create the FXM HP system and other inventory items, and then configure the inventory to use the inputs and relays to monitor the system.
2. Configure each of the system function to correctly control the FXM HP system and manage the battery.
3. Adjust threshold, enable/disable alarm and set up any remote alarm reporting using alarm relays and/or SNMP notification.

9.3.1 Quick Reference for Configuring a FXM HP System

The following figure shows the key configuration settings for a FXM HP system that should be set or checked so that the system operates correctly.

There are many optional and alarm reporting settings that can also be configured.

Figure 56: Quick Reference for Configuring a FXM System

Controller > Inventory	System > FXM System > System Functions > Charging > Primary Charge Control	System > FXM System > System Functions > Load Shedding Relays
Create FXM System	Turn Off Charger Turn On Charger at Max Current Charge Current Limit (C/X)	Load Shedding Relay Enabled = Enabled Relay = FXM ADIO C4 Relay Trigger Source = AC Power Outage Relay Activation Countdown = 120 minutes Time Period 1 = --- Time Period 2 = ---
System > FXM System > Configure System	System > FXM System > System Functions > Charging > Absorption Charging	Controller > Advanced Functions > Scheduler
Configure FXM System Start Up AC Output Shutdown Bypass Float Voltage = 54V System Type = Normal UPS Low Battery Threshold = 40% AC Input Frequency = Auto Detect AC Input Qualification 3 sec AC Input Sense = Normal Automatic Voltage Regulation = Enabled AVR Disabled High Limit = 126V AVR Disabled Low Limit = 114V	Elevated Absorption Charging = Enabled Arming Threshold = 48V Absorption Voltage = 55V Absorption Termination Threshold = 5A Absorption Timeout = 1.0h	Days = All Days Time Period 1 = 6:00 AM - 9:00 AM Time Period 2 = 3:00 PM - 6:00 PM
System > FXM System > Configure System > Alarms	System > FXM System > System Functions > Temperature Compensation	System > FXM System > System Functions > External Fan
Low Battery + No Line 1 = FXM ADIO: C2 Low Battery + No Line 2 = FXM ADIO: C3 On Battery = FXM ADIO: C1	Temp Comp In Float = Enabled Temp Comp in Absorption = Enabled	Relay Temperature Sensor Fan On Temperature = 131 deg F Fan Off Temperature = 113 deg F
Controller > Configure Controller > Alarms and Alarm Summary Relays	System > FXM System > System Functions > Battery Test	System > FXM System > System Functions > Keep Alive
Controller Critical Relay = FXM ADIO C5 Controller Major Relay = FXM ADIO C5 Controller Minor Relay = FXM ADIO C5	Start Manual Battery Test Remote Battery Test = Enabled Trigger Input: FXM ADIO:S1	Keep Alive Enable = Disabled Start Up Delay = 15 sec Destination IP Address Ping Protocol Timeout = 2 sec Ping Protocol Interval = 5 sec Maximum Retries = 3 Keep Alive Action = Reset AC Power Action Duration = 5 sec Maximum Action Retries = 5 Failure Restart Delay = 40 sec
System > FXM System > Inventory > Battery > Battery String	System > FXM System > System Functions > Battery Runtime and Health	Module > FXM ADIO
Battery Voltage = FXM ADIO:Battery Source Battery Current FXM ADIO:Battery Current Battery Temperature Source: FXM ADIO Battery Temperature Capacity Rating = 100 A-h Peukert Exponent = 1.00 Breaker/Fuse Source: FXM ADIO: Battery Breaker Open	Battery Estimation = Enabled Load Model = Resistive	Digital Input S1 Name = Battery Test Digital input S2 Name = User Input Alarm Digital Input S3 Name = Shutdown Relay C1 Name = On Battery Relay C2 Name = Low Battery + No Line 1 Relay C3 Name = Low Battery + No Line 2 Relay C4 Name = Timing Relay 1 Relay C5 Name = Controller Alarm Relay C6 Name = External VDC
	System > FXM System > System Functions > AC Output Shutdown	
	Shutdown Trigger Source = FXM ADIO:S3 Shutdown Operation = Manual Shutdown Auto On Delay = 30 seconds	
	System > FXM System > System Functions > Output Relay Configuration	
	Relay Upper Disconnect Voltage = 135V Lower Disconnect Voltage = 100V	
	System > FXM System > System Functions > Inverter Control	
	Max Time on Inverter Enabled = Disabled Max Time on Inverter = 300 seconds Inverter Shutdown Voltage = 42V Manual Start Up Voltage = 50V	

9.3.2 FXM HP - Default Values

When a FXM HP system is created, all user configurable parameters are set to their default values.

Table 16: FXM HP - Default Values (Sheet 1 of 4)

Parameters	Default Settings
System Type	Normal UPS
Battery Float Voltage	54.0V (48V) / 27V (24V)
AC Input Frequency	Auto Detect
AC Input Qualification Time	3 seconds
AC Input Sense	Normal
Automatic Voltage Regulation	Enabled
AC Input High Limit (AVR Disabled)	132V (120V) / 253V (230V)
AC Input Low Limit (AVR Disabled)	108V (120V) / 207V (230V)
Battery Capacity Rating	100Ah
Battery Open Circuit Voltage	51.4V (48V) / 25.7V (24V)
Battery Peukert Exponent	1.00
Battery Runtime Low Alarm	60 minutes
Battery Health Low Alarm	70%
Battery Temperature High Alarm (°C)	75
Battery Temperature Low Alarm (°C)	-20
Charging Current Limit Amps	15A (1100/2000), 10A (650)
Elevated Absorption Charging	Enabled
Elevated Absorption Arming Threshold	48V (48V) / 24V (24V)
Elevated Absorption Voltage	55V (48V) / 27.5V (24V)
Elevated Absorption Termination Threshold	5A
Elevated Absorption Timeout	1.0Hr
Temperature Compensation Slope (mV/°C/Cell)	-2.5

Table 16: FXM HP - Default Values (Continued) (Sheet 2 of 4)

Parameters	Default Settings
Temperature Compensation in Float	Enabled
Temperature Compensation in Absorption	Enabled
Temperature Compensation Lower Voltage Breakpoint	52.5V (48V) / 26.25V (24V)
Temperature Compensation Upper Voltage Breakpoint	55.5V (48V) / 27.75 (24V)
Battery Test	Enabled
Battery Test Trigger Input	User Input S1
Battery Test Termination Voltage	49V (48V) / 24.5V (24V)
Battery Test Timeout	1 Hour
Battery Estimation	Enabled
Battery Estimation Load Model	Resistive
AC Output Shutdown Trigger Input	User Input S3
AC Output Shutdown Operation	Manual
AC Output Shutdown Auto On Delay	30 seconds
AC Output Relay	Unassigned
AC Output Upper Disconnect Voltage	135V (120V) / 239V (230V)
AC Output Upper Reconnect Voltage	130V (120V) / 254V (230V)
AC Output Lower Reconnect Voltage	105V (120V) / 197V (230V)
AC Output Lower Disconnect Voltage	100V (120V) / 192V (230V)
Inverter Maximum Time On Enable	Disabled
Inverter Maximum Time On	5 minutes
Inverter Shutdown Voltage	42V (48V) / 21V (24V)
Inverter Manual Start up Voltage	50V (48V) / 25V (24V)
External Fan Relay	Unassigned
External Fan Temperature Sensor	Unassigned

Table 16: FXM HP - Default Values (Continued) (Sheet 3 of 4)

Parameters	Default Settings
External Fan On Temperature (°C)	55
External Fan Off Temperature (°C)	45
Keep Alive Enabled	Disabled
Keep Alive Destination IP Address	Unassigned
Keep Alive Startup Delay	15 seconds
Keep Alive Ping Timeout	2 seconds
Keep Alive Protocol Retries Interval	5 seconds
Keep Alive Protocol Maximum Retries	3
Keep Alive Action	Reset AC Power
Keep Alive Action Duration	5 seconds
Keep Alive Action Maximum Retries	5
Keep Alive Action Failure Restart Delay	40 seconds
Low Battery Alarm Threshold	40%
Programmable Dry Contact #1	On Battery Alarm
Programmable Dry Contact #2	Low Battery + No Line 1 Alarm
Programmable Dry Contact #3	Low Battery + No Line 2 Alarm
Programmable Dry Contact #4	Timer 1 Relay
Programmable Dry Contact #5	Controller Alarms
User Input #1	Battery Test Trigger
User Input #2	User Alarm Trigger
User Input #3	AC Shutdown Trigger
Time Period 1 Days	All Days
Time Period 1 Start Time	6:00AM
Time Period 1 End Time	9:00AM

Table 16: FXM HP - Default Values (Continued) (Sheet 4 of 4)

Parameters	Default Settings
Time Period 2 Days	All Days
Time Period 2 Start Time	3:00PM
Time Period 2 End Time	6:00PM
Timer 1 Enabled	Enabled
Timer 1 Relay	Dry Contact #4
Timer 1 Trigger	AC Power Outage Status
Timer 1 Activation Delay	2:00:00
Timer 1 Time Period #1	Unassigned
Timer 1 Time Period #2	Unassigned
Timer 2 Enabled	Disabled
Timer 2 Relay	Unassigned
Timer 2 Trigger	AC Power Outage Status
Timer 2 Activation Delay	2:00:00
Timer 2 Time Period #1	Unassigned
Timer 2 Time Period #2	Unassigned
Timer 3 Enabled	Disabled
Timer 3 Relay	Unassigned
Timer 3 Trigger	AC Power Outage Status
Timer 3 Countdown	2:00:00
Timer 3 Time Period #1	Unassigned
Timer 3 Time Period #2	Unassigned

9.3.3 Creating a FXM HP System

An FXM HP System is pre-configured on a brand-new unit. However, if the FXM HP system is removed, you can create a new system, or import a configuration file containing a FXM HP system

from another controller. In the current release, only a single FXM HP system is supported; if a system already exists on the controller, the option to create a new FXM HP system will not be available.

A new FXM HP system can be created via the **Controller** menu from either the LCD touchscreen or the web interface. Both have wizard assistance to help step you through the process to create the new system. You can create either a 120V or 240V system with a 24V or 48V battery system.

The FXM HP system will also be created with a reasonable set of defaults and associated alarms.

You can configure the alarms associated with the system. You can enable or disable the alarms, change the priority, map relays to the alarms, and where applicable, modify the thresholds.

To create a FXM HP system:

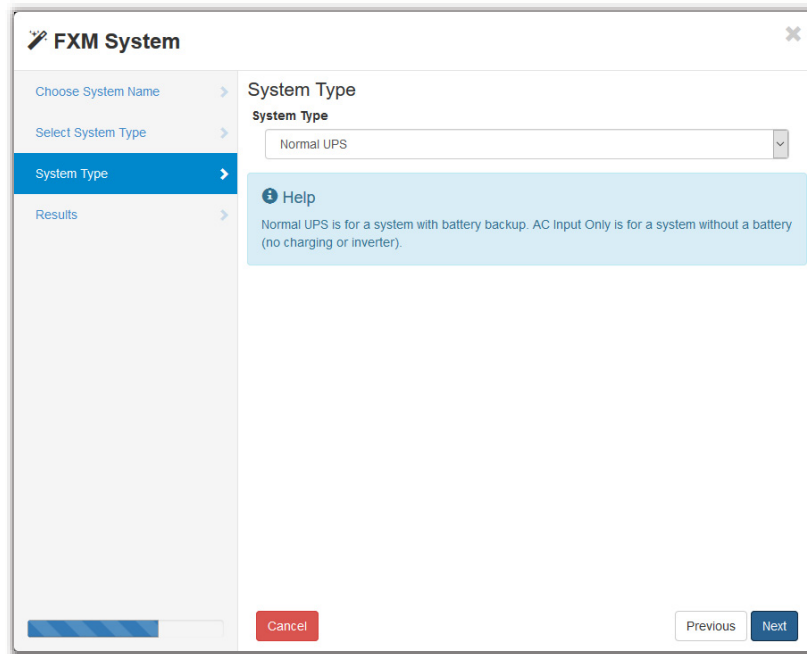
1. Go to **Controller > Inventory** and use the **Create FXM System** wizard.

The screenshot shows the 'FXM System' wizard window. The title bar reads 'FXM System'. On the left is a navigation pane with four items: 'Choose System Name' (highlighted in blue), 'Select System Type', 'System Type', and 'Results'. The main content area is titled 'Choose System Name' and contains a 'Name' input field with the text 'FXM'. Below the input field is a 'Help' section with an information icon and the text: 'The editable name of this item.' At the bottom of the window, there are three buttons: 'Cancel' (red), 'Previous' (grey), and 'Next' (blue).

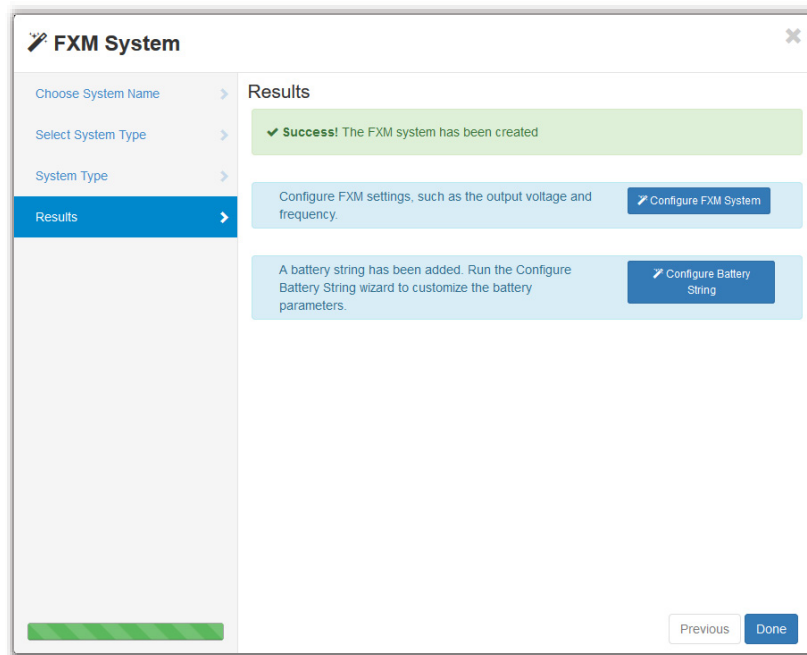
2. Select the **System Type** from the drop-down menu. Click **Next**.

The screenshot shows the 'FXM System' wizard window at the second step. The title bar reads 'FXM System'. The navigation pane on the left now has 'Select System Type' highlighted in blue. The main content area is titled 'Select System Type' and features a 'Select System Type' drop-down menu with 'FXM-HP 120V-48V' selected. Below the menu is a 'Help' section with an information icon and the text: 'Select the type of system to create. If there is an unassigned FXM module that is not comms lost, the controller will automatically decide which system is compatible with the module.' At the bottom of the window, there are three buttons: 'Cancel' (red), 'Previous' (grey), and 'Next' (blue).

3. Confirm the system type detected from the hardware. Click **Next**.



4. Select the **Configure Battery String** option to configure the battery, or select **Done** if finished. The battery can be configured later by going to **FXM System > Inventory > Battery**.



Creating a FXM System from a Configuration File

A system can be created by importing from a configuration file. See the “Importing a System” section in the CXC HP Controller Manual.

Configure the Basic FXM System Settings

The Configure System page has five tables (Configuration, System Properties, AC Input, AC Output and Alarms) with some basic settings that must be configured.

To setup an FXM HP system:

1. Go to **System > Configure System**.
2. In the **Configuration** table, configure the following:
 - a. Set the system name, description, system number and serial number.
 - b. Set the system float voltage.
3. In the **System Properties** table set the low battery threshold so it will trigger the **Low Battery Warning** and **Low Battery + No Line** alarms.
4. Set the **Power Outage Alarm Delay** so that power outages shorter than delay setting will be ignored. **AC Power Outage** and **On Battery** alarms will not be triggered. Short power outage events will be logged in the **Power Outage Logs**.
5. In the **AC Input** table, set the **AC Input Sense**.
6. In the **AC Output** table, set the **Automation Voltage Regulations (AVR)** mode.
7. In the **Alarms** table, configure the alarms.

Configure Output Voltage and Frequency for Bypass

Several parameters of the FXM HP must be configured if the system is to be put into Bypass mode. This is to ensure that the power to the load would not be disrupted.

To configure an FXM HP system for Bypass mode:

1. Go to **System > Configure System**.
2. In the **Configuration** table, click on **Configure FXM System** wizard.
3. Click **Next** to start the wizard.
4. Select **System Type**: Normal UPS is for a system with battery backup, and AC Input Only is without battery.
5. Select **AC voltage** and **AC Frequency**.
6. Click **Next** to complete the configuration.

9.3.4 Configure the Battery Parameters

The system is only permitted to have a single battery group.

ATTENTION: *If the system does not have batteries connected, the battery string must be deleted. This is important to have the system mode reported correctly. Go to **System > Inventory > Battery**, and then remove the battery string.*

If a battery is required, configure it as follows:

1. Go to **System > FXM System > Inventory > Battery**. On the Batteries table, you will see a list with one battery.
2. Click the more details icon on the right-side of the table.
3. Click the edit icon on the right-side of the **Battery Configuration** table.
4. In the **Configuration** table assign the battery a name and description if required.
5. Select the **Battery Voltage Source**. This is the battery voltage reading from the FXM ADIO module.
6. Select the **Battery Current Source**. This is the battery current reading from the FXM ADIO module.
7. Configure the battery temperature values. See the following section for instructions on how to do this.
8. Configure the battery capacity. This value is usually available from the battery specification sheet. Use the capacity at the 20-hour rate (C/20).
9. Configure the open circuit voltage. This value is sometimes available from the battery specification sheet. If it is not, leave it at the default value.
10. Use the wizard to configure the Peukert exponent. This value usually available from the battery specification sheet.

If the Peukert exponent (n) is not supplied in the battery specification, calculate it by the equation:

$$n = \frac{[\log(T_2) - \log(T_1)]}{[\log(I_1) - \log(I_2)]}$$

where T is the discharge time in hours and I is the corresponding discharge current in amps. Both T and I are often available in the battery specification sheet.

11. In the **Alarms** table, configure the alarms.

9.3.5 Configure the Battery Temperature Sensors

The battery can have any number of battery temperature sensors. Depending on your requirements you can choose to have only a single temperature reading for your battery, or one for each battery block, or one for each battery cell.

To add and configure battery temperature sensors:

1. Go to **System > FXM System > Inventory > Battery > Battery String**. On the **Temperatures** table, click the **Add Temperature Value** button. The table will be populated with a new line for temperature value.
2. Click the more details icon on the right-side of the line for the new temperature value.
3. A new page displays with information about the new temperature value. In the **Configuration** table you can enter an optional name and description if desired.
4. It is mandatory to select a **Battery Temperature Source** for the temperature value. Click the more details icon and select the desired temperature input. The drop-down list displays all available temperature inputs. The FXM HP has one temperature probe, used for battery temperature, from the FXM ADIO module.
5. In the **Status** table, verify that the temperature is now reading a temperature value.
6. Repeat these steps for each temperature value required. When finished navigate back to the **Battery** page.

In the **Temperatures** table on the **Battery** page, you should now see a list of temperature values. The battery **Status** table should show the minimum, average and maximum temperature values as determined from the list of temperatures. The system battery temperature should now show a valid reading for battery temperature.

9.3.6 Configure the Charging System Function

You can enable/disable and set the charging voltage in the absorption charging state. If you disable Elevated Absorption Charging or the arming threshold was not reached, then the absorption charging stage will be done at the float voltage. You can configure **Elevated Absorption Charging** to terminate on a timeout and a low current threshold.

Absorption charging, at an increased voltage, is normally done for deep discharges only so there is an **Absorption Arming Threshold**. A battery discharge must reach a voltage below the **Absorption Arming Threshold** for **Elevated Absorption Charging** to be activated on the recharge.

To configure the Charging System:

1. Go to **System > FXM System > System Functions > Charging**.
2. In the **Primary Charge Current Control** table, click on **Turn Off Charger** button to turn off the charger.
3. Click on **Turn on Charger at Maximum Current** to set the Nominal Charging current limit.
4. To set the current limit to a specific value, set the **Charge Current Limit** to an appropriate value. See your battery manufacturers' data sheet for charging recommendations.
5. Confirm the value of **Charge Current Limit Amps** is correct.

9.3.7 Configure the Elevated Absorption Charging System

To configure the Elevated Absorption Charging system:

1. Go to **System > FXM System > System Functions > Charging**.
2. From the **Automatic Elevated Absorption Charging Configuration** table, enable **Elevated Absorption Charging**.
3. Set the **Elevated Absorption Arming Threshold** to a voltage that indicates a deep enough discharge to warrant absorption charging at a higher voltage.
4. Set the **Elevated Absorption Voltage** to a value recommended by the battery manufacturer.
5. Set the **Elevated Absorption Termination Threshold** in amps.
6. Set the **Elevated Absorption Timeout** in hours.
7. From the **Elevated Absorption Charging Status** table, click on the **Start Manual Elevated Absorption Charging** to manually launch Elevated Absorption Charging.

9.3.8 Configure the Temperature Compensation System Function

The **Temperature Compensation** function uses the battery temperature to adjust battery voltage. The default value for temperature compensation is $-2.5 \text{ mV}/^\circ\text{C}/\text{Cell}$ ($-1.5 \text{ mV}/^\circ\text{F}/\text{Cell}$).

To configure the Temperature Compensation:

1. Go to **System > FXM System > System Functions > Temperature Compensation**.
2. Enable/disable **Temp Comp in Float** and **Temp Comp in Absorption**.
3. Set the **Slope** based on the battery manufacturer's information.
4. Set the **Upper Temperature Breakpoint Voltage** to a value below the float voltage.
5. Set the **Lower Temperature Breakpoint Voltage** to a value above the float voltage.
6. Adjust the values and enable/disable the **Temp Comp Sensor Fail** and **Temp Comp Voltage Warning** alarms.

9.3.9 Running Battery Tests

The **Battery Test** function allows the unit to test the charge and health of the battery.

Run a Manual Battery Test

To run a manual Battery Test:

1. Go to **System > FXM System > System Functions > Battery Test**. Note that you must have a battery subsystem defined in the FXM System in order to have this menu item available under **System Functions**.
2. From the **Configuration** table, set the **Termination Voltage** and **Timeout** values.
Which ever of these two conditions occurs first will terminate the battery test.
3. From the **Status** table, press the **Start Manual Battery Test** command.
To start a battery test, the **Battery Mode** must be in the **Float** mode, otherwise the battery test cannot start.
There are a number of reasons why the test might terminate early. Two examples are:
 - Detection of a weak battery - where the voltage drops too quickly.
 - AC failure.

If **Battery Runtime and Health Estimation** is enabled you should see the battery state of charge (SOC and runtime remaining (RTR, update during the test. If the test runs long enough, the test results should be stored in the **Battery Log** page.

The **Battery Runtime Remaining** algorithm attempts to calculate an accurate prediction of the remaining battery runtime. An accurate estimate of the battery health requires at least one discharge greater than 20% from when the unit is switched on.

When the unit is powered on, the algorithm assumes that a new battery is connected to the unit. Each discharge greater than 20% will result in a new calculation for the relative battery health. This value is used in the **Battery Runtime Prediction** algorithm to compensate for an aging battery. It is recommend the user set up a battery test with a depth of discharge of at least 20% every six months or so.

The **Battery Runtime Remaining** algorithm uses the battery voltage to predict the remaining runtime. Battery voltage changes rapidly during the first few minutes of discharge due to charging and discharging while the unit is in Inverter mode. This results in a less accurate predicted runtime. The battery voltage may change rapidly during the last 20% of the discharge when the battery is almost drained.

Schedule a Battery Test

To schedule a Battery Test:

1. Go to **System > FXM System > System Functions > Battery Test**.
2. From the **Automatic Testing** table, set the number of days between testing.
3. Set the start hours.
4. Set the number of days to wait before retrying to run a failed battery test.
5. Click on **Reschedule Next Time** to schedule the next battery test.

Run a Battery Test Remotely

To run a Battery Test remotely:

1. Go to **System > FXM System > System Functions > Battery Test**.
2. From the **Remote BT Configuration** table, set **Remote BT** to **Enabled**.
3. Select a user input to trigger the **Battery Test**.
4. When the **Trigger Input** is active and the conditions for the battery test are met, **Battery Test** will start to run.
Once **Remote BT** is triggered, **Battery Test** will continue to run even when the **Trigger Input** is no longer active.

9.3.10 Configure Battery Runtime and Health Estimation

The **Battery Runtime and Health Estimation** is used to calculate **Estimated State of Charge**, **Estimated Battery Health** and **Estimated Battery Runtime**. **Estimated Battery Health** is only updated when the battery is discharged below 80% state of charge.

To configure Battery Runtime and Health Estimation:

1. Go to **System > FXM System > System Functions > Battery Runtime and Health Estimation**.
2. From the **Configuration** table, enable **Battery Estimation**.
3. Set the **Load Model**. The load model has no affect on calculating **Estimated State of Charge** or **Estimated Battery Health**, but it has a significant impact on calculating the **Estimated Battery Runtime**.
 - a. With the constant current model, the load current is expected to stay the same as the load voltage decreases.
 - b. With the resistive model, the load current is expected to decrease as the load voltage decreases.
 - c. With the constant power model, the load current is expected to increase as the load voltage decreases.
4. Set the **Battery LVD**. Most FXM HP units do not have an external **Low Voltage Disconnect (LVD)**; if this is the case, this setting can be left unknown.

9.3.11 Configure AC Shutdown

The **AC Shutdown** function is used to turn off the AC output. With the inverter turned off, neither the inverter nor the AC line is supplying power to the load. The FXM will go to **Shutdown** mode. There are two ways to turn off AC output: manually or with a triggering source.

To turn off AC output manually:

1. Go to **System > FXM System > System Functions > AC Output**.
2. From the **Configuration** table, ensure that the **AC Output Shutdown Trigger State** is inactive.
3. Go to **System > FXM System > Configure System** and click on **AC Output Shutdown** command.
4. **Manual On:** The unit remains in shutdown mode. The output of the unit must be turned on manually by going to **System > FXM-HP > Configure System** and clicking on the **Start Up** command.
5. **Auto On After Delay:** After the unit is in shutdown mode, the unit will restart automatically after a delay.

To turn off AC output using a triggering source:

1. Go to **System > FXM System > System Functions > AC Output**.
2. From the **AC Shutdown** table, click on the details icon of **AC Shutdown Trigger Source** to select a triggering field.
3. Verify that value of **AC Shutdown Trigger State** is correct.
4. When the triggering field is active, the AC output will be turned off. FXM system goes to Shutdown mode.
5. When the triggering field is inactive, the output of the unit must be turned on manually by going to **System > FXM-HP > Configure System** and clicking on the **Start Up** command.
NOTE: AC output will be off due to shutdown. If the router is on, the output of FXM communication will be lost. To turn on output local access will be required.

9.3.12 Configure External Fan

The **External Fan** function is used to trigger a dry contact to control an external fan. When the battery temperature reaches the **Fan On Temperature** threshold, the assigned relay closes and turns on the external fan. Once the battery temperature drops below **Fan Off Temperature** threshold, the assigned relay opens, and turns off the fan.

To configure External Fan function:

1. Go to **System > FXM System > System Functions > External Fan**.
2. Assign a **Relay** that will be used to turn on the external fan.
3. Assign the **Temperature Sensor** that will be used to read the battery temperature.
4. In the status table, verify that the temperature is now reading a valid temperature value.
5. Set the **Fan On Temperature** threshold value.
6. Set the **Fan Off Hysteresis** value.
7. Verify the **Fan Off Temperature** threshold value is correct.

9.3.13 Configure Keep Alive

The **Keep Alive** function provides a method of restoring communication when a communication failure is detected. A reset temporarily removes power and resets the local communication equipment powered by this unit.

To configure the Keep Alive function:

1. Go to **System > FXM System > System Functions > Keep Alive**.
2. From the Status table, enable **Keep Alive Enable**.
3. From the Configuration table, configure the **Destination IP Address**.
4. If there is an active Keep Alive failure alarm, click on the **Reset Keep Alive Failure** button to clear the failure.

9.3.14 Configure Soft Shutdown

The **Soft Shutdown** function allows a third party software that is compatible with MegaTec protocol to monitor the status the FXM HP and shutdown the system during AC failure.

To configure the Soft Shutdown function:

1. Go to **Controller > Advanced Function > Soft Shutdown**.
2. In the Configuration table, set the **Soft Shutdown System** value.
3. Verify the Soft Shutdown State is Ready.
4. Connect a serial cable from the USB-Mini B connector to the computer running the third party software.

9.3.15 Configure SNMP UPS Management Information Base

The SNMP UPS Management Information Base (MIB) allows a 3rd party software to monitor the status the FXM HP and shutdown the system during AC failure over the SNMP network.

To configure UPS MIB System function:

1. Go to **Controller > Configure Controller > Communication > SNMP**
2. Set the **SNMP Agent** to Enabled.
3. In the Configuration table, set the **UPS MIB System** value.

9.3.16 Configure Relays

Contacts C1 to C5 allows the FXM HP to be connected to an external monitoring panel or traffic control equipment. For contact C6, the default factory configuration is +48 or +24 Vdc output.

The FXM HP unit has a list of predefined conditions that can energized a relay.

- On Battery – the battery is providing backup power to the load

- Low Battery 1 – the battery drops below a preset level
- Low battery 2 – the battery drops below a preset level
- Low Battery + No Line 1 – the battery drops below a preset level with no AC
- Low Battery + No Line 2 – the battery drops below a preset level with no AC
- Controller Minor Alarm – there is an active minor alarm
- Controller Major Alarm – there is an active major alarm
- Controller Critical Alarm – there is an active critical alarm
- Low Battery Shutdown – the battery voltage drops below the Inverter Shutdown Voltage, the inverter will shut down and go to Standby mode

On Battery

To configure the relay activated by **On Battery** status on the LCD:

1. Go to the **System Shortcuts** menu and select **Relays**.
2. On the **Relays** page, select **Configuration**.
3. Click the edit icon of **On Battery** and select a relay to be energized when the **On Battery** status is active.

To configure the relay activated by **On Battery** status on the web:

1. Go to **System > FXM System > Configuration > Alarms** page.
2. Click on the **On Battery** detail icon.
3. Click on the **On Battery Relay** edit icon to select a relay.

Low Battery and Low Battery + No Line

To configure the relay activated by **Low Battery** status or **Low Battery + No Line** status on the LCD:

1. Go to the **System Shortcuts** menu and select **Relays**.
2. On the **Relays** page, select **Configuration**.
3. Click the edit icon of **Low Battery 1** and select a relay to be energized when the **Low Battery** status is active.
4. Click on **Low Battery 2**, **Low Battery + No Line 1** or **Low Battery + No Line 2** to select a relay to be energized for the corresponding status.

To configure the relay activated by **Low Battery** status on the web:

1. Go to **System > FXM System > Configuration > Alarms** page.
2. Click on the **Low Battery Warning 1** detail icon.
3. Click on **Low Battery Warning 2**, **Low Battery + No Line 1** or **Low Battery + No Line 2** to select a relay to be energized for the corresponding status.

Controller Minor, Major or Critical Alarm

To configure the relay activated by **Controller Minor Alarm**, **Major Alarm**, or **Critical Alarm Status** on the LCD:

1. Go to the **System Shortcuts** menu and select **Relays**.
2. On the **Relays** page, select **Configuration**.
3. Click the edit icon of **Controller Minor Alarm** and select a relay to be energized when the **Controller Minor Alarm** status is active.
4. Click on **Controller Major Alarm** or **Controller Critical Alarm** to select a relay to be energized for the corresponding status.

To configure the relay activated by **Controller Minor Alarm**, **Major Alarm**, or **Critical Alarm Status** on the web:

1. Go to **Controller > Configure Controller > Alarm and Alarm Summary Relays** page.
2. Click on the **Controller Critical Relay** edit icon to select a relay.
3. Click on **Controller Major Relay** or **Controller Minor Relay** to select a relay to be energized for the corresponding status.

Low Battery Shutdown

To configure the relay activated by **Low Battery Shutdown Status** on the LCD:

1. Go to the **System Shortcuts** menu and select **Relays**.
2. On the **Relays** page, select **Configuration**.
3. Click the edit icon of **Low Battery Shutdown** and select a relay to be energized when the **Low Battery Shutdown** status is active.

To configure the relay activated by **Low Battery Shutdown Status** on the web:

1. Go to **System > FXM System > Configuration > Alarms** page.
2. Click on the **Low Battery Voltage Shutdown** detail icon.
3. Click on **Low Battery Voltage Shutdown Relay** edit icon to select a relay.

9.3.17 Configure Power Outage Alarm

Frequent short power outages can generate a lot of unnecessary alarms and email notifications.

The **Power Outage Alarm** function can be configured to ignore short power outage and trigger only when the outage is longer than a user defined duration. Similarly, **On Battery** alarm is triggered only when the power outage is longer than the minimum power outage duration.

To configure the minimum power outage duration

1. Go to **System > Configure System**.
2. From the System Properties table, configure **Ignore Outage Shorter Than**.

Short power outage will not trigger the alarms, but they will be logged in the Power Outage log.

10 Maintaining the Controller

When maintaining your controller always check for known issues within the readme file that ships with your software. This section of the manual covers the following:

- Ethernet communications
- Working with alarms
- Controller maintenance
- Working with logs
- User account maintenance
- File maintenance

10.1 Ethernet Communications

By default, Ethernet port 1 on the controller is configured to acquire an IP address automatically, and the Ethernet port 2 is configured to use a static IP address of 192.168.0.90. The LCD can be used to view and configure the IP addresses that are being used on both Ethernet ports.

To view or configure the IP addresses:

-
1. From the LCD main dashboard click **Shortcut**, and then press **Ethernet**.
 2. The LCD displays the IP address currently used on both Ethernet ports.
 3. Click to highlight the row of the port you want to view or configure.
 4. Press the arrow on the right-side of the screen and then LCD displays the menus: **Status, IPv4 Address, IPv6 Addresses** and **Configuration**.

To change the IP address settings:

5. Select the **Configuration** menu to highlight, then press the arrow on the right-side of the screen to enter.
6. Select **Change Network Configuration** to highlight that row, and then click the arrow on the right-side of the screen to start the wizard.
7. Enter the desired IPv4 settings using the **Previous**, **Next** and **Cancel** buttons.
If you are configuring a manual IPv4 address, you must supply all four values: address, subnet, gateway and DNS server. If you do not know the DNS server address, you can set it to 0.0.0.0. If you do not have a gateway address, it is common to substitute the number 1 for the last entry. So, if your IP address is 192.168.0.90, then you can set your gateway to 192.168.0.2.
8. When complete, click **Finish** and the changes are applied.
9. Click the back arrow, on the upper-left side of the screen twice and go back to the **Ethernet** screen to confirm the new settings.

On the Ethernet screen, verify that the new IP address settings are in use.

10.1.1 Connecting via the Web

By default, the rear Ethernet port of the controller is configured to acquire an IP address automatically and the front Ethernet port is configured to use a static IP address of 192.168.0.90.

To configure the IP addresses via the web:

1. From the main dashboard, go to **Controller > Configure Controller > Communications > Ethernet**.
2. In the **Ethernet** table, click the more details icon on the row you want to configure.
3. In the **Configuration** table, click **Change Network Configuration** and follow the steps in the wizard.

From the **Ethernet** table, view and verify the new IP address settings.

NOTE: If you change the IP address that you are using, you will need to type the new IP address into your browser so that you can log in again.

10.2 Working with Alarms

10.2.1 Active Alarms

When there are active alarms in the system, both the LCD and Web interface display these alarms prominently.

Depending on how the alarms are configured, an internal speaker (if present and installed) may sound an alarm tone, and one or more relays may be activated. The internal speaker is intended to give the on-site technician audible notification that an alarm is active. The relays are intended to give external monitoring equipment notification through a relay contact closure (or opening) that an alarm is active.

On both the web interface and the LCD screen, the top left region of the page displays the most recent alarms in order of the highest priority. This area of the display will be red when there are critical or major alarms, yellow for minor alarms, and green if there are only warnings or no alarms. Clicking this region takes you to the **Active Alarms** table where you can get more details.

The **Active Alarms** table displays the name of the alarm, time of activation, priority and status. The status of an active alarm can be active or acknowledged. An alarm moves from the active to the acknowledged state when the alarm cut-off (ALCO) button is pressed. The ALCO button is at the top of the **Active Alarms** table.

On the Web interface there is also a small ALCO button in the **Active Alarms** region of the main dashboard that will acknowledge any active alarms, and then take you to the **Active Alarms** list.

On the LCD screen, ALCO can also be accessed via the **Maintenance** button on the main dashboard.

To view details of an active alarm click the more details icon on the right-side of the row in the **Active Alarms** table. This screen shows you the state of the alarm, time of activation, time of acknowledgment, priority and the relay that is mapped to the alarm. To get troubleshooting information about the alarm, press the information icon beside the row that shows the alarm state.

10.2.2 Alarm Cut-off

The Alarm Cut-Off (ALCO) button is used to silence the speaker (if installed) while technicians are investigating and troubleshooting an active alarm. ALCO can also be configured to deactivate alarm relays.

ALCO functionality is configured via **Alarms > Alarm Cut-off Settings and Global Alarm Settings**.

ALCO can be configured to either:

- Acknowledge active alarms, deactivate relays, and silence speaker
- Or silence the speaker only

When ALCO is pressed, the user configured ALCO period begins to countdown. When the count down reaches zero the ALCO period expires.

When ALCO expires the configured action is canceled. If you configured ALCO to acknowledge active alarms, deactivate relays, and silence speaker then alarms return to the active state which means the alarm relays are activated and the speaker begins sounding. If you configured ALCO to silence the speaker only, the speaker will start sounding as long as there are active alarms.

If a new alarm activates after ALCO is pressed, the speaker will sound the appropriate alarm tone. Any existing alarms that have been acknowledged from a previous ALCO press will remain acknowledged.

10.2.3 Alarm Activation Delay at Startup

Depending on system configuration there may be some alarms that activate shortly after startup then clear a few seconds later. These nuisance alarms are often caused due to the time it takes for the controller to re-acquire modules on the CAN bus. To prevent these alarms from activating and triggers relays or SNMP traps there is a setting that delays alarm activation at startup.

The alarm delay is configured under **Alarms > Alarm Cut-off and Global Alarm Settings**.

The default value of 30s works for most systems, however this value can be increased to accommodate systems that have a slower start up time, i.e. large inverter systems.

10.2.4 Alarm Summary Relays

There are three alarm summary relays that can be configured on the controller. These relays are connected to external monitoring equipment which provides a notification when the controller enters an alarm state.

- Controller Critical Relay
- Controller Major Relay
- Controller Minor Relay

To view them go to **Controller > Configure Controller > Alarms and Alarm Summary Relay**.

The relay mapped to the **Controller Critical Relay** is active whenever one or more critical alarms are active. Both **Controller Major Relay** and the **Controller Minor Relay** work in the same way.

FXM HP Alarms

The following tables describes the configurable alarms.

Alarm	Priority	Alarm Description
AC Input Back Feed Failure	Critical	AC input relay did not open when the inverter started.
AC Input Breaker Open	Warning	AC input breaker is open.
AC Input Frequency High	Warning	AC input frequency is below the specified limit.
AC Input Frequency Low	Warning	AC input frequency is above the specified limit.
AC Output is Overloaded	Critical	The load is drawing more than the rated power.
AC Output Short Circuit	Critical	AC output is shorted.
AC Output Voltage High	Major	AC output voltage is above the specified limit.
AC Output Voltage Low	Major	AC output voltage is below the specified limit.
AC Power Outage	Warning	AC power failed.
Battery Breaker Open	Warning	Battery breaker is open.
Battery Fail Fault	Critical	Battery appears to have high impedance and has failed.
Battery Over Voltage	Critical	Battery Voltage is too high
Battery Temperature Probe Unplugged	Minor	The temperature probe is unplugged or has failed.
Bypass Mode On	Minor	The unit is in Bypass mode.
Close to Inverter Shutdown	Major	Battery voltage is low, and the inverter is about to shut down.
Fan Fail	Warning	The unit's fan has failed.
Frequency Unknown	Critical	The unit is unable to detect AC frequency.
Internal Temperature	Major	The unit's internal temperature is too high.
Keep Alive Failure	Major	Keep Alive is unable to communicate with host.
Low Battery and No Line 1 & 2	Major	The battery capacity is below the Low Battery Threshold and AC is not available.
Low Battery Voltage Shutdown	Critical	Battery voltage is below Inverter Shutdown Voltage and the unit goes to Standby mode.
Low Battery Warning 1	Major	The battery capacity is below the Low Battery Threshold.

Alarm	Priority	Alarm Description
Low Battery Warning 2	Major	The battery capacity is below the Low Battery Threshold.
Missing FXM	Critical	The FXM hardware module is missing.
On Battery	Warning	The battery is providing power to the load.

10.2.5 Creating User Alarms

The controller has a set of default standard alarms that are associated with a system or an inventory item such as a load or a disconnect. These standard alarms may be enough to support many system configurations. It is also common to need additional alarms, based on the status of the digital inputs or on the threshold of an analog value read from the input of an ADIO device.

You can create any number of digital or threshold alarms. These alarms have the same behavior as standard alarms such as alarm cut-off, SNMP traps, and relay mapping. These user-defined alarms can be created and removed via the **Controller > Advanced Functions > User Alarms** menu.

To create a user alarm:

-
1. Go to **Controller > Advanced Functions > User Alarms**.
 2. Select the type of user alarm to create. A new row for the user alarm will display in the table.
 - If you want to create a digital alarm click the **Add Digital User Alarm** button.
 - If you want to create a high or low threshold alarm click the **Add Threshold User Alarm** button.
 3. Click the details icon. Two tables display. One table shows the fields to configure that are specific to the selected user alarm. The other table shows the standard alarm configuration.
 4. Give the alarm a descriptive name. This is important since the same type of user alarms have the same default name. The alarm description is optional.
 5. Select the alarm input source. There are different options depending on the type of user alarm you are creating.
 - A threshold alarm allows you select from ADIO voltage and temperature inputs, current readings from shunts or DCCTs and any status count data about rectifiers or converters.
 - A digital alarm allows you to select digital inputs on any ADIO devices.
 6. Set the priority and relay. If you want to set a severity value for the SNMP trap, use the Parameter 1 field.
 7. If you are configuring a digital alarm, this is all that is required. If you are configuring a threshold alarm, continue as described below.

8. Select the type of threshold alarm from the Alarm When Value field.
 - Selecting Above turns this alarm into a high threshold alarm.
 - Selecting Below turns this alarm into a low threshold alarm.
9. Set the threshold. For a high threshold alarm to activate, the source value must be greater than this value. For a low threshold alarm to activate, the source value must be less than this value.
10. Set the hysteresis. The hysteresis is important when using an alarm input source that may be noisy or fluctuate periodically. Be sure to set the hysteresis large enough to avoid false alarms, but not too large to prevent the alarm from clearing properly.

The new alarm has been configured. Whenever possible, test to ensure that new alarm operates as expected.

10.3 Controller Maintenance

This section of the manual covers the following:

- Resetting the controller
- Powering down the controller
- Changing the date and time
- Changing the controller language
- Changing user interface strings

10.3.1 Resetting the Controller

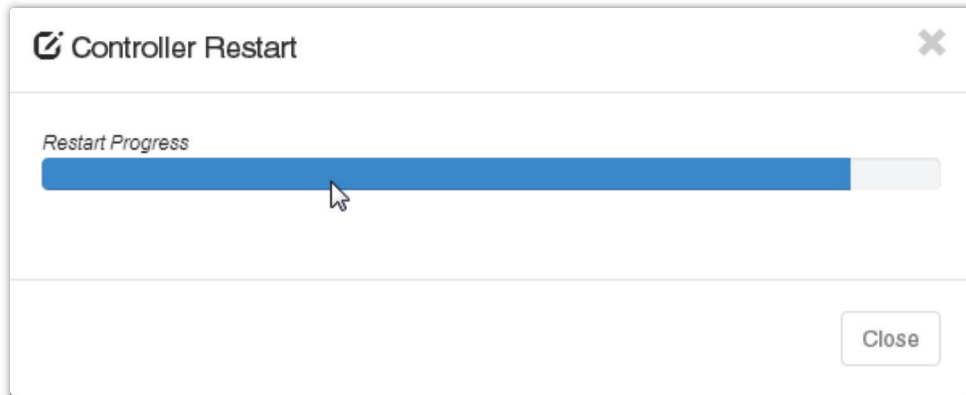
You can perform a reset via the web or the LCD screen of the controller. This first procedure covers resetting from the web.

CAUTION: *Ensure that a backup has been performed before starting this process. Use the Backup feature accessed through the LCD at **Shortcuts > Backup**.*

CAUTION: *Ensure that the controller software or operating system software is not being updated.*

From the web do the following:

-
1. From the main dashboard go to **Controller > Controller Status**.
 2. Click the **Reset Controller** Button.
 3. The **Controller Restart** window displays progress via a blue bar.



4. The controller screen goes black, and the LEDs lights cycle while restart is in progress.

Once complete, the Login page displays on the web, and the Cordex™ HP logo displays on the controller.

10.3.2 Resetting via the LCD

CAUTION: Ensure that the controller software or operating system software is not being updated.

To reset the controller via the LCD:

-
1. From the main dashboard of the controller, click **Shortcuts**, then click **Reset**.
 2. Click the **Execute** button to confirm.

The front screen blacks out, and the LED status lights cycle until the reset is complete. Once the reset completes, the Cordex™ HP logo displays.

10.3.3 Changing the Time and Date

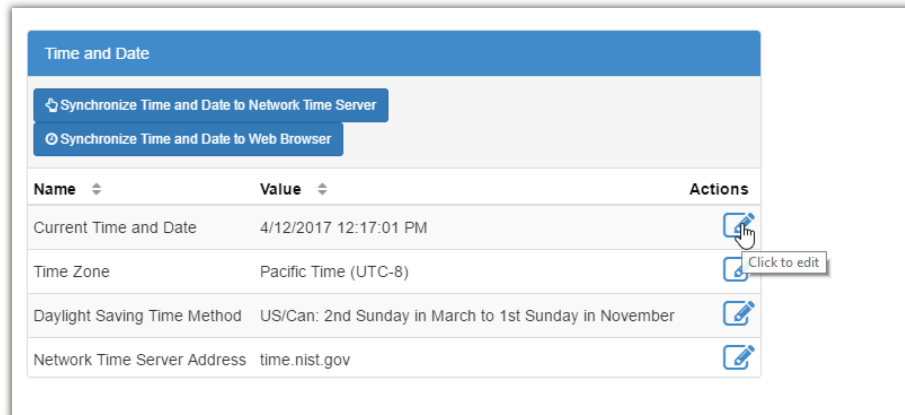
There are three options to change the date and time:

- manually with the date/time picker
- using the local browser/computer
- using simple network time protocol (SNTP)

To set the date and time:

-
1. Go to **Controller > Configure Controller > Time and Date**.
 2. From the drop-down **Time Zone** menu, select your time zone, and then click **Save**.

3. If setting the time manually, click the edit icon beside the **Current Time and Date**. Use the date/time picker to change the date and time.
4. If setting the time and date with the local browser click **Synchronize Time and Date to Web Browser**. This reads the time from the browser and sends it to the controller.



5. If setting the time and date using SNTP, first enter a valid SNTP server address, and then click **Synchronize Time and Date to Network Time Server**. If you do not want to use the SNTP server, clear the **Network Time Server Address** field.
It is common for gateways and routers to also be SNTP servers. If you are unsure of a valid SNTP server address, try using the controller's assigned gateway/router address. If this does not work, consult your IT personnel.

The controller time and time zone have been correctly set.

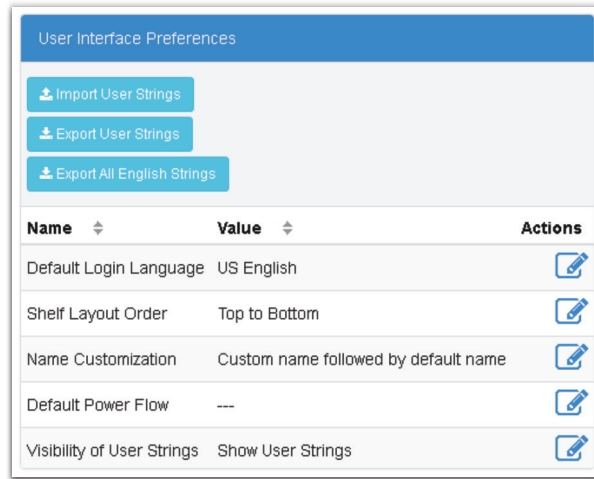
NOTE: Whenever the time or time zone has been changed, an entry is recorded in the event log.

10.3.4 Changing the Default Login Language

Changing the default login language affects the language displayed on both the LCD and the web.

To change the default login language from the web do the following:

1. Go to **Controller > Configure Controller > User Interface Preferences**.
2. In the **User Interface Preferences** table, find the **Default Login Language** row and click the edit icon.



3. From the drop-down menu, select your language preference, and then click **Save**.

10.3.5 Changing User Interface Strings

In rare occasions it may be desired to change some of the strings displayed on the user interface to conform to local terminology standards. The controller allows a user to download a strings file that can be edited in a spreadsheet program. The strings file can then be uploaded to the controller and after a restart, the changed strings will be used. **NOTE: Use of this feature must be approached with caution as it may result in undesired consequences:**

- Editing the strings requires familiarity with a spreadsheet program in order to correctly import the file and save the file with UTF-8 encoding.
- Edited strings that are longer than the original can distort the user interface and make navigation difficult.
- Spelling or grammar errors can make the user interface hard to understand.
- Uploading an incorrectly generated strings file can result in unexpected or missing strings that make the interface unusable.
- The changed strings can result in confusion when seeking technical support since the user interface may be unfamiliar to support personnel.
- Strings on the OLED display cannot be changed.

To change one or more strings on the user interface do the following:

1. Go to **Controller > Configure Controller > User Interface Preferences**.
2. In the **User Interface Preferences** table, click the **Export All English Strings** button. The file will be downloaded to the PC (when using the WEB UI) or to a USB drive (when using the LCD UI). It is also possible to only export previously uploaded user strings by clicking the **Export User Strings** button.
3. Import the file as a UTF-8 encoded CSV file to a spreadsheet program. Failure to do this may result in missing or unexpected strings.
4. Make the necessary edits to the strings in the second column. Do not change anything in column 1 or strings may not be imported as expected.
5. Save the file as a UTF-8 encoded CSV file. Failure to do this may result in missing or unexpected strings.
6. Press the **Import User Strings** button and select your strings file. If using the LCD UI, the uploaded filename must contain the word “strings” and end in “.csv”.
7. Restart the controller to load the new strings.
8. On startup, the new strings will be loaded. Any errors found while loading the new strings will be logged into the event log.

When interacting with technical support, you may be requested to hide the user strings from the user interface. To do this go to **Controller > Configure Controller > User Interface Preferences** and change the **Visibility of User Strings** setting to **Hide User Strings**. Restart the controller. The strings can be shown again by changing the setting to **Show User Strings** and restarting the controller.

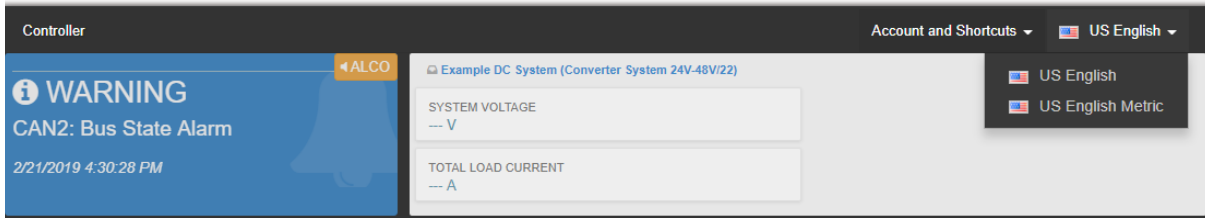
10.3.6 Changing the Web Session Language

To support situations where users want different language options, you can change the language used for a specific login session. Most corporate security policies ban the storage of browser cookies, which means that the browser will not remember your selection from login to login so you need to select your web session language each time you login.

NOTE: *Without cookie support, if you force a refresh (F5 for most browsers, the browser will not remember the language selection and you will need to change the web session language again.*

To change the web session language do the following:

1. Go to the top right corner of the web page.



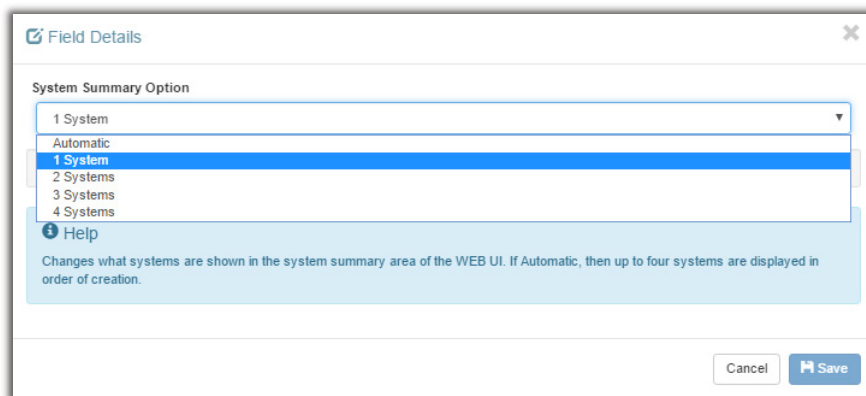
2. From the Account and Shortcuts drop-down menu, select your language preference.

10.3.7 Changing the System Status Bar

By default, the controller dashboard displays your systems in the original order created, from left to right. The **System Summary Option** is **Automatic** by default but can be customized to display up to four systems slotted in any order required. This is done via the **System Summary Option**, in the **Web Server Preferences** table.

To customize the system status bar view:

1. Go to **Controller > Configure Controller > User Interface Preferences**.
2. In the **Web Server Preferences** table, select **System Summary Option**.
3. From the **System Summary Option** drop down menu, select how many systems to display, and then click **Save**.



- To change which system displays in the left most area of the system status bar, click edit for 1st system, and then select an option from the drop-down menu.

Web Server Preferences		
Name	Value	Actions
System Summary Option	1 System	
1st System	DC System 48V/4064	
2nd System	---	
3rd System	---	
4th System	---	

- Continue to assign systems to the 2nd, 3rd, and 4th slots as required.

The system status bar displays the selected systems in the order selected.

10.3.8 Changing the Dashboard Values

It is possible to change the values that show for a system on the **System Status Bar**, the **LCD Dashboard**, and the **Web UI Dashboard**.

To change which values appear for a system:

-
- Go to **Controller > User Interface Preferences**.
 - Look at the table for the system you wish to configure (for example, DC System 48V Dashboard Values).
 - Click the edit icon beside the **Dashboard Value** you would like to edit.

NOTE: The values in this table will appear on the different dashboards in the order they appear in this table (for example, **Dashboard Value 1**, then **Dashboard Value 2**, etc.). To change the order, set the fields in this table in the desired order.

- Select the value to show for this **Dashboard Value**, then click **Save**.

The new value selected will appear in the position of the **Dashboard Value** that was configured.

10.3.9 Data Sharing

The Data Sharing feature allows some data to be shared between controllers. This data sharing feature consists of two parts:

- Published Data
- Data Subscriptions

Data sharing can be useful in situations where systems were installed at different times. These systems may have different controllers, but share the same bus (for example, a DC System was installed, then later-on, an AMPS System was installed, each with their own controllers).

Using this feature, the AMPS System controller provides the DC System controller with data on how much DC Input Current it will require during an outage.

The DC System controller provides the AMPS System controller with data on how much runtime the battery has remaining.

Published Data

Each controller can publish ten data points, which other controllers can read and use for various purposes. Currently, these data points are limited to numeric data.

To configure which data points should be shared with other controllers:

1. Go to **Controller > Configure Controller > Communications > Data Sharing > Published Data**.
2. Click the edit icon next to one of the **Published Data** values.
3. Select the data point to be shared with other controllers, then click **Save**.
4. This process can be repeated to share multiple data points with other controllers.

After performing the above procedure, other controllers will be able to subscribe to this controller to receive data from it.

Data Subscriptions

Data Subscriptions are a way for users to read and use **Published Data** from other controllers.

To configure a **Data Subscription**:

1. Go to **Controller > Configure Controller > Communications > Data Sharing > Data Subscriptions**.
2. Click **Add Data Subscription**.
3. Click the more details icon to go into the details of this newly created **Data Subscription**.
4. Click the edit icon beside **IP Address**, enter in the IP address of the controller to read data from, then click **Save**.

After configuration, the **Data Subscription** will start reading any configured **Published Data** from the remote controller. Data will be read and updated every ten seconds.

If there are any problems communicating with the remote controller, those will be indicated in **Communication Status**, potentially being raised as an alarm through the **Communication Error** alarm. Some common errors could be:

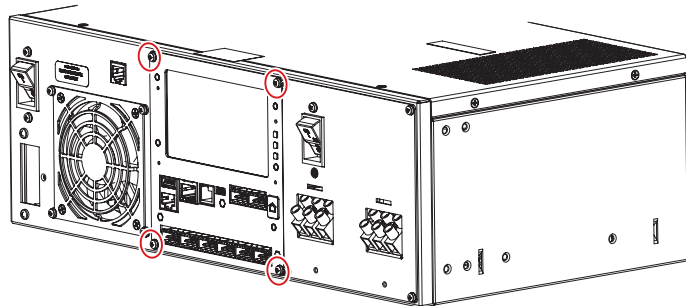
- IP address configured incorrectly

- The controller or the remote controller are not connected to any network, not connected to the same network, or not publicly visible
- No published data configured on the remote controller (this will be indicated as a **No Published Data** status)

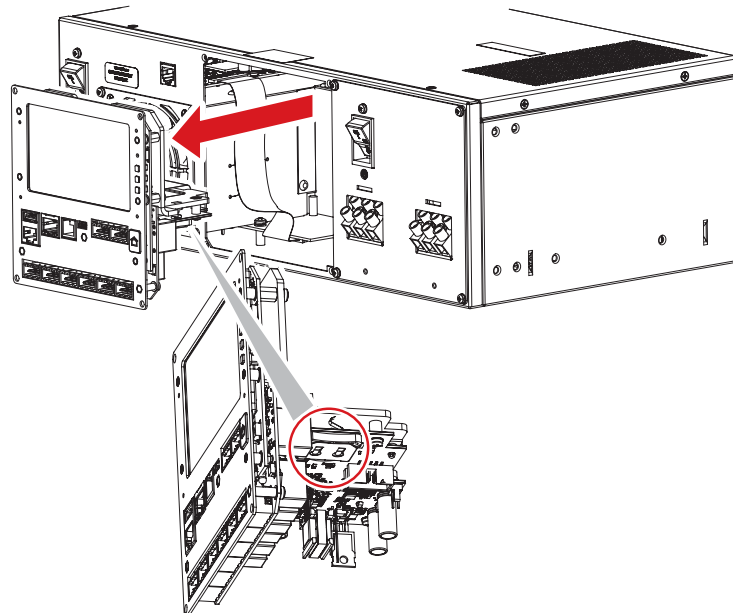
10.3.10 Replacing the Controller Battery

To replace the controller battery:

1. Shut down the unit.
2. Remove the four screws holding the control panel to the unit.

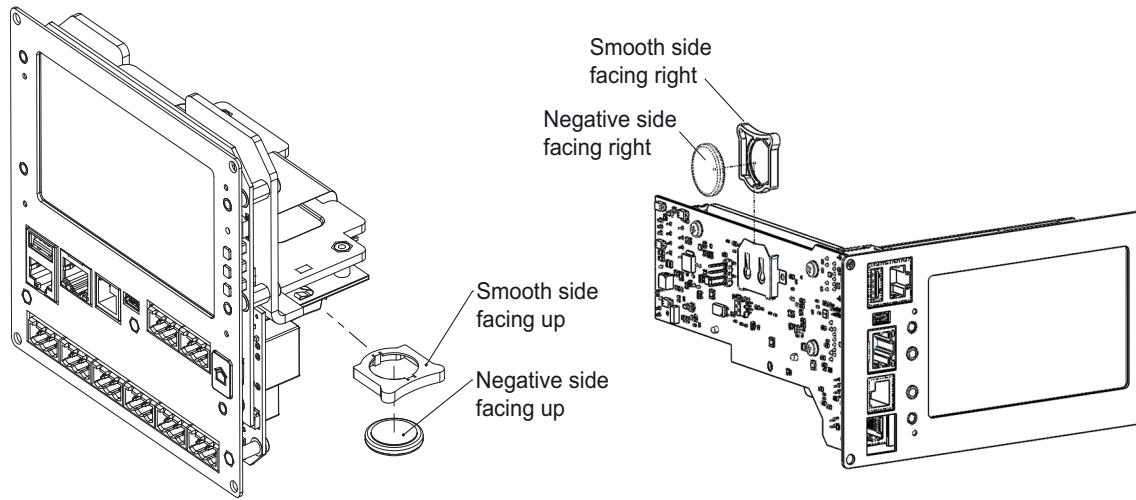


3. Gently pull the control panel sub-assembly out of the unit. Look for the battery and battery holder on the inside of the control panel assembly.



CAUTION: Use care not to stretch the wires or the ribbon cables attached to the back of the unit.

- Pull out the battery holder. Remove the battery from the holder. With the new battery, note the polarity of the battery and orientation of the holder when reassembling it back to the unit.



FXM HP 1100/2000

FXM HP 650

- Carefully reinstall the control panel. Smooth out the wires and cables so they do not get caught or pinched.
- Replace the four screws.

10.4 Working with Logs

This section of the manual covers the following:

- Events and Alerts Log
- Battery Log
- Power Outage Log
- Datalogs
- Performance Log

10.4.1 Event and Alert Logs

Figure 57: Events and Alerts Log

Events						Module Alerts					
Time	Source	Name	Value	Actions		Time	Source	Name	Value	Actions	
11/3/2016 11:16:58 AM	Web User	Logon	admin			11/3/2016 9:31:14 AM	T2S Inverter Controller/2432	CAN Communication Status	Now: Normal		
11/3/2016 11:15:39 AM	Web User	Logon	admin			11/3/2016 9:30:43 AM	314100240	Mode	Now: Supplying Power		
11/3/2016 10:53:37 AM	DC System 48V/3696	AC Mains Voltage Low	Active			11/3/2016 9:30:43 AM	L-ADIC/376000226	CAN Communication Status	Now: Normal		
11/3/2016 9:31:18 AM	DC System 48V/3696	System Mode	Now: Battery Conditioning			11/3/2016 9:30:43 AM	314100240	CAN Communication Status	Now: Normal		
11/3/2016 9:31:18 AM	DC System 48V/3696	Battery Conditioning	Now: Float			11/2/2016 4:16:08 PM	T2S Inverter Controller/2432	CAN Communication Status	Now: Normal		
11/3/2016 9:31:03 AM	Inverter System/3686	Inverter Comms Lost	Inactive			11/2/2016 4:15:38 PM	314100240	Mode	Now: Supplying Power		
11/3/2016 9:31:03 AM	Inverter System/3686	T2S Comms Lost	Inactive			11/2/2016 4:15:38 PM	L-ADIC/376000226	CAN Communication Status	Now: Normal		
11/3/2016 9:30:59 AM	Controller	Temporary License In Use	Inactive			11/2/2016 4:15:38 PM	314100240	CAN Communication Status	Now: Normal		
11/3/2016 9:30:57 AM	Inverter System/3686	System Mode	Now: Unlicensed - Disabled			11/2/2016 11:04:36 AM	314100240	Mode	Now: Supplying Power		
11/3/2016 9:30:53 AM	Command	Disable Temporary License				11/2/2016 11:04:34 AM	314100240	Ramp Test Fail / No Output Power	Now: Inactive		

Events

The **Event** log table keeps a record of changes to the state of the system to help with troubleshooting. The types of state changes that are logged include:

- Alarm states
- Configuration changes
- Battery Mode changes (for example, discharging)

To view the **Event** log, go to **Logs > Events and Alerts**.

Events are stored in a 'first in first out' (FIFO) buffer holds up to 3000 events. Of the most recent events, up to 25 can be viewed on the LCD, and up to 300 can be viewed via the web. From the web interface, all 3000 events can be exported as a .csv file.

To export an Event log go to **Logs > Events and Alerts**, and press the **Export** button at the top of the **Event** table.

Module Alerts

The **Modules Alerts** log table tracks what is happening on individual modules without interfering with **Alarms** or the **Event** log.

10.4.2 Battery Log

The **Battery** log records the duration and change in capacity (A-h) for every charge and discharge of a battery. If you have **Battery Runtime and Health** enabled, the log will also record the change in **State of Charge** (SOC) and **State of Health** (SOH).

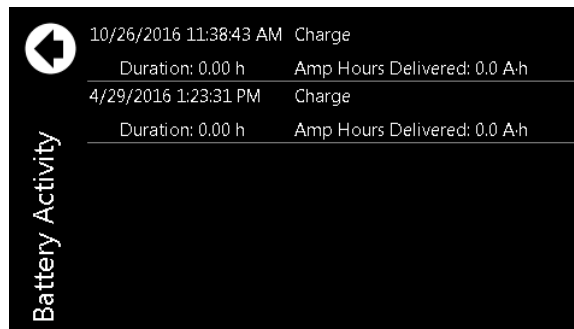
Because of the large quantity of information that can be collected for battery charges and discharges, a complete dataset can only be obtained by exporting the log. The following three figures provide examples of the data.

When viewed on the LCD, the log shows time, activity type, duration and amp hours delivered.

When viewed on the web, the log includes the battery ID, battery capacity, state of charge, state of health and the activity results.

When exported to a .csv file, the log includes the Peukert exponent, starting and ending voltages plus the minimum, maximum and average battery currents and temperatures.

Figure 58: Battery Log on the LCD



	Time	Activity	Duration	Amp Hours Delivered
Battery Activity	10/26/2016 11:38:43 AM	Charge	0.00 h	0.0 A.h
	4/29/2016 1:23:31 PM	Charge	0.00 h	0.0 A.h

Figure 59: Battery Log on the Web

Battery Identifier	Battery Activity	Start Time	Duration (h)	Battery Capacity (A-h)	Amp Hours Delivered (A-h)	Change in SOC (%)	Starting SOH (%)	Change in SOH (%)	Battery Current - Avg (A)	Activity Results	Actions
Battery String/7887	Charge	11/2/2016 12:18:50 PM	1.58	42.0	8.6	20.7	84.2	---	5.4	Normal	
Battery String/7887	Discharge	11/2/2016 11:58:06 AM	0.34	42.0	-9.4	-26.5	85.0	-0.8	-27.2	Normal	
Battery String/7887	Charge	11/2/2016 11:54:34 AM	0.02	42.0	0.1	0.3	85.0	---	4.8	Normal	
Battery String/7887	Discharge	11/2/2016 11:54:14 AM	0.00	42.0	-0.1	-0.4	85.0	---	-34.8	Normal	
Battery String/7887	Charge	11/1/2016 1:25:10 PM	0.00	42.0	0.0	---	85.0	---	1.4	Normal	
Battery String/7887	Charge	11/1/2016 11:12:33 AM	1.86	42.0	12.2	---	85.0	---	6.5	Normal	
Battery String/7887	Discharge	11/1/2016 11:12:16 AM	0.00	42.0	-0.2	---	85.0	---	-72.0	Normal	
Battery String/7887	Charge	11/1/2016 11:10:25 AM	0.03	42.0	0.3	---	85.0	---	10.2	Interrupted by Discharge	
Battery String/7887	Discharge	11/1/2016 11:10:16 AM	0.00	42.0	0.0	---	85.0	---	0.0	Normal	
Battery String/7887	Charge	11/1/2016 11:09:28 AM	0.01	42.0	0.2	---	85.0	---	16.2	Interrupted by Discharge	

Figure 60: Battery Log in Excel

Battery Identifier	Battery Activity	Start Time	Duration (h)	Battery Estimation	Battery Capacity (A-h)	Amp Hours Delivered (A-h)	Starting Voltage (V)	Ending Voltage (V)	Starting SOC (%)	Change in SOC (%)	Starting SOH (%)	Change in SOH (%)	Peak Current (A)	Battery Current - Min (A)	Battery Current - Avg (A)	Battery Current - Max (A)	Battery Temperature - Min (°C)	Battery Temperature - Avg (°C)	Battery Temperature - Max (°C)	Activity Results
Battery String/7887	Charge	11/2/2016 12:18	1.58	Enabled	42	8.6	26.7	27	73.5	20.7	84.2	---	1	1.2	5.4	37.9	25	26	26	Normal
Battery String/7887	Discharge	11/2/2016 11:58	0.34	Enabled	42	-9.4	27	24.2	100	-26.5	85	-0.8	1	-27	-27.2	-28.4	25	25	26	Normal

10.4.3 Power Outage Log

The **Power Outage** log records time and duration of every power outage to the system. If you have **Battery Runtime and Health** enabled, you can refer to the Battery log to determine the change in **State of Charge (SOC)** and **State of Health (SOH)**.

When viewed on the LCD, the log shows start time, end time, and time and duration of each power outage.

When viewed on the web, the log includes the system ID, start time, end time and duration of each power outage.

When exported to a .csv file, the log includes the system ID, start time, end time and duration of each power outage.

10.4.4 Datalogs

Datalogs allows users to record measurements (**Data Signals**) at set intervals over a period of time. The **Datalog** uses the CXC HP sensors and calculated values as inputs. The controller supports up to 10 **Datalogs**, each of which may be recording up to 20 **Data Signals**.

Figure 61: Datalogs Table

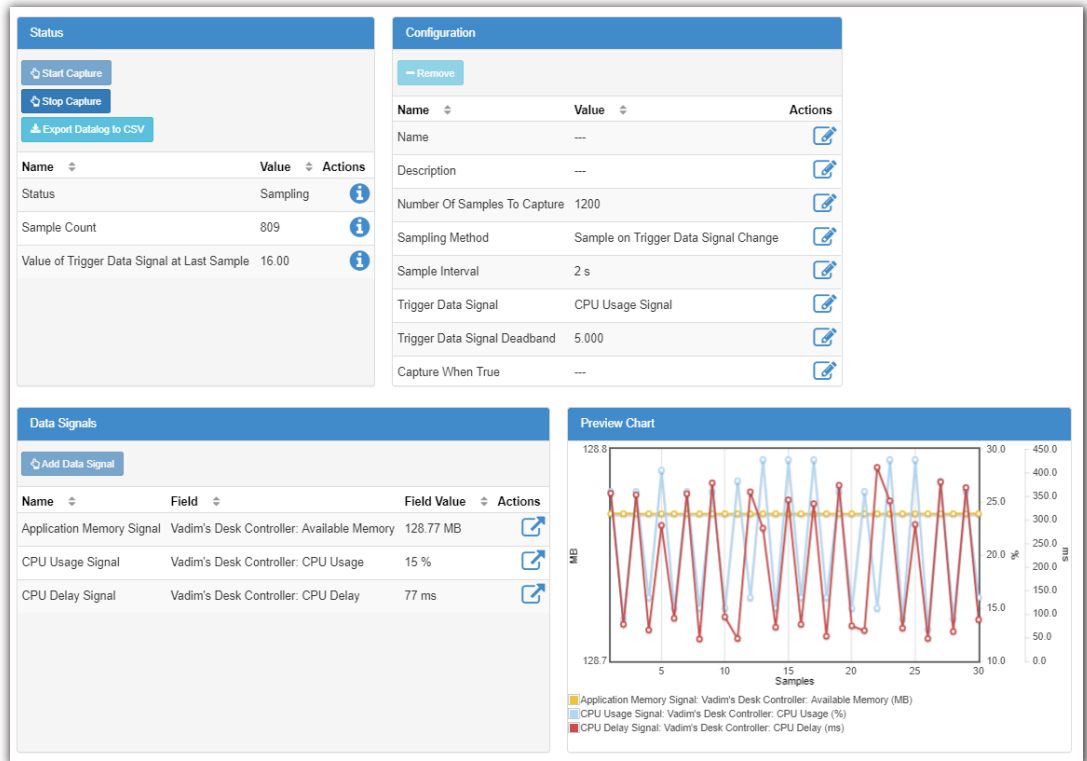
Name	Status	Sample Count	Actions
Battery Datalog (Datalog/5092)	Waiting	602	Remove Refresh
Temperatures (Datalog/1280)	Sampling	297	Remove Refresh

The interval between samples can be configured, as well as the number of samples collected. When the maximum number of samples have been collected, the newest sample replaces the oldest sample.

Data capture can either be started and run continuously or an equation can be used to control data capture.

Datalogs are saved to the file system when the controller is reset by a user, as well as being automatically saved once every day. If power is lost to the controller, there is potential for some data loss.

Figure 62: Datalog Window: Status, Signals, Configuration and Preview Chart



If any **Data Signals** are not configured, a **Datalog** will not start.

If there is a **Clock Error Alarm**—which means that the date has not been set, a **Datalog** will not start.

If a **Datalog** is running and a controller reset occurs, the **Datalog** will try to resume data collection on controller startup.

If there is data available, a **Preview Chart** displays up to 30 samples. If there are more than five **Data Signals**, only the first five signals are displayed in the preview. If a value is unknown, it is displayed on the preview as a zero value.

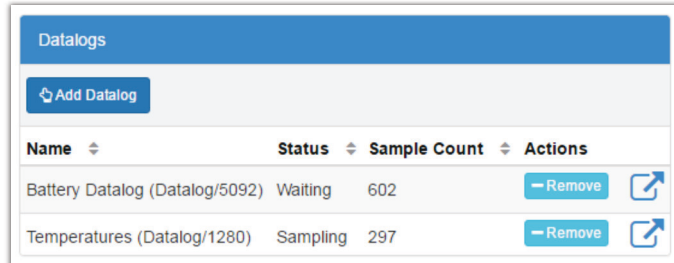
Create a Datalog

There are three stages to setting up a **Datalog**:

- Add a **Datalog**
- Add the **Data Signals**
- Run the **Start Capture** command

To create a **Datalog**:

1. Go to **Logs > Datalogs** and click **Add Datalog**.



Up to 10 datalogs can be created.

2. Click the more details icon of the new **Datalog**.

Status

- Start Capture
- Stop Capture
- Export Datalog to CSV

Name	Value	Actions
Status	Sampling	i
Sample Count	809	i
Value of Trigger Data Signal at Last Sample	16.00	i

Configuration

- Remove

Name	Value	Actions
Name	---	edit
Description	---	edit
Number Of Samples To Capture	1200	edit
Sampling Method	Sample on Trigger Data Signal Change	edit
Sample Interval	2 s	edit
Trigger Data Signal	CPU Usage Signal	edit
Trigger Data Signal Deadband	5.000	edit
Capture When True	---	edit

Data Signals

- Add Data Signal

Name	Field	Field Value	Actions
Application Memory Signal	Vadim's Desk Controller: Available Memory	128.77 MB	edit
CPU Usage Signal	Vadim's Desk Controller: CPU Usage	15 %	edit
CPU Delay Signal	Vadim's Desk Controller: CPU Delay	77 ms	edit

Preview Chart

The chart displays three data signals over 30 samples. The left Y-axis represents Memory (MB) from 10.0 to 128.0. The right Y-axis represents CPU Usage (%) from 0.0 to 45.0. The X-axis represents Samples from 0 to 30. The legend indicates: Application Memory Signal (yellow), CPU Usage Signal (blue), and CPU Delay Signal (red).

3. From the **Configuration** table, click the edit icon to setup the following information:
 - a. **Name** to give the Datalog a name;
 - b. **Description** to describe the purpose or usage of the Datalog;
 - c. **Number Of Samples To Capture** from 60 to 3600 samples;
 - d. **Sampling Method**:

*ADDITIONAL INFORMATION: Datalogs can be configured to either **Sample at Fixed Time Intervals**, or **Sample on Trigger Data Signal Change** in which case a new sample of all Data Signals will be taken only when the **Trigger Data Signal** changes by more*

than the **Trigger Data Signal Deadband** compared to its value when the previous sample was taken.

- e. **Sample Interval** to set the interval from 2 seconds to 3 hours (10800 seconds).
- f. **Trigger Data Signal** is the Data Signal which triggers sampling, when the Sampling Method is set to Sample on Trigger Data Signal Change
- g. **Trigger Data Signal Deadband** determines how much the **Trigger Data Signal** has to change before a new sample is taken.
- h. **Capture When True** to control whether data is captured continuously or only under certain conditions.

ADDITIONAL INFORMATION: If the **Capture When True** value goes unknown, the Datalog will ignore it. If the Datalog is in the waiting state (or the sampling state), when the **Capture When True** value goes unknown, the Datalog will stay in the waiting (or sampling) state it was already in.

- 4. From the **Data Signals** table, click **Add Data Signal** to add the number of data signals you need. Up to 20 signals can be created.
- 5. From the **Configuration** table, click the edit icon to setup the following information for each **Data Signal**:
 - a. **Name** to give the signal a name;
 - b. **Description** if you want to document what the signal means or how its value should be interpreted;
 - c. **Field** to bring up the field picker and select the ADIO input or other value you want to monitor.

ADDITIONAL INFORMATION: You cannot leave data signal fields unknown. You cannot select state or boolean values for data signals.

- 6. Run the **Start Capture** command.

If all of the **Data Signals** are not configured when the Start Capture button is pressed, the capture will still start, but an entry is made in the event log to indicate a Data Signal is not configured.

You can configure the **Datalog** to run at certain times of day, or to stop after a certain time or number of samples, by configuring a boolean **Custom Data** and then configuring **Capture When True** to use it.

If you change the **Data Signals**, **Sampling Method**, **Trigger Data Signal**, **Trigger Data Signal Deadband** or **Number Of Samples To Capture**, that will make the old data is incompatible with the new data. The old data will be deleted when you run the **Start Capture** command.

Transferring Datalogs Configuration to other Controllers

By importing and exporting a configuration file, some datalogs configuration can be transferred to a new controller. A datalog sources information from data signals coming from various physical measurements on its system, and the data signal will only transfer to a new controller if that measurement also exists on the new system.

For example, the Total Load Current is an attribute of the DC System. A datalog measuring the Total Load Current will only transfer to the new controller if it has a DC System in its inventory.

However, signals such as a rectifier's Ambient Temperature measurement are attributes of that specific rectifier. If a configuration file is exported from one controller and imported onto another, the Ambient Temperature data signal will not import, and it will raise an **Invalid Config Ignored** event. The new rectifier will need to be re-configured to the new controller.

10.4.5 Performance Logs

The **Performance Log** holds up to one-year's worth of daily roll-ups with a minimum, maximum and average value for key usage statistics. For systems, this includes: input voltage and current, and the output voltage and current. For the controller, the CPU and memory usage are tracked.

Figure 63: CPU Memory in Use Performance Log



To create the daily roll-ups, the **Performance Log** is rolling up second data into minute data, minute data into hour data and hour data into daily data. The web displays previews of all four sets of data as they are collected. In these previews, the horizontal axis shows the data sampled, not the time stamp. Daily statistics with minimum, maximum, and average values can be exported for each log by clicking the **Export data to CSV** button under the **Days** graph. Or you can export every log by clicking **Export All** via **Logs > Performance Logs**.

If the controller is shut down for some period of time, the preview window will not show the gap in time. If there is a clock error, indicating that the time and date is unknown, a **Performance Log** will not collect data.

10.5 File Maintenance

This section of the manual covers the following:

- Using file preferences to name files
- Upgrading the controller operating system via the LCD
- Upgrading the controller software
- Importing and exporting configuration files
- Exporting diagnostic information
- Importing and exporting license keys
- Exporting a snapshot of controller and system status

10.5.1 File Preferences

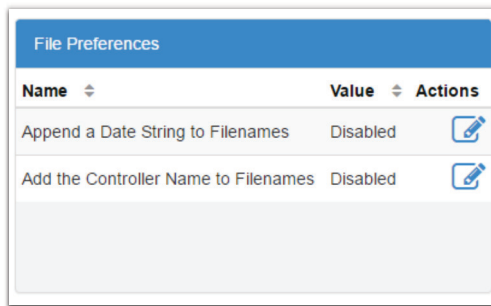
If working with multiple systems, use the file naming options to keep your files organized. You can add the controller name and/or the date to exported and saved files.

If adding a date, the date string format is YYYY-MM-DD making it easy to sort in file browsers.

If adding the controller name, and that name contains whitespace, illegal characters for file names or some extended characters, those characters will be removed from the string that is added to the filename. This naming convention applies to most files that can be saved or exported from the controller for example: configuration files, log files, licensing files and backup files.

To append a name and/or date:

1. Go to **Controller > Configure Controller > User Interface Preferences.**



2. In the **File Preferences** table,
 - click the edit icon in the **Append a Date String to Filenames** field to enable the add date to filenames.
 - click the edit icon in the **Add the Controller Name to Filenames** field to add the controller name to filenames.

10.5.2 File Maintenance via the LCD

To enable more to be done with the LCD screen and USB mass storage devices, most of the file maintenance functions available via the web are also available via the LCD. LCD file operations take place using the top-level or root directory of a FAT32 formatted USB drive.

File operations that are available on both the web and LCD are as follows:

- **Import** and **Export** of configuration files

- **Upgrade** of the controller application software
- **Import** and **Export** of license key files
- **Upgrade** of module application software using ACAN files.

File operations that are available only via the LCD:

- **Backup** and **Restore** of the controller application software and configuration
- **Upgrade** of the controller operating system software

File operations that are available only via the Web:

- **Downloading** of event logs, module alerts, datalogs and tables

LCD Import and Export

On the LCD, go to **Menu > Controller > Advanced Functions > Configuration File**. The **Export Controller Clone** command allows you to export the entire controller configuration to a connected USB drive. The other options **Export System or ADIO** and **Export Partial** are not supported on the LCD. The **Import** command allow you to import configuration files with limitations as noted below.

Alternatively, go to **Shortcuts > Browse USB**. Here you can select a configuration file to perform an **Import**.

***NOTE:** Using the **Import** command from the LCD has limitations. Importing a configuration file that is a clone of a controller will always work. However, importing a configuration file that is for a system, an ADIO or a partial configuration will only work if the import can be achieved unambiguously. For example, if the import is intended to change some configuration for an ADIO, but there are more than one ADIO of the same type it will be ambiguous as to which ADIO should receive the configuration. Therefore the import will fail. In this scenario, the web should be used to do the import so that the user can choose which ADIO should receive the configuration.*

LCD Application Upgrade

There are two ways to upgrade the controller software:

1. On the LCD, go to **Menu > Controller > Advanced Functions > Controller Software Upgrade**. The **Upgrade New Controller Software and Reboot** command will allow you to upgrade the application using an appropriate upgrade (zip) file.
2. On the LCD go to **Shortcuts > Browse USB**. You can upgrade the controller application via an appropriate upgrade (zip) file that has been stored on a USB drive.

The application upgrade takes several seconds. The controller reboots automatically when complete.

Operating System Upgrade

On the LCD, go to **Shortcuts > Browse USB**. You can upgrade the controller operating system via an appropriate upgrade (zip) file that has been stored on a USB drive.

***NOTE:** There must be at least 33 MB of free space to run the Operating System upgrade. To check the available Free Space, goto **Menu > Controller > Configure Controller > Storage and Memory > Application Storage**.*

The operating system upgrade takes several minutes. The controller reboots automatically when the upgrade completes.

Backup and Restore

The **Backup** command allows you to make a full backup of a system so that you can Restore it after. You can access the **Backup** function via the LCD in **Shortcuts > Backup**. The Backup functions will make a copy of both the application software and the configuration information for that version of the application in a single back up file. This includes controller-specific information such as IP addresses, user names and passwords.

A **Scheduled Action** can be configured to automatically back up the controller to a USB drive at configurable intervals. This can be configured in **Controller > Advanced Functions > Advanced Functions > Scheduler**.

If you make a **Backup** of the factory default settings, then you can report the factory defaults. If you make a backup of the fully commissioned working system then you can restore the system to that state.

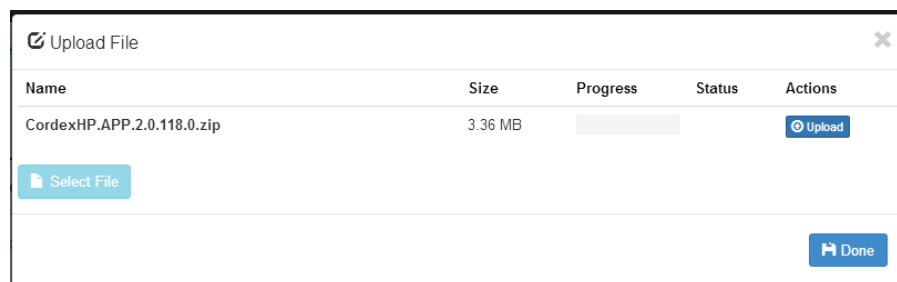
The **Restore** functions allows you to take an existing backup file and restore the contents of that file to the system. All existing application software and configuration information will be deleted and replaced by the contents of the backup file. You can access the Restore function from the LCD in the **Shortcuts > Restore**.

Backup and **Restore** are meant to be used to recover from server errors. If a controller was damaged and needed to be replaced you could use the backup file to restore a new controller to the same settings as the previous controller.

10.5.3 Upgrading the Controller Software

To perform a controller software upgrade:

1. Go to **Controller > Advanced Functions**.
2. Click **Software Upgrade**.
3. Click the **Upload New Controller Software and Reboot** button.
4. From the Upload File window, click **Select File**, and then select the upgrade file.



5. Select the controller upgrade .azp file.
6. After the upgrade is finished, the controller resets automatically.

Once complete, the **Login** page displays and you must log back in to the controller.

After an upgrade, it is common to see a number of Event Log entries showing configuration fields being set. This is normal on an upgrade when the system needs to set up new features or options that have been added.

10.5.4 Exporting Configuration

There are three options when exporting a configuration file.

Export Controller Clone: is used to transfer the entire configuration. A common use for this type of export is to make a back-up of the current settings. When using this export, almost all information is saved to the exported file. See the note below for an explanation of what is not included in the export file.

Export System or ADIO: is a way to copy a system or an ADIO to another controller. Only a single system or an ADIO may be selected. If selecting system, any ADIO referenced by that system is also exported. For example, if an L-ADIO is used for voltage measurements and 6I-ADIO is used for shunt measurements they are saved to the export file.

Export Partial: is used to select a specific set of information for export. This is commonly used for transferring user alarms, custom data, alarm thresholds or other configured data that may need to be common between controllers. A partial export must be performed on a set of related configurations. The wizard allows you to select either a controller, a system or an ADIO. After the selection is made, all associated configurations are presented in a list and are exported by selecting the check-box. For example: to export a set of custom data, select controller; to export a set of DC System alarm configurations, select the required system from the drop-down list. If any of the selected configuration references an ADIO, that ADIO is also exported.

Some items must be exported as a whole. This includes items that can be created and removed by a user (other than systems or items that are permanent to the controller. For example if selecting:

- controller: you can export a whole SNMP destination, but not a particular configuration within a destination; or if exporting custom data, you can export a whole custom data with all its variables, but not a specific variable defined within the custom data. The same applies to user alarms, data-logs, schedules.
- DC system: you can export a whole load, shunt or disconnect, but not the configuration within these items.

NOTE: *Some configuration can never be exported:*

- Controller description and location information (this is unique to each controller)
- IP configuration (to avoid loss of Ethernet connectivity)
- Web server port configuration (to avoid loss of Ethernet connectivity)
- Line power channels (unique to line power modules)
- Power module (power modules are unique to a system)
- Users (to maintain password security)
- Server passwords (e.g. email server password; to maintain password security)

To export settings:

1. From the main dashboard go to, **Controller > Advanced Functions > Configuration File**.
2. Click the type of export required:
 - **Export Controller Clone**: a file is generated and uploaded to your browser.
Export System or ADIO: A wizard displays in which you can select a System or an ADIO. Select an item to export and then click **Next**. Use the **Download File** option to save your export file.
Export Partial: A wizard displays in which you can select a configuration source, click **Next**. In the **Select Configuration to Export** window, select each configuration item for export, click **Next**. Review the items from your selected configuration and use the **Download File** option to save your export file.
3. To help distinguish among configuration files rename your export file with a unique identifier. This can be important when making a back-up files for archiving or if a controller replacement is required.

10.5.5 Importing Configuration

When importing a configuration file, the controller will analyze the file to determine the type of import to perform. There are three types of import corresponding to the three types of export.

Clone

Clone is performed when a file that has been exported using **Export Clone Controller** is uploaded. The configuration of the controller is matched to that contained in the file. In addition all existing systems, custom data, timers, counters, datalogs are removed. Clone is also performed if a configuration file from a version previous to v4.00 is uploaded.

Copy System or ADIO

Copy system or ADIO is performed when a file that has been exported using **Export System or ADIO** is uploaded. The system or ADIO contained in the file is added to the controller. If a system is being imported, the new system is created and added to the controller under the **System** menu. If importing a DC System and a DC System already exists the import will fail because only one DC System is supported. It is necessary to first delete the existing DC System before doing the import. This also applies to Converter Systems. All other types of systems do not have this limitation. If importing an ADIO, the ADIO is added under the **Modules** page. After importing the ADIO, use the **Replace ADIO** command to transfer the configuration of the imported ADIO to an existing ADIO.

Partial Import

Partial import is performed when a file that has been exported using **Export Partial** is uploaded. The configuration contained in the file replaces that of any matching existing configuration settings. It is possible that the destination of the imported configuration cannot be automatically determined. For example, if configuration for a Line System is imported and there exists more than one Line System, the user will be required to select the which system should receive the configuration. Partial Import can also be used to transfer custom data, counters and timers from one controller to another.

Importing may not always be fully successful. Configuration values that point to another value, such as 'source' values that point to voltage, current or temperature, may not exist or may be ambiguous. If this is the case, the value is ignored and an entry is made in the event log. It is then necessary to remap the source field to a valid value.

NOTE: *Some configuration can never be exported:*

- Controller description and location information (this is unique to each controller)
- IP configuration (to avoid loss of Ethernet connectivity)
- Web server port configuration (to avoid loss of Ethernet connectivity)
- Line power channels (unique to line power modules)
- Power module (power modules are unique to a system)
- Users (to maintain password security)
- Server passwords (e.g. email server password; to maintain password security)

To import settings:

1. From the main dashboard go to, **Controller > Advanced Functions > Configuration File**.
2. Click the **Import** button, select a file to import and click the **Upload** button.
3. If the configuration cannot be imported without ambiguity, there will be a drop-down list to select the destination system or ADIO. This only happens if trying to do a partial import. Select the destination system and click **Next**.
4. A page displaying an **Import Summary** is shown. Review the summary and click **Next** to import. If the summary looks incorrect, you can close the wizard and try **Import** again to select another file.
5. Perform **Replace ADIO** if required. When this operation is done, the controller gives special attention to the status of relays mapped to a disconnect. If, as a result of the replace operation, a disconnect relay will be shared with an alarm relay or if the state of a disconnect relay will change because of a change to the relay polarity, the replace will fail and an entry made in the event log identifying the alarm relay was causing the failure.

Importing a System

It is common to create a system on the controller that has been already configured on a different controller. This can be done by first exporting a configuration file from the already configured controller, then importing it. When exporting, choose the appropriate export method, either clone or copy, as previously described.

To import a system in a configuration file:

1. Go to **Controller > Advanced Functions > Configuration File**.
2. Press the **Import** button to launch the import wizard.
3. Use **Select File** to browse to the configuration file on your local computer (e.g. exportconfig.xml).
4. Click **Upload** to upload the file to the controller.
5. Review the **Import Summary** page. This shows a summary of what you are about to import. If it is not correct, close the wizard and start over to select a different configuration file.

6. Press **Next**, and then wait for the import to complete. If the import fails or encounters an error an error message is displayed.
7. Perform **Replace ADIO**, if necessary. If the imported system referenced one or more ADIOs the import included these ADIOs, and they now show up as **Comms Lost**. You should replace these **Comms Lost** ADIOs with existing ADIOs of the same type via the **Modules** page.

The system has been imported and configured to use the existing ADIO.

10.5.6 Exporting Diagnostic Information

***IMPORTANT:** To facilitate any support request, export a diagnostic information package before contacting Alpha Technologies.*

Exporting a diagnostic information package helps Alpha provide assistance with any issues you may experience. This information package is an archive that contains the following:

- Controller clone
- Device Log
- Event Log
- Battery Log
- Daily statistics for all Performance Logs
- Datalogs

Additionally, if any T2S modules for the AMPS HP2 system are acquired, an additional step will be available in the **Export Diagnostic Information** wizard to include their logs and configuration files in this package.

To Export a Diagnostic Information Package

This package can be obtained in the following ways, via the LCD or via the web.

1. From the dashboard of the LCD, go to **Shortcuts > Export Diagnostic Information** to launch a wizard that will generate save the package to a USB drive.
2. From the web click on the **Accounts and Shortcuts > Export Diagnostic Information** on the top bar to launch a wizard that will generate the file and let you download the file to your computer.

10.5.7 Exporting Inventory

A common system maintenance activity is to gather, record and archive a set of data about the controller and systems. This can be a tedious process depending on the amount of data required. To facilitate this the CXC HP controller provides a set of data, both live status data and configuration,

as a downloadable file. This file contains most of the information that is viewable from the LCD and WEB UI and serves as a snapshot of the present state of the controller.

To download this file:

1. If using a controller with the LCD or OLED display, insert a USB drive.
2. Go to the menu location to find the download button:
 - a. On the LCD, go to **Maintenance** and scroll down to the **Export Inventory to CSV** button and press it.
 - b. On the WEB, go to **Controller > Inventory** and press the **Export Inventory to CSV** button in the **Inventory** table.
 - c. On the in-shelf controller with the OLED display, press the **Menu** button and scroll down to **Explnv** and press the **Menu** button again.
3. Press the **Export** button to initiate the download.

Once started, the file is downloaded to the USB drive or PC depending on where the export was initiated from. If initiated from the LCD or OLED display it is downloaded to the USB drive. If initiated from the WEB it is downloaded to the PC. Depending on the amount of data to download, it may take several minutes to complete.

This file can now be opened in a spreadsheet program for analysis.

***NOTE:** Sensitive data related to users and user permissions, passwords, and licensing is not included in the exported file.*

10.6 User Account Maintenance

10.6.1 Setting Up Users and Permissions

***NOTE:** These features are only available to those with Administrator or Account Manager privileges.*

By default the CXC HP has seven user accounts: one administrator, one account manager and five operators. The Name field in these accounts is not editable. User accounts cannot be added or deleted, but they can be enabled or disabled.

Within the **Users and Security** menu you can use the **User Roles** drop-down menu to configure what privileges each user has when accessing the system or changing passwords.

This section of the manual covers the following:

- Editing user permissions
- Enabling new users
- Disabling users

10.6.2 Editing User Permissions

These features are only available to those with Administrator or Account Manager privileges.

To edit user permissions:

1. Go to **Controller > Configure Controller > Users and Security**.
2. From the **User** table, click the see more details icon on the line of user whose access must be changed.
3. On the right-side of the User Role line, click the edit icon.
4. From the drop-down menu, set the **User Role** and click **Save**.

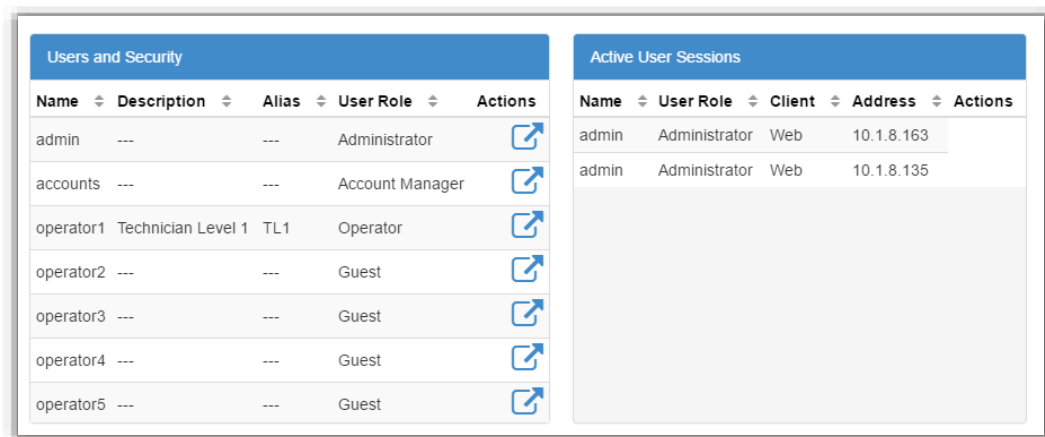
10.6.3 Enabling New Users

Within the **Users and Security** menu you can enable, edit and disable users. Only users with Administrator or Account Manager privileges can enable users. Within the **User Roles** drop-down menu you can configure the privileges each user has as well as create passwords. The different levels of user permissions are as follows:

- Administrator - Can modify all configurations, perform any actions with the exception of factory information
- Account Manager - Can only create and modify user accounts
- Operator - Can modify all configurations, can change their own password
- Restricted Operator - Can modify configuration values, but cannot add or remove systems or inventory, can change their own password
- Guest - Can read any field, but can not configure any settings

To enable a user:

1. Go to **Controller > Configure Controller > Users and Security**.
2. From the **User** table, click the see more details icon on the operator1 line.

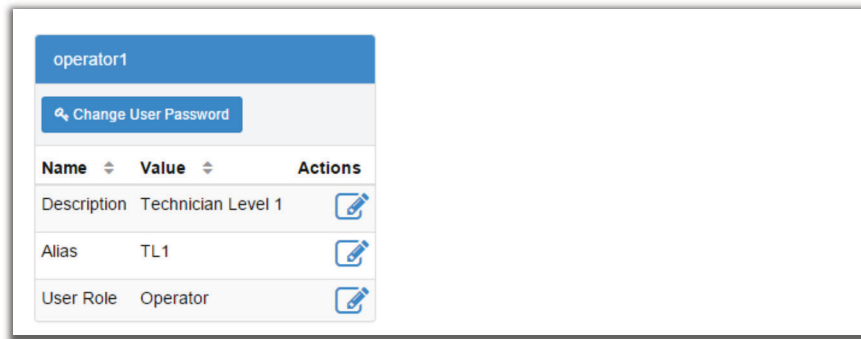


The screenshot displays two side-by-side tables. The left table, titled 'Users and Security', lists users with columns for Name, Description, Alias, User Role, and Actions. The right table, titled 'Active User Sessions', lists active sessions with columns for Name, User Role, Client, Address, and Actions.

Users and Security				
Name	Description	Alias	User Role	Actions
admin	---	---	Administrator	
accounts	---	---	Account Manager	
operator1	Technician Level 1	TL1	Operator	
operator2	---	---	Guest	
operator3	---	---	Guest	
operator4	---	---	Guest	
operator5	---	---	Guest	

Active User Sessions				
Name	User Role	Client	Address	Actions
admin	Administrator	Web	10.1.8.163	
admin	Administrator	Web	10.1.8.135	

- Optional: Edit the **Description** and click **Save**.



The screenshot shows a user profile for 'operator1'. At the top, there is a blue header with the name 'operator1' and a 'Change User Password' button. Below this is a table with three columns: 'Name', 'Value', and 'Actions'. The table contains three rows: 'Description' with value 'Technician Level 1', 'Alias' with value 'TL1', and 'User Role' with value 'Operator'. Each row has a pencil icon in the 'Actions' column.

Name	Value	Actions
Description	Technician Level 1	
Alias	TL1	
User Role	Operator	

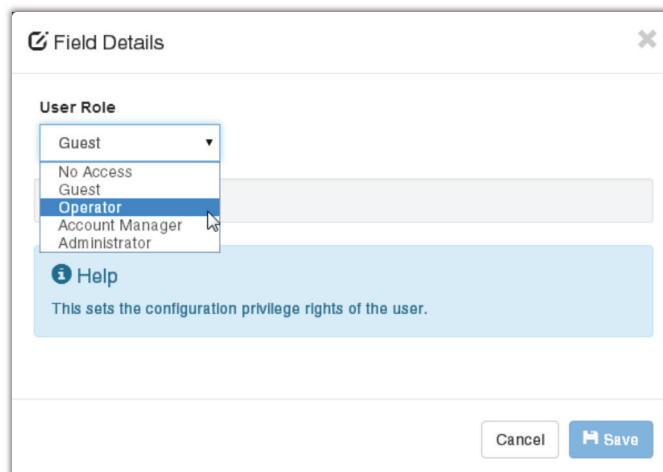
- Optional: Edit the **Alias** and click **Save**.



The screenshot shows a login page with a blue background and the 'alpha TECHNOLOGIES™' logo. There is a circular icon with a person silhouette at the top. Below the logo are two input fields: the first contains 'TL1' and the second contains '....'. A 'LOGIN' button is at the bottom.

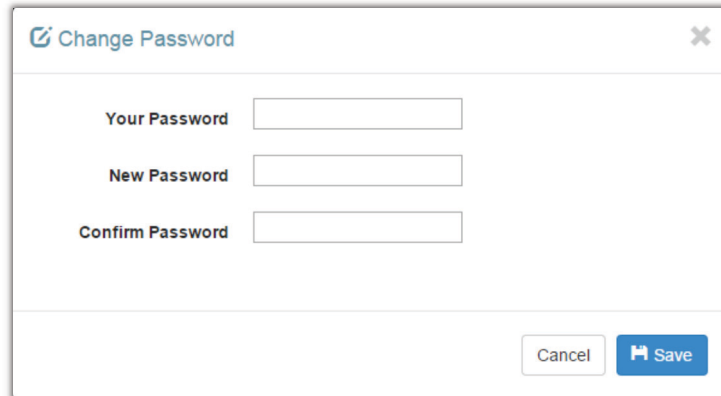
The alias field allows login names that a user is more familiar with. For example, if you set the operator1 alias to TL1, you can login to the operator1 account using the TL1 user name.

- Set the **User Role** (permissions) and click **Save**.



The screenshot shows a 'Field Details' dialog box. The 'User Role' dropdown menu is open, showing options: 'Guest', 'No Access', 'Guest', 'Operator', 'Account Manager', and 'Administrator'. The 'Operator' option is selected. Below the dropdown is a 'Help' section with an information icon and the text: 'This sets the configuration privilege rights of the user.' At the bottom right are 'Cancel' and 'Save' buttons.

- From the operator1 table, click **Change User Password** to set the password and click **Save**.



A dialog box titled "Change Password" with a close button (X) in the top right corner. It contains three text input fields labeled "Your Password", "New Password", and "Confirm Password". At the bottom right, there are two buttons: "Cancel" and "Save".

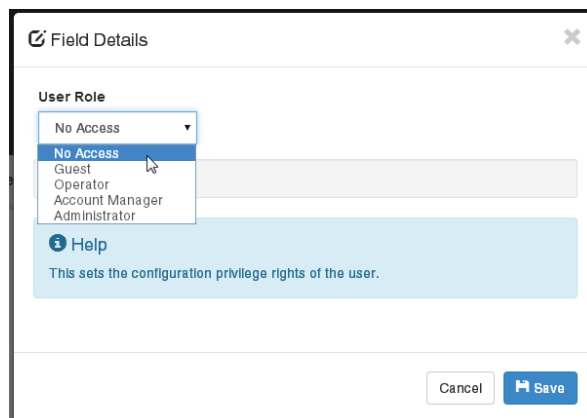
- Login using the updated password or permissions.

10.6.4 Disabling Users

These features are only available to those with Administrator or Account Manager privileges. User accounts are not actually deleted, they are edited to remove a user's access to the system.

To disable users:

- Go to **Controller > Configure Controller > Users and Security**.
- From the **User** table, click the more details icon on the line of user whose access must be changed.
- On the right-side of the **User Role** line, click the edit icon.
- From the drop-down menu, set the User Role to **No Access**.



A dialog box titled "Field Details" with a close button (X) in the top right corner. It features a "User Role" section with a dropdown menu. The dropdown menu is open, showing options: "No Access", "Guest", "Operator", "Account Manager", and "Administrator". The "No Access" option is highlighted. Below the dropdown is a "Help" section with an information icon and the text: "This sets the configuration privilege rights of the user." At the bottom right, there are two buttons: "Cancel" and "Save".

- Click **Save**.

10.6.5 Changing the Default Password - LCD

This section describes how to change user passwords from the LCD.

PREREQUISITE:

You must be logged in to the controller to change passwords.

To change the default password:

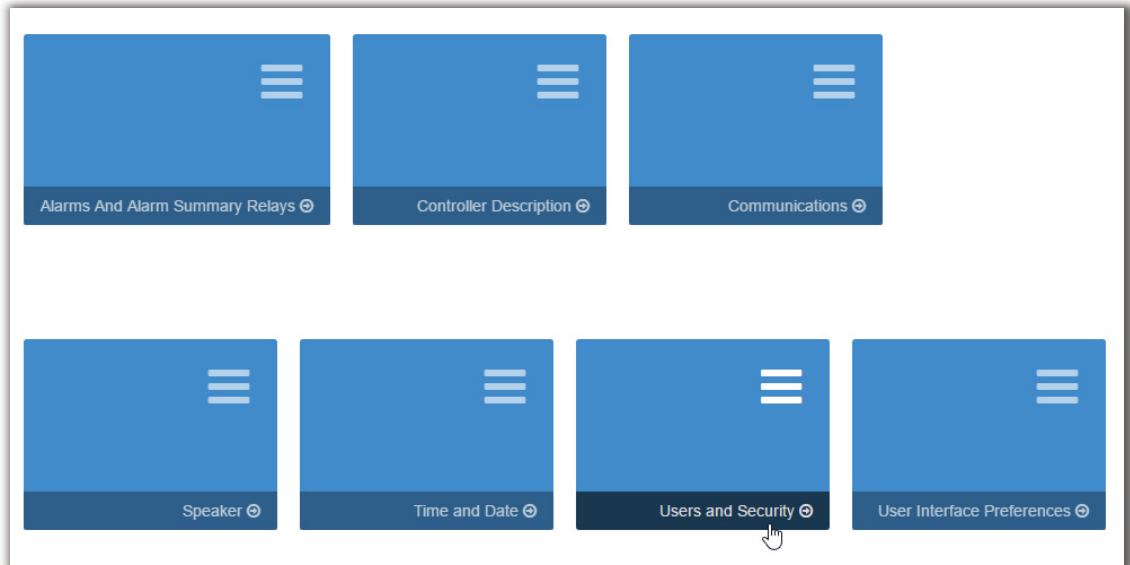
1. From the main Dashboard, click the **Menu** button.
2. Press **Controller** to highlight it, and then press the arrow on the right-side.
3. Press to highlight **Configure Controller**, and then press the arrow on the right-side.
4. Swipe with an upward motion on the touch screen to scroll down to **Users and Security**, and press to highlight.
5. Press the arrow on the right-side, and then select **admin**.
6. Press **Change User Password**.
7. Press the **Execute** button to modify the default, and then click the checkmark to save your changes.

10.6.6 Changing the Default Password - Web

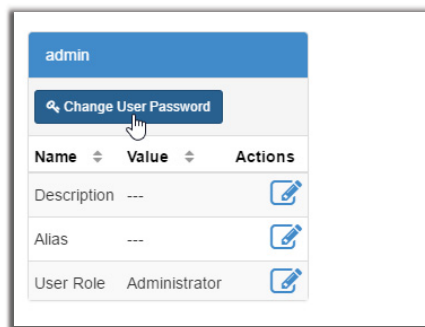
This section describes how to change the default password via the web interface.

To change the default password via the web:

1. From the main dashboard, go to **Controller > Configure Controller > Users and Security**.



2. From the **admin** line, click the **more details** icon on the right-side of the table.
3. From the table, click the **Change User Password** button.



4. Enter a new password and then click **Save**.

10.6.7 Remote Configuration Lockout

The Remote Configuration Lockout feature allows for a complete lockout of configuration changes from the Web UI. When this feature is active, no user, regardless of permission level, will be able to change or modify the configuration via the Web UI. Configuration changes will still be possible via the LCD.

To enable this feature:

1. On the LCD, go to **Maintenance > Remote Configuration Lockout**.
2. Click the edit icon beside **Remove Configuration Lockout**, change the value to **Disabled** (logging in if required), then save.
3. Click the edit icon beside **Lockout Override Time**, enter in the desired time to override the lockout (more on the override below), then save.

After Remote Configuration Lockout is enabled, no configuration changes will be allowed from the Web UI.

10.7 Module Firmware Upgrades

This section covers how to upgrade the firmware on CAN devices attached to the controller.

10.7.1 Module Firmware Upgrade

To upgrade the firmware on a module, go to **Menu > Modules > Firmware Upgrade** table from either the web or the LCD touchscreen.

Figure 64: Module Upgrade Page - web

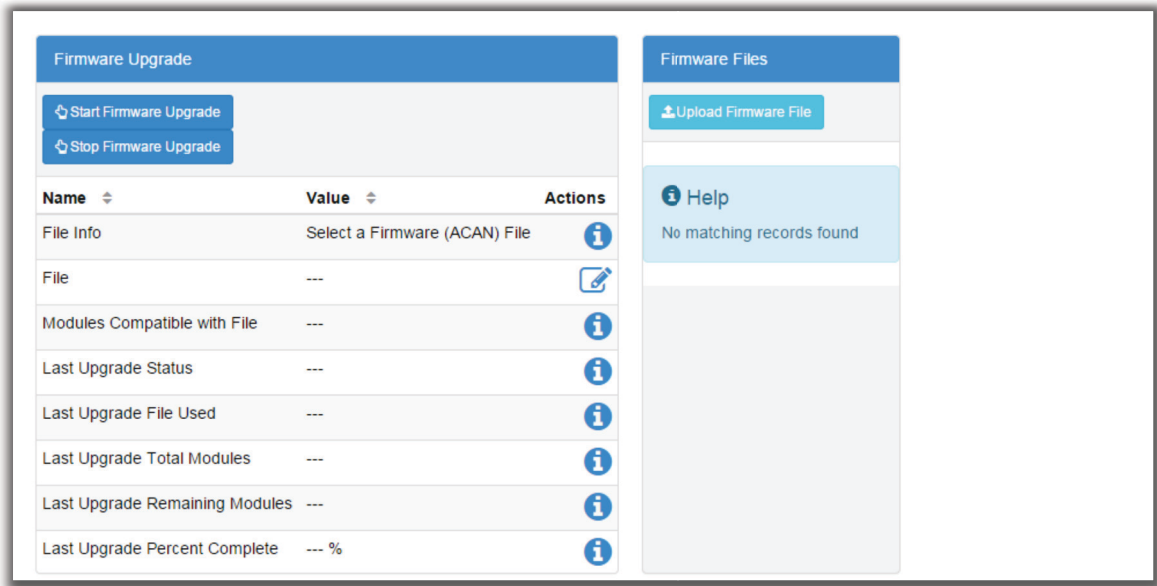
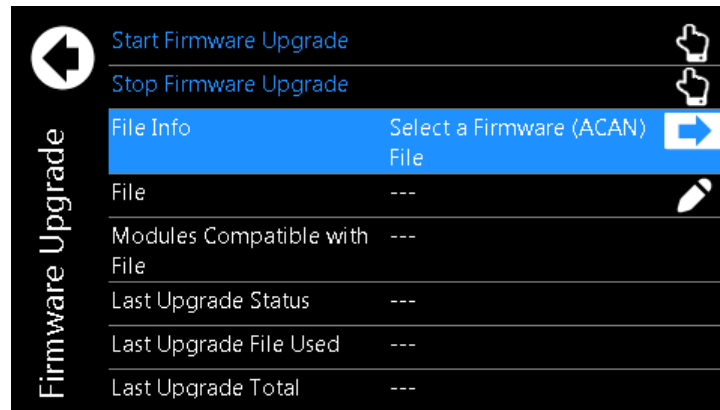


Figure 65: Module Upgrade - LCD



10.7.2 Uploading a Firmware File

Uploading a Firmware File from the LCD

From the LCD you can either choose a file uploaded from a USB drive or one from the **Local Files** folder. The **Local Files** menu contains a list of files previously uploaded via the web. Go to **Menu > Modules > Firmware Upgrade > File**.

Uploading a Firmware File from the Web

To upgrade a module over the web, the firmware file must be uploaded to the controller first.

1. Go to **Modules > Firmware Files**, and click **Upload Firmware File** table.

Figure 66: Firmware Files Table

The screenshot shows a web interface for managing firmware files. At the top, there's a navigation bar with 'All Modules' and buttons for 'Assign All Modules' and 'Forget Power Modules in Comms Lost'. Below this is a table with columns: Identity, Model, Firmware, System, Bus, Node, Comm. Status, Alerts, and Actions. The first row shows: 6I-ADIO/378000014, 6I-ADIO, 1.01, Test Site 10 (Controller), CAN1, 2, Normal, and buttons for 'Locate', 'Replace ADIO', and a refresh icon.

Below the table are two panels. The left panel is titled 'Firmware Upgrade' and contains buttons for 'Start Firmware Upgrade' and 'Stop Firmware Upgrade'. Below these is a table with columns: Name, Value, and Actions. The rows include: File Info (Select a Firmware (ACAN) File), File (---), Modules Compatible with File (---), Last Upgrade Status (---), Last Upgrade File Used (---), Last Upgrade Total Modules (---), Last Upgrade Remaining Modules (---), and Last Upgrade Percent Complete (--- %).

The right panel is titled 'Firmware Files' and contains a button for 'Upload Firmware File'. Below this is a table with columns: Name, Last Write, Size (bytes), and Actions. The rows include: BDFB_1.05.acan, 0350122-001_A_SMARTE2_CUSTOMER_V1.02.ACAN, 0350078-001_C_6IADIO_APP_V1.01.acan, 0350055-001_G_LADIO_APP_V1.03.acan, 0350122-001_A_SMARTE2_CUSTOMER_V1.00.acan, 0350115-001_E_BDFB_CUSTOMER_V1.04.acan, and 6I_ADIO_V1.00.acan. Each row has a 'Delete File' button.

2. An **Upload File** dialog displays.
3. Click the **Select File** and choose the file to upload. Once a firmware file is selected, click the **Upload** button.

Figure 67: Upload File Dialog

The screenshot shows a dialog box titled 'Upload File' with a close button (X) in the top right corner. The dialog contains a table with columns: Name, Size, Progress, Status, and Actions. The first row shows: 0350055-001_F_APP_LADIO_V1.02.acan, 0.06 MB, a progress bar, and an 'Upload' button. Below the table is a 'Select File' button and a 'Close' button in the bottom right corner.

Once the file is uploaded, the dialog closes. The uploaded file is now visible in the **Firmware Files** table and available to upgrade a module.

10.7.3 Selecting the File to Upgrade

In the **Firmware Upgrade** table, there are buttons at the top to start or stop the firmware upgrade. These buttons are not active until a firmware file is selected. The first three rows of the **Firmware Upgrade** table display information about the selected upgrade file.

The rest of the table rows show information about the last upgrade that occurred. In the following **Ready to Start Upgrade** figure, the controller has been recently reset and no upgrade history displays.

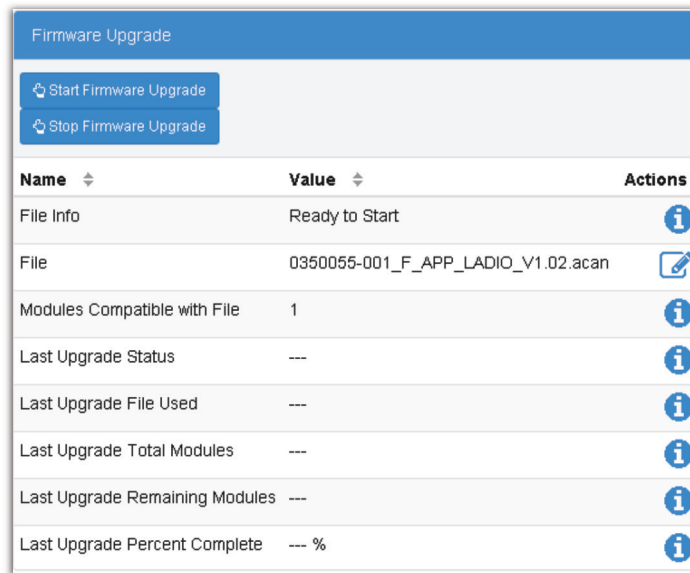
The **File Info** field is informational, it displays information about how to proceed with an upgrade. Before a file is selected it displays the message, **Select a Firmware (ACAN) File**.

The **File** field is used to select a file for the upgrade. From the web, the upgrade file must be chosen from those previously uploaded to the controller. On the LCD, you can select either from the list of previously uploaded files (Local Files), or from a USB drive.

Once a file is selected, the first three rows of the table are updated with new status. If the file chosen is not a valid upgrade file, or if there are no modules to which that file can be applied, the number of **Modules Compatible With File** will be 0, and the **File Info** field will say, **Select a Different Firmware File**.

If the file is valid and applicable to your modules the **Modules Compatible With File** field will display how many devices need to be upgraded, and the **File Info** field will display **Ready to Start**. If the number of **Modules Compatible With File** is smaller than you expected or zero, it may be because some or all of the modules have already been upgraded to this version. There is no need reload a module with the same version of firmware. If the firmware is corrupt, the module will detect it and go into a **Waiting for Software** state.

Figure 68: Ready to Start Upgrade



The screenshot shows a web interface titled "Firmware Upgrade". At the top, there are two buttons: "Start Firmware Upgrade" and "Stop Firmware Upgrade". Below these is a table with three columns: "Name", "Value", and "Actions". The table contains the following rows:

Name	Value	Actions
File Info	Ready to Start	
File	0350055-001_F_APP_RADIO_V1.02.acan	
Modules Compatible with File	1	
Last Upgrade Status	---	
Last Upgrade File Used	---	
Last Upgrade Total Modules	---	
Last Upgrade Remaining Modules	---	
Last Upgrade Percent Complete	--- %	

If an upgrade has been completed since the last restart, the bottom rows of the table will still contain information about that last upgrade until the **Start Firmware Upgrade** button is pressed.

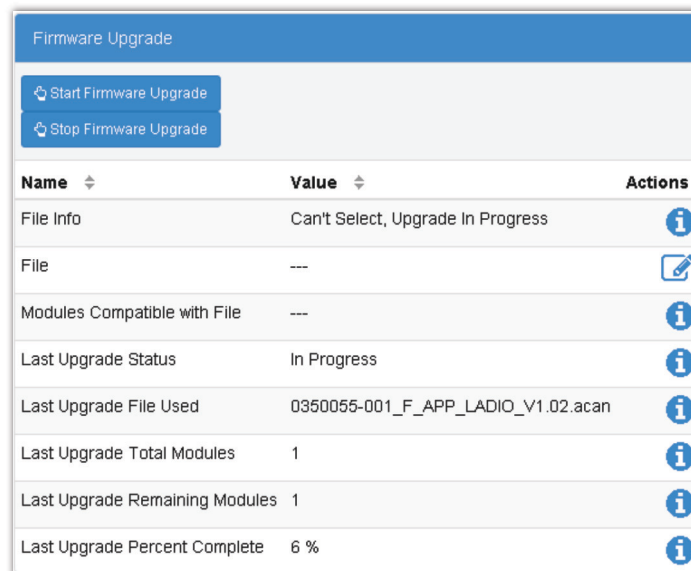
10.7.4 Upgrading the Module

Once a valid firmware file is uploaded and the **File Info** field displays, **Ready to Start**, click **Start Firmware Upgrade**.

As the upgrade progresses, the **Firmware Upgrade** table updates with information about the upgrade. The **Last Upgrade Percent Complete** counts up from 0%, and then **Last Upgrade Remaining Modules** counts down (if there is more than one module being upgraded).

If there is more than one module being upgraded, the percent complete will show the total (100% will be reached once all modules are upgraded) instead of a per-module completion.

Figure 69: Upgrade in Progress



Name	Value	Actions
File Info	Can't Select, Upgrade In Progress	
File	---	
Modules Compatible with File	---	
Last Upgrade Status	In Progress	
Last Upgrade File Used	0350055-001_F_APP_RADIO_V1.02.acan	
Last Upgrade Total Modules	1	
Last Upgrade Remaining Modules	1	
Last Upgrade Percent Complete	6 %	

The firmware upgrade can be stopped if necessary. If you press **Stop Firmware Upgrade** button the controller finishes upgrading the current module so as not to leave it in a non-functional state. If multiple modules are queued, the next module will not be upgraded.

If the upgrade fails on a module, the controller stops the upgrade and will not attempt to continue on any further modules that have been queued.

Once the upgrade is finished, the **Last Upgrade Percent Complete** displays **100%**, and the **Last Upgrade Status** displays **Succeeded**.

Figure 70: Upgrade Succeeded

Firmware Upgrade		
Start Firmware Upgrade		
Stop Firmware Upgrade		
Name	Value	Actions
File Info	Select a Firmware (ACAN) File	i
File	---	✎
Modules Compatible with File	---	i
Last Upgrade Status	Succeeded	i
Last Upgrade File Used	0350055-001_F_APP_LADIO_V1.02.acan	i
Last Upgrade Total Modules	1	i
Last Upgrade Remaining Modules	0	i
Last Upgrade Percent Complete	100 %	i

11 Appendix A - Triggers

FXM HP works solely with *Level Toggle* triggers.

When the **Active When** field is set to **Circuit Closed**, the FXM HP is triggered to perform the assigned action when the **User Input** pin is shorted to common.

When the **Active When** field is set to **Circuit Open**, the FXM HP is triggered to perform the assigned action when the **User Input** circuit is open.

To configure the user input's active level:

1. Go to **Module**.
2. In the **All Module** table, click on the detail icon of the FXM-HP module.
3. In the **Digital Inputs** table, click on the detail icon of the user input.
4. In the selected user input table, click on the edit icon of **Active When**.
5. Select **Circuit Open** or **Circuit Close** to configure the trigger level of the use input.

12 Warranty and Service Information

12.1 Technical Support

In Canada and the USA, call toll free 1-888-462-7487.

Customers outside Canada and the USA, call +1-604-436-5547.

12.2 Warranty Statement

For full information details review Alpha's online Warranty Statement at www.alpha.ca.

12.3 Product Warranty

Alpha warrants that for a period of three (3) years from the date of shipment its products shall be free from defects under normal authorized use consistent with the product specifications and Alpha's instructions, the terms of the manual will take precedence. The warranty provides for repairing, replacing or issuing credit (at Alpha's discretion) for any equipment manufactured by it and returned by the customer to the factory or other authorized location during the warranty period. There are limitations to this warranty coverage. The warranty does not provide to the customer or other parties any remedies other than the above. It does not provide coverage for any loss of profits, loss of use, costs for removal or installation of defective equipment, damages or consequential damages based upon equipment failure during or after the warranty period. No other obligations are expressed or implied. Warranty also does not cover damage or equipment failure due to cause(s) external to the unit including, but not limited to, environmental conditions, water damage, power surges or any other external influence. The customer is responsible for all shipping and handling charges. Where products are covered under warranty Alpha will pay the cost of shipping the repaired or replacement unit back to the customer.

12.4 Battery Warranty

Note that battery warranty terms and conditions vary by battery and by intended use. Contact your Alpha sales representative or the Technical Support team at the above number to understand your entitlements under Battery Warranty.

12.5 Warranty Claims

Any claim under this Limited Warranty must be made in writing to Alpha BEFORE sending material back. Alpha will provide Product return instructions upon approval of return request. A Service Repair Order (SRO) and / or Return Authorization (RA) number will be issued ensuring that your service needs are handled promptly and efficiently. Claims must be made online at: www.alpha.ca.

12.6 Service Information

For a list of international service centers, visit: www.alpha.ca.

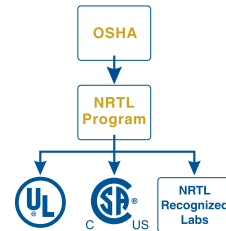
13 Certification

CSA (Canadian Standards Association also known as CSA International) was established in 1919 as an independent testing laboratory in Canada. CSA received its recognition as an NRTL (Nationally Recognized Testing Laboratory) in 1992 from OSHA (Occupational Safety and Health Administration) in the United States of America (Docket No. NRTL-2-92). This was expanded and renewed in 1997, 1999, and 2001. The specific notifications were posted on OSHA's official website as follows:

- Federal Register #: 59:40602 - 40609 [08/09/1994]
- Federal Register #: 64:60240 - 60241 [11/04/1999]
- Federal Register #: 66:35271 - 35278 [07/03/2001]

When these marks appear with the indicator “C and US” or “NRTL/C” it means that the product is certified for both the US and Canadian markets, to the applicable US and Canadian standards. (1)

Alpha rectifier and power system products, bearing the aforementioned CSA marks, are certified to CSA C22.2 No. 60950-01 and UL 60950-1. Alpha UPS products, bearing the aforementioned CSA marks, are certified to CSA C22.2 No. 107.3 and UL 1778. As part of the reciprocal, US/Canada agreement regarding testing laboratories, the Standards Council of Canada (Canada's national accreditation body) granted Underwriters Laboratories (UL) authority to certify products for sale in Canada. (2) Only Underwriters Laboratories may grant a license for the use of this mark, which indicates compliance with both Canadian and US requirements.(3)



NRTL's Capabilities

NRTLs are third party organizations recognized by OSHA, US Department of Labor, under the NRTL program. The testing and certifications are based on product safety standards developed by US based standards developing organizations and are often issued by the American National Standards Institute (ANSI). (4) The NRTL determines that a product meets the requirements of an appropriate consensus-based product safety standard either by successfully testing the product itself, or by verifying that a contract laboratory has done so, and the NRTL certifies that the product meets the requirements of the product safety standard. (4)

Governance of NRTL

The NRTL Program is both national and international in scope with foreign labs permitted.

(1) www.csagroup.org

(2) www.scc.ca

(3) www.ulc.ca

(4) www.osha.gov

