



# User Manual Innovative Energies Power Supply Serial Modbus Protocol Converter with Ethernet Port

Supports Serial Modbus RTU, Modbus TCP & HTTP

**PROTOCONMB-OE**

(DZC-eProtocon-IE1)

Revision: 3

Revision Date: Sep 2011

## TABLE OF CONTENTS

<b>TABLE OF CONTENTS</b> .....	<b>2</b>
<b>INTRODUCTION</b> .....	<b>4</b>
<b>DEVICE SCHEMATIC AND IO CONNECTIONS</b> .....	<b>5</b>
CONNECTIONS:.....	5
WIRING DIAGRAMS.....	5
<b>SERIAL PROGRAMMING CABLE</b> .....	<b>6</b>
<b>FRONT PANEL INDICATIONS</b> .....	<b>7</b>
<b>DEVICE SETUP</b> .....	<b>8</b>
PROGRAMMING SOFTWARE.....	8
RESETTING TO DEFAULT COMMUNICATION SETTINGS .....	8
<b>SPECIFICATIONS</b> .....	<b>8</b>
ELECTRICAL.....	8
COMMUNICATIONS .....	8
PROTOCOLS .....	8
<b>MODBUS RTU AND MODBUS TCP PROTOCOLS</b> .....	<b>9</b>
READ ONLY REGISTERS .....	9
POWER SUPPLY READ ONLY COILS (NEW REGISTER SET) .....	10
POWER SUPPLY READ ONLY COILS (OLD REGISTER SET) .....	11
DIGITAL I/O READ ONLY COILS .....	12
READ/WRITE COILS.....	12
<b>SNMP</b> .....	<b>13</b>
MANAGEMENT INFORMATION BASE (MIB) FILE .....	13
<i>Device Identification (OID 1.3.6.1.4.1.38586.1.1)</i> .....	13
<i>Readings (OID 1.3.6.1.4.1.38586.1.2)</i> .....	13
<i>Information Digitals (OID 1.3.6.1.4.1.38586.1.3)</i> .....	13
<i>Alarm Digitals (OID 1.3.6.1.4.1.38586.1.4)</i> .....	13
<i>Control (OID 1.3.6.1.4.1.38586.1.5)</i> .....	13
<i>Traps (OID 1.3.6.1.4.1.38586.1.6)</i> .....	13
SNMP PROTOCOL COMPATIBILITY .....	14
SOFTWARE.....	14
SNMP WALK TEST .....	15
OID DESCRIPTIONS .....	16
<i>Objects</i> .....	16
<i>Traps</i> .....	18

<b>HTTP AND WEB PAGE PROGRAMMING.....</b>	<b>19</b>
INTRODUCTION.....	19
HTML STRING DECONSTRUCTION - MONITORING OF AN ANALOGUE VALUE .....	20
<i>Bytes</i> .....	20
<i>Bytes Descriptions</i> .....	20
<i>HTML Address Examples</i> .....	20
<i>Screenshot Examples</i> .....	21
HTML STRING DECONSTRUCTION - MONITORING OF A DIGITAL VALUE.....	22
<i>Screenshot Examples</i> .....	23
HTML STRING DECONSTRUCTION - CONTROL OF AN ANALOGUE VALUE.....	25
<i>Screenshot Examples</i> .....	26
HTML STRING DECONSTRUCTION - CONTROL OF A DIGITAL VALUE.....	28
<i>Screenshot Examples</i> .....	28
POWER SUPPLY PARAMETERS IN HTML FORMAT: .....	30
<i>Read Only Analogue Parameters</i> .....	30
<i>Read/Write Digital Parameters</i> .....	30
<i>Read Only Digital Parameters</i> .....	31
INTEGRATING ANALOGUE AND DIGITAL VALUES INTO A WEB PAGE .....	32
<i>Pre-Configured Web Pages</i> .....	32
<i>Adding a host reference to the host file</i> .....	33
<i>Creating a Web Page with information from the Ethernet Device</i> .....	34
<i>HTML Code Examples:</i> .....	34
<b>POWER ETHERMBLINK – PROTOCOL CONVERTER CONFIGURATION AND MONITORING</b>	
<b>SOFTWARE .....</b>	<b>41</b>
COMMUNICATION SETTINGS.....	41
POWER SUPPLY MONITORING TAB .....	43
CONFIGURATION DATA TAB.....	45
MODBUS MONITOR TAB.....	46
MODBUS MONITOR CONTROL .....	48
DEVICE INFORMATION TAB.....	50
<b>REVISION HISTORY .....</b>	<b>51</b>

## INTRODUCTION



The DZC-eProtoCon-IE1 is a protocol converter which connects to the following Innovative Energies Power Supply models:

- SR100i, SR250i, SR500i, SR750i
- SR100L, SR250L, SR500L, SR750L

It makes the following power supply parameters available via Modbus RTU on an RS485 or RS232 link, via Modbus TCP and HTTP over Ethernet.

- Output Voltage
- Battery Current
- Power Supply Current
- Battery Temperature
- Digital Indications for the following:
  - o Normal Operation
  - o Battery Presence
  - o Battery Condition
  - o Battery Condition Testing Status
  - o Battery Charging
  - o Battery Discharging
  - o Battery Condition Test Enable Status
  - o Mains Failure
  - o Overload
  - o System Down
  - o Battery Low
- Digital Controls for the following:
  - o Battery Condition Test Start and Stop
  - o Battery Condition Test Enable and Disable
- Optionally 4 digital inputs can be monitored and 2 relay outputs controlled

It provides a 10Mbps half-duplex connection.

Serial Modbus RTU can be configured with baud rates from 9600 up to 115200, with parities of none, odd, even, mark and space, 8 data bits and one stop bits

The converter can be interrogated via a web page to provide any of the parameters above.

## DEVICE SCHEMATIC AND IO CONNECTIONS

### CONNECTIONS:

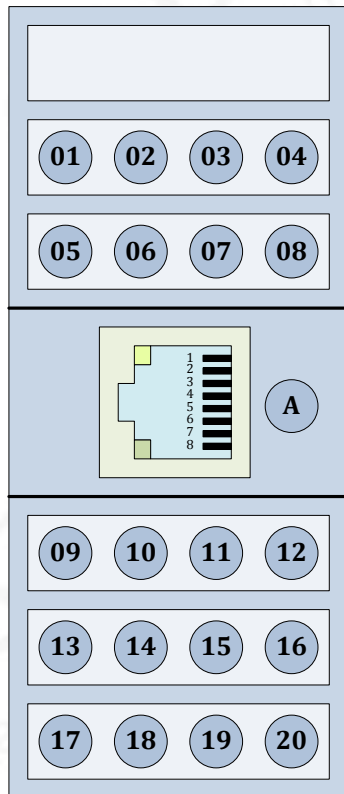

01. Modbus RS232 TX
02. Modbus RS232 RX
03. Modbus RS232 Common
04. Relay Outputs Common
05. Modbus RS485 D-
06. Modbus RS485 D+
07. Relay Output 1 (Optional)
08. Relay Output 2 (Optional)
A. Ethernet Port
09. Input 2 (Optional)
10. Input 1 (Optional)
11. Power Supply RS485 D+
12. Power Supply RS485 D-
13. Inputs Common
14. Unused
15. Unused
16. Unused
17. Input 4 (Optional)
18. Input 3 (Optional)
19. Power AC/DC
20. Power AC/DC

### WIRING DIAGRAMS

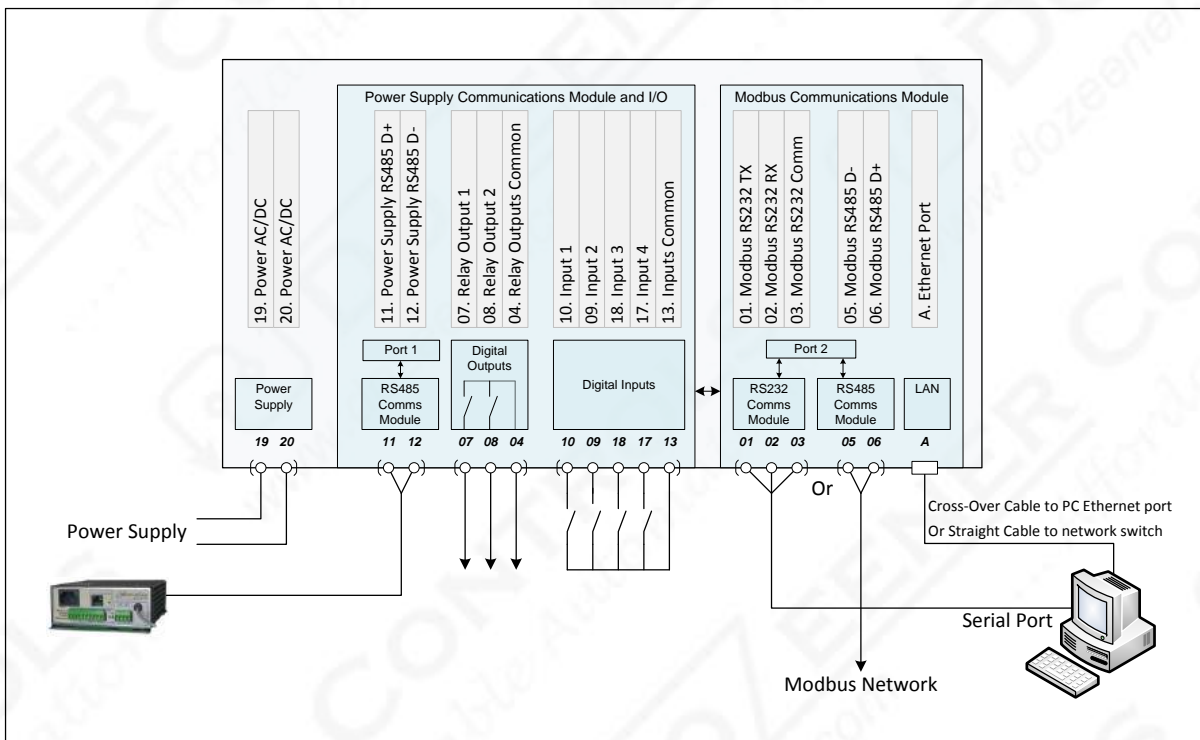

## SERIAL PROGRAMMING CABLE

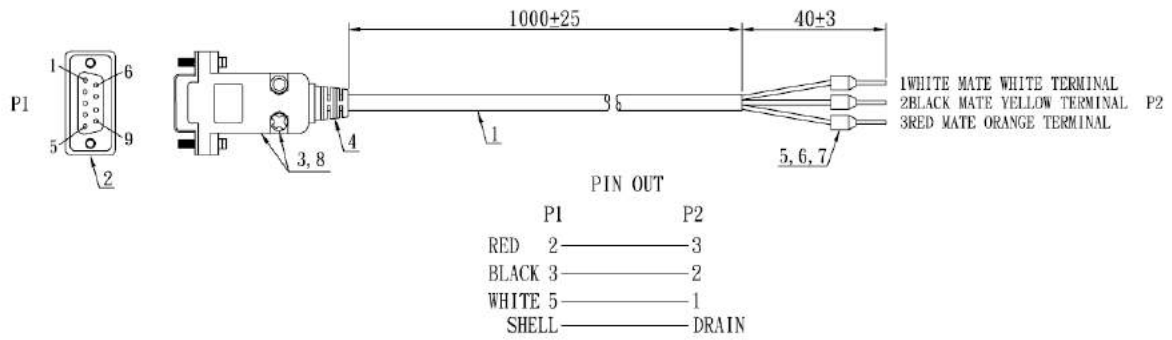

### Connections to protocol Converter

- White – Common
- Black – RX
- Red – TX



## FRONT PANEL INDICATIONS

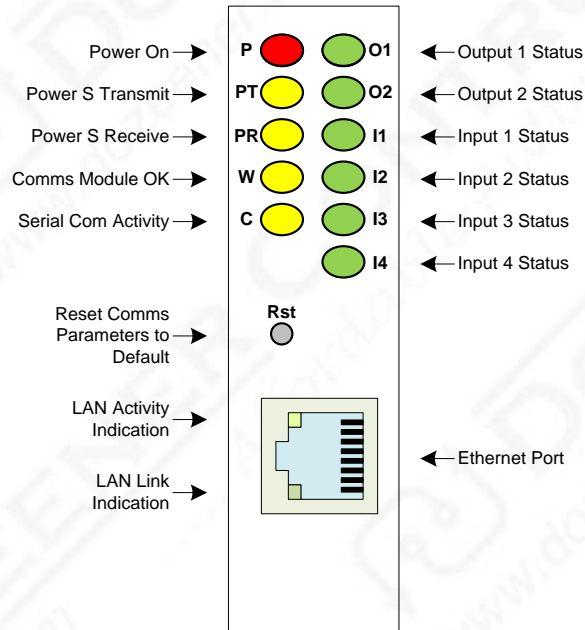

**P:** Power On: Solid RED when Power is available to the unit

**PT:** Power Supply Transmit: Flashes when a packet is sent to the power supply RS485 Port

**PR:** Power Supply Receive: Flashes when a packet is successfully received from the power supply RS485 Port

**W:** Communication Port Watchdog. The LED flashes yellow every second when the Modbus RTU, Modbus TCP and HTTP communications module is healthy

**C:** Communications activity on the Modbus RTU serial communication port. Flashed yellow every time a Modbus packet is transmitted in reply to a request from the serial Modbus RTU network.

**LAN Link:** Solid green when a link to the network has been established

**LAN Activity:** Flashes yellow when there is communications activity on the LAN

**O1-O2:** Output 1/2 Status indication. Solid green when output relay is ON

**I1-I4:** Input 1-4 status indication. Solid green when input is ON

### Color Coding:

Red: Power ON Indication

Yellow: Communications and Watchdog Indications

Green: Inputs and Outputs status indication

## DEVICE SETUP

### PROGRAMMING SOFTWARE

The DZC-eProtoCon-IE1 module is configured using the 'Power EtherMBLink' Software. This software package is supplied for free with the device. Further details on the software are provided later on in this manual.

### RESETTING TO DEFAULT COMMUNICATION SETTINGS

To Reset to default communication settings the 'Rst' button on the front of the device has to be pressed for 5 seconds while the Ethernet Protocol Converter is being powered up.

The default parameters are as follows:

#### **General Parameters**

Modbus Address: 1

#### **Serial Communications:**

Baud Rate: 9600

Parity: None

Data Bits: 8

Stop Bits: 1

#### **Ethernet Communications:**

IP Address: 192.168.8.60

Gateway Address: 192.168.8.255

Subnet Mask: 255.255.255.0

## SPECIFICATIONS

### ELECTRICAL

- Power Supply: Model 1: 9-15V.
- Digital Inputs: Volt Free Contact inputs with no isolation (Maximum of 4 Inputs)
- Digital Outputs: Relay Outputs max 2A at 30VDC (Maximum of 2 Outputs)

### COMMUNICATIONS

- Ethernet Port Speed: 10Mbps Half Duplex, IPv4
- Power Supply Communication Port: RS485 with no isolation
- Modbus Serial Communication Port: RS485 with no isolation, RS232 with no isolation or flow control.

### PROTOCOLS

- Modbus RTU Functions 1, 3, 5, 6, 15, 16
- Modbus TCP Functions 1, 3, 5, 6, 15, 16
- Internet Protocol: HTTP
- Internet Protocol: ARP/ICMPv4/TCP



## MODBUS RTU AND MODBUS TCP PROTOCOLS

The Maximum polling values for Modbus RTU and Modbus TCP are the following:

Maximum number of registers that can be polled using function 3: **20**

Maximum number of coils that can be polled using function 1: **32**

Maximum number of registers that can be written using function 16: **20**

Maximum number of coils that can be written using function 15: **8**

It is recommended that the device polling rate is not made faster than 500ms.

Polling via Ethernet can be done every 10ms but is not recommended as it overloads the communications network and may result in occasional failures when polling via HTTP

Polling via serial RS232 or RS485 can be done every 100ms but may result in a failure rate of 1% or less.

### READ ONLY REGISTERS

Register Name	Modbus Address	Description	Type
Vout	40002	Output Voltage	Register
Ibat	40004	Battery Current	Register
Ipsu	40006	Power Supply Current	Register
Temp	40008	Temperature	Register
BatDetect	40010	Time in minutes between battery detect tests (in mins)	Register
Vpres	40012	Minimum voltage to detect battery presence (in Volts)	Register
Vshutd	40014	Shutdown Voltage (in Volts)	Register
Vbatl	40016	Battery low alarm voltage level (in Volts)	Register
Vdisco	40018	Battery disconnect voltage (in Volts)	Register
Bccl	40020	Battery charge current limit (in %)	Register
BCTim	40022	Length of battery condition test (in mins)	Register
CC Mins	40024	Time interval between BCTs (in mins)	Register
CC Hrs	40026	Time interval between BCTs (in hours)	Register
CC Days	40028	Time interval between BCTs (in days)	Register
MfiBCT	40030	Mains fail check interval during BCT (in mins)	Register
NA	40036	Watchdog	Register

**All Values are scaled 1:10, i.e. a value of 123 is equivalent to 12.3**

**The values are stored in 16 bit unsigned registers.**

POWER SUPPLY READ ONLY COILS (NEW REGISTER SET)

Modbus Address	Description	Type	Read/Write
BCT Related Digitals			
00040	BCT Active	Bit	R
00041	BCT Status(Enabled/Disabled)	Bit	R
00042	BCT Start (Acknowledge)	Bit	R
00043	BCT Stop (Acknowledge)	Bit	R
00044	BCT Enable (Acknowledge)	Bit	R
00045	BCT Disable (Acknowledge)	Bit	R
Information Digitals			
00046	Charge Cycle (Normal Operation)	Bit	R
00047	Battery Ok	Bit	R
00048	Battery Present	Bit	R
00049	Battery Possibly Missing	Bit	R
00050	Possible Mains Fail (Brown Out)	Bit	R
00051	Battery Sign (Set for Negative/Discharge)	Bit	R
00052	Temperature Sign (Set for Negative)	Bit	R
00053	Retry Battery Test on Fail	Bit	R
Alarm Digitals			
00054	Battery Bad	Bit	R
00055	Battery Missing	Bit	R
00056	Overload	Bit	R
00057	Communications Fail to Power Supply	Bit	R
00058	System Down	Bit	R
00059	Battery Low	Bit	R
00060	Mains Failure	Bit	R

## POWER SUPPLY READ ONLY COILS (OLD REGISTER SET)

The following registers have been replaced with the ones in section 'POWER SUPPLY READ ONLY COILS (NEW REGISTER SET)'. The digital values in this section provide the same information as the revised ones but have a different interpretation.

It is recommended that these registers are not used for new applications. They are included in this manual for backward compatibility with older devices.

Register Name	Modbus Address	Description	Type
CC	00001	Charge Cycle (Normal Operation)	Bit
OL	00002	Overload	Bit
MF	00003	Mains Failure	Bit
BCT	00004	Battery Condition Test	Bit
BP	00005	Battery Present	Bit
BM	00006	Battery Missing	Bit
BL	00007	Battery Low	Bit
BB	00008	Battery Bad	Bit
M?	00009	Power Supply or Mains Failed (Brown Out)	Bit
B?	00010	Possibly Battery Missing	Bit
SD	00011	System Down	Bit
BO	00012	Battery OK during mains/psu fail	Bit
Bcond	00013	Battery Condition Test Enabled	Bit
Ret	00014	Retry Battery Test on Fail	Bit
TempSign	00015	Temperature Sign (1 = Negative, 0 = Positive)	Bit
BatSign	00016	Battery Current Sign (1 = Out, = 0 In)	Bit
BCT Start	00017	Battery Condition Test Started	Bit
BCT Stop	00018	Battery Condition Test Stopped	Bit
BCT Enable	00019	Battery Condition Test Enabled	Bit
BCT Disable	00020	Battery Condition Test Disabled	Bit
CommsF	00021	Communications Failure to Power Supply	Bit
b?	00022	Possibly Battery Missing (Battery Bad)	Bit
bM	00023	Battery Missing (Battery Bad)	Bit
bO	00024	Battery OK during mains/psu fail (Battery Bad)	Bit
bL	00025	Battery Low (Battery Bad)	Bit
bP	00026	Battery Present (Battery Bad)	Bit

## DIGITAL I/O READ ONLY COILS

Register Name	Modbus Address	Description	Type
MonDO1	00027	Monitoring of Digital Output 1 (Optional)	Bit
MonDO2	00028	Monitoring of Digital Output 2 (Optional)	Bit
MonDI1	00029	Monitoring of Digital Input 1 (Optional)	Bit
MonDI2	00030	Monitoring of Digital Input 2 (Optional)	Bit
MonDI3	00031	Monitoring of Digital Input 3 (Optional)	Bit
MonDI4	00032	Monitoring of Digital Input 4 (Optional)	Bit

## READ/WRITE COILS

Register Name	Modbus Address	Description	Type
BCTStart	00161	Start Battery Condition Test	Bit
BCTStop	00162	Stop Battery Condition Test	Bit
BCTEnable	00163	Enable Battery Condition Test	Bit
BCTDisable	00164	Disable Battery Condition Test	Bit
CntDO1	00165	Control of Digital Output 1 (Optional)	Bit
CntDO2	00166	Control of Digital Output 2 (Optional)	Bit

**Once the bit commands are sent to the device they are automatically reset to 0 by the protocol converter.**



## SNMP

### MANAGEMENT INFORMATION BASE (MIB) FILE

The picture on the right shows a graphical representation of the MIB file configuration for the device.

This part of the tree structure in the MIB File can be found under iso(1).org(3).dod(6).internet(1).private(4).enterprises(1) in the standard - RFC1155 "Structure and Identification of Management Information for TCP/IP based internets"

It is divided into the following sections:

#### DEVICE IDENTIFICATION (OID 1.3.6.1.4.1.38586.1.1)

This set of information consists of information related to the device being monitored. They are all string objects and are fixed for a particular unit.

#### READINGS (OID 1.3.6.1.4.1.38586.1.2)

These variables are all integers. For voltages and currents, instead of values being in Volts and Amps, they are represented in mVolts and mAmps. the reason for this is that SNMP cannot display floating point numbers. the Network Management Software can then divide these numbers by 1000 to display the required values.

#### INFORMATION DIGITALS (OID 1.3.6.1.4.1.38586.1.3)

All digital values are displayed as integers, 0 representing Off and 1 representing On. These are the power supply digital values displaying only information that are not deemed alarms.

#### ALARM DIGITALS (OID 1.3.6.1.4.1.38586.1.4)

Similar to information digitals, but for the power supply alarms. All digital alarms are also sent as traps.

#### CONTROL (OID 1.3.6.1.4.1.38586.1.5)

Control digitals are represented by integers. Setting any of these values to 1 will activate or deactivate the corresponding signal. These values do not need to be reset to 0. The correct read/write community string is required to control these values.

#### TRAPS (OID 1.3.6.1.4.1.38586.1.6)

These unsolicited messages will be sent to the network management software when these signals are activated. There will be no messages signals sent to the NMS when they are back to the Off state.

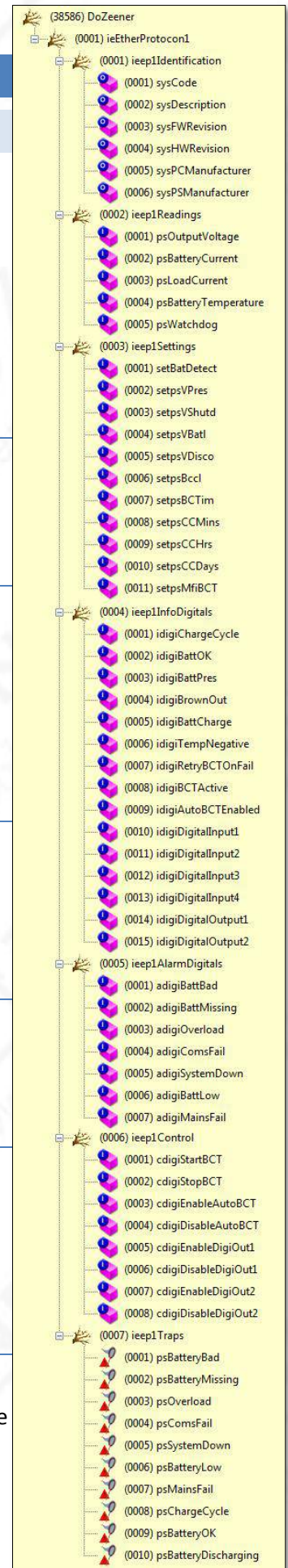

## SNMP PROTOCOL COMPATIBILITY

This implementation of the SNMP Protocol supports the following functions:

- GET
- SET
- TRAPS
- GETNEXT (SNMP Walk)

The following settings are user configurable:

- Read Only Community Key
- Read/Write Community Key
- Protocol Port
- Enabling/Disabling of sending of Traps
- Network Management Software (NMS) IP address for Traps

The MIB file is included as part of the EtherMBLink Installation CD.

## SOFTWARE

All the SNMP parameters can be programmed using the Power EtherMBLink Software.

Below is a screenshot of the section in the 'Communication Settings' Tab in the software

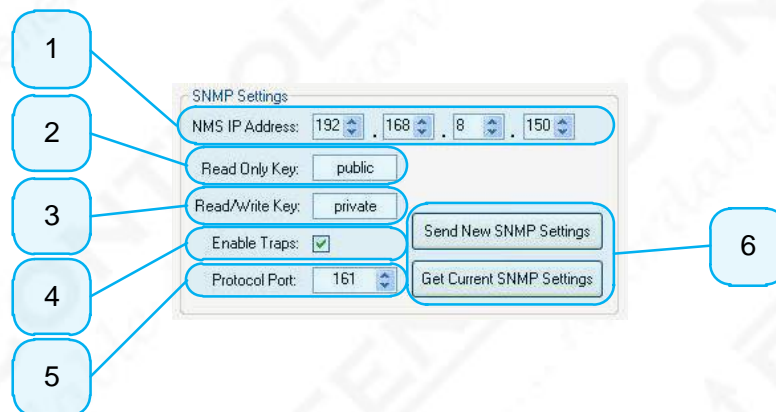

1. Network Manager Software (NMS) IP Address. This is the IP Address where all the traps will be sent to. The NMS software should be configured to accept unsolicited messages from this SNMP Agent.
2. The read-only community string should be programmed to match the community string programmed in the NMS.
3. Similar to the Read Only String, the Read/Write String is used for writing information to the SNMP Agent. In this implementation it is required for all the items in the section 'ieep1Control' – OID Number 1.3.6.1.4.1.38586.1.5
4. Checking this box will enable sending of Traps. Unsolicited messages will be sent to the NMS only if this feature is enabled. Port 162 will be used for sending of traps on the IP address in 'item' 1.
5. The SNMP agent can be interrogated for information on the default standard port of 161, or otherwise this can be changed to a more 'secure' port.
6. These buttons will either write the information in this section to the device attached via the serial port or read the values from it.



## SNMP WALK TEST

The EtherMBLink software installation CD contains a copy of SNMPWalk.exe, which is a small program which can be used to do an SNMP Walk test on the SNMP Agent.

The following is a screenshot with an example polling an SNMP agent with address 192.168.8.60, and an SNMP walk starting from OID 1.3.6.1.4.1. The result is a list of all the parameters which can be monitored from the Innovative Energies Power Supply. This list excludes all control digitals and traps.

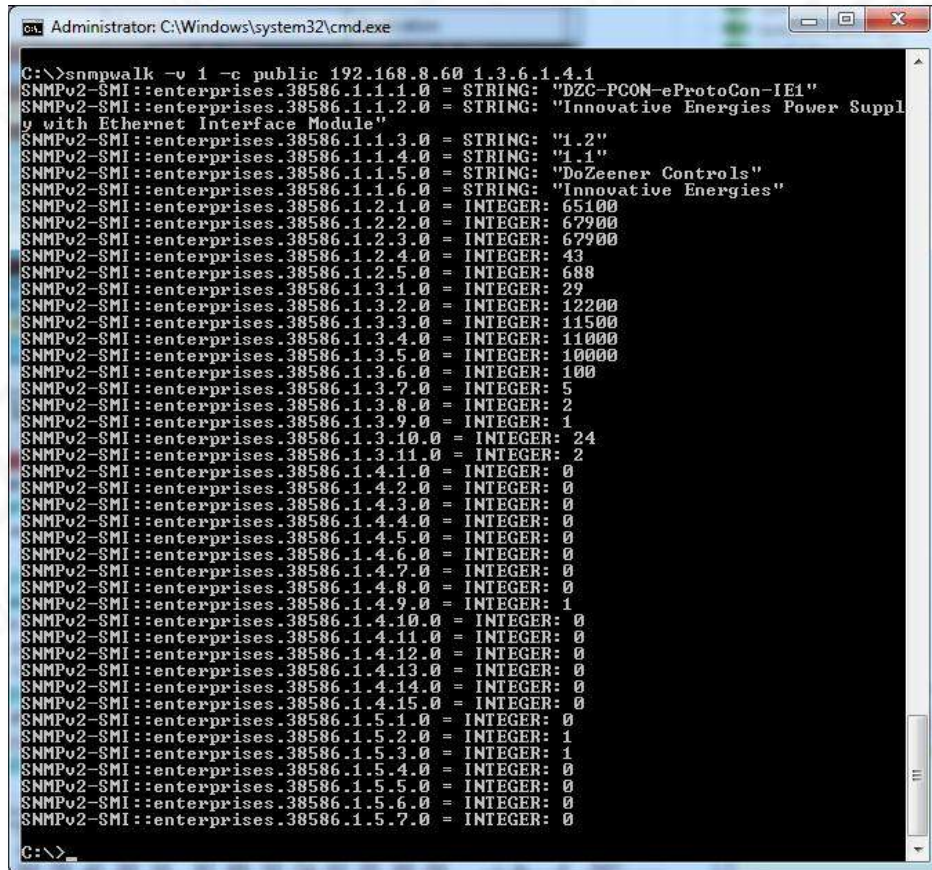

```
Administrator: C:\Windows\system32\cmd.exe
C:\>snmpwalk -v 1 -c public 192.168.8.60 1.3.6.1.4.1
SNMPv2-SMI::enterprises.38586.1.1.1.0 = STRING: "DZC-PCON-eProtoCon-IE1"
SNMPv2-SMI::enterprises.38586.1.1.2.0 = STRING: "Innovative Energies Power Supply with Ethernet Interface Module"
SNMPv2-SMI::enterprises.38586.1.1.3.0 = STRING: "1.2"
SNMPv2-SMI::enterprises.38586.1.1.4.0 = STRING: "1.1"
SNMPv2-SMI::enterprises.38586.1.1.5.0 = STRING: "DoZeener Controls"
SNMPv2-SMI::enterprises.38586.1.1.6.0 = STRING: "Innovative Energies"
SNMPv2-SMI::enterprises.38586.1.2.1.0 = INTEGER: 65100
SNMPv2-SMI::enterprises.38586.1.2.2.0 = INTEGER: 67900
SNMPv2-SMI::enterprises.38586.1.2.3.0 = INTEGER: 67900
SNMPv2-SMI::enterprises.38586.1.2.4.0 = INTEGER: 43
SNMPv2-SMI::enterprises.38586.1.2.5.0 = INTEGER: 688
SNMPv2-SMI::enterprises.38586.1.3.1.0 = INTEGER: 29
SNMPv2-SMI::enterprises.38586.1.3.2.0 = INTEGER: 12200
SNMPv2-SMI::enterprises.38586.1.3.3.0 = INTEGER: 11500
SNMPv2-SMI::enterprises.38586.1.3.4.0 = INTEGER: 11000
SNMPv2-SMI::enterprises.38586.1.3.5.0 = INTEGER: 10000
SNMPv2-SMI::enterprises.38586.1.3.6.0 = INTEGER: 100
SNMPv2-SMI::enterprises.38586.1.3.7.0 = INTEGER: 5
SNMPv2-SMI::enterprises.38586.1.3.8.0 = INTEGER: 2
SNMPv2-SMI::enterprises.38586.1.3.9.0 = INTEGER: 1
SNMPv2-SMI::enterprises.38586.1.3.10.0 = INTEGER: 24
SNMPv2-SMI::enterprises.38586.1.3.11.0 = INTEGER: 2
SNMPv2-SMI::enterprises.38586.1.4.1.0 = INTEGER: 0
SNMPv2-SMI::enterprises.38586.1.4.2.0 = INTEGER: 0
SNMPv2-SMI::enterprises.38586.1.4.3.0 = INTEGER: 0
SNMPv2-SMI::enterprises.38586.1.4.4.0 = INTEGER: 0
SNMPv2-SMI::enterprises.38586.1.4.5.0 = INTEGER: 0
SNMPv2-SMI::enterprises.38586.1.4.6.0 = INTEGER: 0
SNMPv2-SMI::enterprises.38586.1.4.7.0 = INTEGER: 0
SNMPv2-SMI::enterprises.38586.1.4.8.0 = INTEGER: 0
SNMPv2-SMI::enterprises.38586.1.4.9.0 = INTEGER: 1
SNMPv2-SMI::enterprises.38586.1.4.10.0 = INTEGER: 0
SNMPv2-SMI::enterprises.38586.1.4.11.0 = INTEGER: 0
SNMPv2-SMI::enterprises.38586.1.4.12.0 = INTEGER: 0
SNMPv2-SMI::enterprises.38586.1.4.13.0 = INTEGER: 0
SNMPv2-SMI::enterprises.38586.1.4.14.0 = INTEGER: 0
SNMPv2-SMI::enterprises.38586.1.4.15.0 = INTEGER: 0
SNMPv2-SMI::enterprises.38586.1.5.1.0 = INTEGER: 0
SNMPv2-SMI::enterprises.38586.1.5.2.0 = INTEGER: 1
SNMPv2-SMI::enterprises.38586.1.5.3.0 = INTEGER: 1
SNMPv2-SMI::enterprises.38586.1.5.4.0 = INTEGER: 0
SNMPv2-SMI::enterprises.38586.1.5.5.0 = INTEGER: 0
SNMPv2-SMI::enterprises.38586.1.5.6.0 = INTEGER: 0
SNMPv2-SMI::enterprises.38586.1.5.7.0 = INTEGER: 0
C:\>
```

## OID DESCRIPTIONS

### OBJECTS

OID Name	OID Number	Type	R/RW	Long Description	Units	Comment
DoZeener	1.3.6.1.4.1.38555					
ieEtherProtocon1	1.3.6.1.4.1.38555.1					
ieep1Identification	1.3.6.1.4.1.38555.1.1					
sysCode	1.3.6.1.4.1.38555.1.1.1	String	R	Device Code	NA	
sysDescription	1.3.6.1.4.1.38555.1.1.2	String	R	Device Description	NA	
sysFWRevision	1.3.6.1.4.1.38555.1.1.3	String	R	Device Firmware Revision	NA	
sysHWRevision	1.3.6.1.4.1.38555.1.1.4	String	R	Device Hardware Revision	NA	
sysPCManufacturer	1.3.6.1.4.1.38555.1.1.5	String	R	Protocol Converter Manufacturer	NA	
sysPSManufacturer	1.3.6.1.4.1.38555.1.1.6	String	R	Power Supply Manufacturer	NA	
ieep1Readings	1.3.6.1.4.1.38555.1.2					
psOutputVoltage	1.3.6.1.4.1.38555.1.2.1	Integer	R	Output Voltage (in mV)	mV	
psBatteryCurrent	1.3.6.1.4.1.38555.1.2.2	Integer	R	Battery Current (in mA)	mA	
psLoadCurrent	1.3.6.1.4.1.38555.1.2.3	Integer	R	Load Current (in mA)	mA	
psBatteryTemperature	1.3.6.1.4.1.38555.1.2.4	Integer	R	Battery Temperature (in DegC)	DegC	
psWatchdog	1.3.6.1.4.1.38555.1.2.5	Integer	R	Watchdog Counter	NA	
ieep1Settings	1.3.6.1.4.1.38555.1.3					
setBatDetect	1.3.6.1.4.1.38555.1.3.1	Integer	R	Time in minutes between battery detect tests (in mins)	mins	
setpsVPres	1.3.6.1.4.1.38555.1.3.2	Integer	R	Minimum voltage to detect battery presence (in Milli Volts)	mV	
setpsVShutd	1.3.6.1.4.1.38555.1.3.3	Integer	R	Shutdown Voltage (in Milli Volts)	mV	
setpsVBatl	1.3.6.1.4.1.38555.1.3.4	Integer	R	Battery low alarm voltage level (in Milli Volts)	mV	
setpsVDisco	1.3.6.1.4.1.38555.1.3.5	Integer	R	Battery disconnect voltage (in Milli Volts)	mV	
setpsBccl	1.3.6.1.4.1.38555.1.3.6	Integer	R	Battery charge current limit (in %)	mV	
setpsBCTim	1.3.6.1.4.1.38555.1.3.7	Integer	R	Length of battery condition test (in mins)	%	
setpsCCMins	1.3.6.1.4.1.38555.1.3.8	Integer	R	Time interval between BCTs (in mins)	mins	
setpsCCHrs	1.3.6.1.4.1.38555.1.3.9	Integer	R	Time interval between BCTs (in hours)	hrs	
setpsCCDays	1.3.6.1.4.1.38555.1.3.10	Integer	R	Time interval between BCTs (in days)	days	
setpsMfiBCT	1.3.6.1.4.1.38555.1.3.11	Integer	R	Mains fail check interval during BCT (in mins)	mins	

OID Name	OID Number	Type	R/RW	Long Description	Units	Comment
ieep1InfoDigitals	1.3.6.1.4.1.38555.1.4					
idigiChargeCycle	1.3.6.1.4.1.38555.1.4.1	Integer	R	Charge Cycle (Normal Operation)	NA	0 = Off, 1 = ON
idigiBattOK	1.3.6.1.4.1.38555.1.4.2	Integer	R	Battery Ok	NA	0 = Off, 1 = ON
idigiBattPres	1.3.6.1.4.1.38555.1.4.3	Integer	R	Battery Present	NA	0 = Off, 1 = ON
idigiBrownOut	1.3.6.1.4.1.38555.1.4.4	Integer	R	Possible Mains Fail (Brown Out)	NA	0 = Off, 1 = ON
idigiBattCharge	1.3.6.1.4.1.38555.1.4.5	Integer	R	Battery Sign (Set for Negative/Discharge)	NA	0 = Off, 1 = ON
idigiTempNegative	1.3.6.1.4.1.38555.1.4.6	Integer	R	Temperature Sign (Set for Negative)	NA	0 = Off, 1 = ON
idigiRetryBCTOnFail	1.3.6.1.4.1.38555.1.4.7	Integer	R	Retry Battery Test on Fail	NA	0 = Off, 1 = ON
idigiBCTActive	1.3.6.1.4.1.38555.1.4.8	Integer	R	Battery Condition Testing Active	NA	0 = Off, 1 = ON
idigiAutoBCTEnabled	1.3.6.1.4.1.38555.1.4.9	Integer	R	Automatic Battery Condition Testing Enabled	NA	0 = Off, 1 = ON
idigiDigitalInput1	1.3.6.1.4.1.38555.1.4.10	Integer	R	Digital Input 1 State	NA	0 = Off, 1 = ON
idigiDigitalInput2	1.3.6.1.4.1.38555.1.4.11	Integer	R	Digital Input 2 State	NA	0 = Off, 1 = ON
idigiDigitalInput3	1.3.6.1.4.1.38555.1.4.12	Integer	R	Digital Input 3 State	NA	0 = Off, 1 = ON
idigiDigitalInput4	1.3.6.1.4.1.38555.1.4.13	Integer	R	Digital Input 4 State	NA	0 = Off, 1 = ON
idigiDigitalOutput1	1.3.6.1.4.1.38555.1.4.14	Integer	R	Digital Output 1 State	NA	0 = Off, 1 = ON
idigiDigitalOutput2	1.3.6.1.4.1.38555.1.4.15	Integer	R	Digital Output 2 State	NA	0 = Off, 1 = ON
ieep1AlarmDigitals	1.3.6.1.4.1.38555.1.5					
adigiBattBad	1.3.6.1.4.1.38555.1.5.1	Integer	R	Battery Bad	NA	0=Normal, 1=Alarm
adigiBattMissing	1.3.6.1.4.1.38555.1.5.2	Integer	R	Battery Missing	NA	0=Normal, 1=Alarm
adigiOverload	1.3.6.1.4.1.38555.1.5.3	Integer	R	Overload	NA	0=Normal, 1=Alarm
adigiComsFail	1.3.6.1.4.1.38555.1.5.4	Integer	R	Communications Fail to Power Supply	NA	0=Normal, 1=Alarm
adigiSystemDown	1.3.6.1.4.1.38555.1.5.5	Integer	R	System Down	NA	0=Normal, 1=Alarm
adigiBattLow	1.3.6.1.4.1.38555.1.5.6	Integer	R	Battery Low	NA	0=Normal, 1=Alarm
adigiMainsFail	1.3.6.1.4.1.38555.1.5.7	Integer	R	Mains Failure	NA	0=Normal, 1=Alarm
ieep1Control	1.3.6.1.4.1.38555.1.6					
cdigiStartBCT	1.3.6.1.4.1.38555.1.6.1	Integer	RW	Start Battery Condition Test	NA	1=Set (Auto Reset)
cdigiStopBCT	1.3.6.1.4.1.38555.1.6.2	Integer	RW	Stop Battery Condition Test	NA	1=Set (Auto Reset)
cdigiEnableAutoBCT	1.3.6.1.4.1.38555.1.6.3	Integer	RW	Enable Battery Condition Test	NA	1=Set (Auto Reset)
cdigiDisableAutoBCT	1.3.6.1.4.1.38555.1.6.4	Integer	RW	Disable Battery Condition Test	NA	1=Set (Auto Reset)
cdigiEnableDigiOut1	1.3.6.1.4.1.38555.1.6.5	Integer	RW	Switch On Digital Output 1	NA	1=Set (Auto Reset)
cdigiDisableDigiOut1	1.3.6.1.4.1.38555.1.6.6	Integer	RW	Switch Off Digital Output 1	NA	1=Set (Auto Reset)
cdigiEnableDigiOut2	1.3.6.1.4.1.38555.1.6.7	Integer	RW	Switch On Digital Output 2	NA	1=Set (Auto Reset)
cdigiDisableDigiOut2	1.3.6.1.4.1.38555.1.6.8	Integer	RW	Switch Off Digital Output 2	NA	1=Set (Auto Reset)

## TRAPS

ieep1Traps		
OID Name	OID Number	Long Description
	1.3.6.1.4.1.38555.1.7	
psBatteryBad	1.3.6.1.4.1.38555.1	Battery Bad
psBatteryMissing	1.3.6.1.4.1.38555.2	Battery Missing
psOverload	1.3.6.1.4.1.38555.3	Overload
psComsFail	1.3.6.1.4.1.38555.4	Communications Fail to Power Supply
psSystemDown	1.3.6.1.4.1.38555.5	System Down
psBatteryLow	1.3.6.1.4.1.38555.6	Battery Low
psMainsFail	1.3.6.1.4.1.38555.7	Mains Failure
psChargeCycle	1.3.6.1.4.1.38555.8	Charge Cycle (Normal Operation)
psBatteryOK	1.3.6.1.4.1.38555.9	Battery Present
psBatteryDischarging	1.3.6.1.4.1.38555.10	Battery Sign (Set for Negative/Discharge)



### INTRODUCTION

A web page can be used to access registers using the popular HTML language. The HTML Ethernet interface is compatible with version 1.1. The interface has been tested with the following popular web browsers:

- Internet Explorer 7.0 and 8.0
- Mozilla Firefox 3.5
- Opera 9.0 to 10.5
- Sea Monkey 2.0
- Google Chrome 4.1

It should be compatible with other browsers, but has never been tested.

Registers can be accessed individually by calling .htm pages as indicated in the tables below.

As an example requesting web page <http://192.168.8.60/MA01A001.htm> will return the following information from the device with IP Address 192.168.8.60

- 32 bit value 1. This is equivalent to Modbus Registers 40001 and 40002
- Detail to 1 decimal point
- Value automatic refresh is disabled

The tables below show the deconstruction of the htm address.

## HTML STRING DECONSTRUCTION - MONITORING OF AN ANALOGUE VALUE

### BYTES

1	2	3	4	5	6	7	8
M (Monitor)	A (Analogue)	0 (Reserved)	0 (Decimals)	A (Refresh Rate)	0 (Num)	0 (Num)	0 (Num)
9	10	11	12				
.	h	t	m				

### BYTES DESCRIPTIONS

Character	Possible Values	Description
1	M	Monitoring
2	A	Analogue Values
3	0 to 9	<i>Reserved Byte</i>
4	0 to 3	Number of digits after decimal point (Above 3 = Auto)
5	A	No Refresh
	B	Refresh Every 1 Sec
	C	Refresh Every 2 Sec
	D	Refresh Every 5 Sec
	E	Refresh Every 10 Sec
	F	Refresh Every 15 Sec
	G	Refresh Every 30 Sec
	H	Refresh Every 60 Sec
	I	Refresh Every 120 Sec
	J	Refresh Every 300 Sec
	K	Refresh Every 600 Sec
6	0 to 9	Variable Number to Monitor - Hundreds
7	0 to 9	Variable Number to Monitor - Tens
8	0 to 9	Variable Number to Monitor - Units
9	.	The last four digits should always be ".htm"
10	h	
11	t	
12	m	

### HTML ADDRESS EXAMPLES

HTML Page	Description	Result Example
MA00A001.htm	Monitor Analogue Variable. No digits after decimal point will be displayed. The value will not automatically refresh. Value 001 will be monitored	4567
MA02B002.htm	Monitor Analogue Variable. Two digits after decimal point will be displayed. The value will automatically refresh after 1 second. Value 002 will be monitored	4567.89



## SCREENSHOT EXAMPLES

MA03A001.htm = Monitor Analogue, Display 3 Decimal Places, Auto Refresh Disabled, Value 1



MA01A001.htm = Monitor Analogue, Display 1 Decimal Place, Auto Refresh Disabled, Value 1

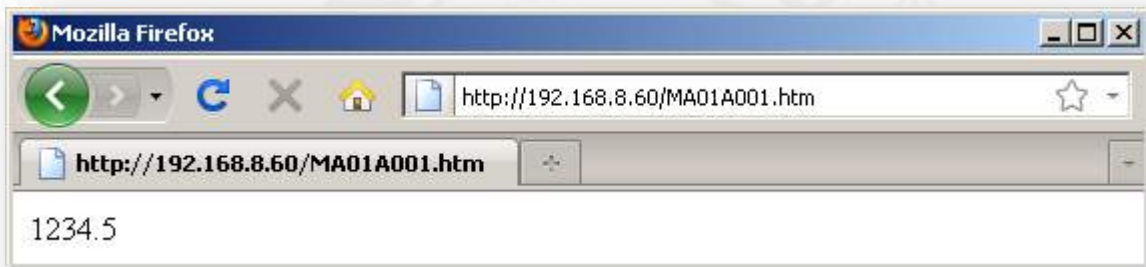

MA01D001.htm = Monitor Analogue, Display 1 Decimal Place, Refresh every 5 seconds, Value 1



MA02F123.htm = Monitor Analogue, Display 2 Decimal Places, Refresh every 15 seconds, Value 123

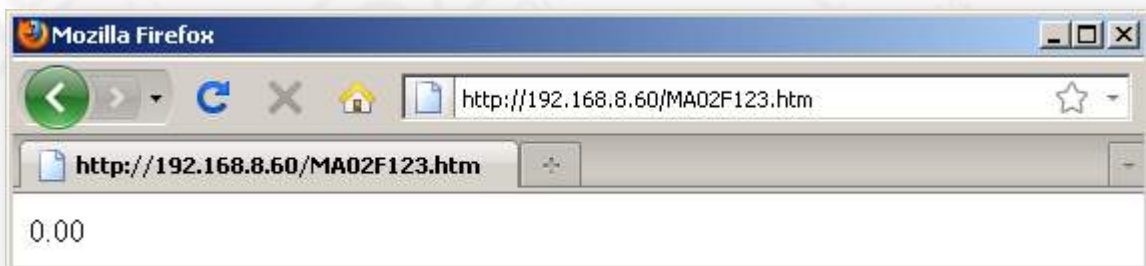

## HTML STRING DECONSTRUCTION - MONITORING OF A DIGITAL VALUE

1	2	3	4	5	6	7	8	
M (Monitor)	D (Digital)	A (Messages)	A (Logic)	A (Refresh Rate)	0 (Num)	0 (Num)	0 (Num)	
9	10	11	12					
.	h	t	m					
Character	Possible Values	Description						
1	M	Monitoring						
2	D	Digital Values						
3	A	On - "1", Off - "0"						
	B	On - "On", Off - "Off"						
	C	On - "Alarm", Off - "No Alarm"						
	D	On - "OK", Off - "NOK"						
	E	On - "Full", Off - "<Blank>"						
	F	On - "Empty", Off - "<Blank>"						
	G	On - "High", Off - "<Blank>"						
	H	On - "Low", Off - "<Blank>"						
	I	On - "Hi Hi", Off - "<Blank>"						
	J	On - "Hi", Off - "<Blank>"						
	K	On - "Lo", Off - "<Blank>"						
4	L	On - "Lo Lo", Off - "<Blank>"						
	A	Logic - Direct						
	B	Logic - Indirect						
	5	A	No Refresh					
		B	Refresh Every 1 Sec					
		C	Refresh Every 2 Sec					
		D	Refresh Every 5 Sec					
E		Refresh Every 10 Sec						
	F	Refresh Every 15 Sec						
	G	Refresh Every 30 Sec						
	H	Refresh Every 60 Sec						
	I	Refresh Every 120 Sec						
	J	Refresh Every 300 Sec						
	K	Refresh Every 600 Sec						
6	0 to 9	Variable Number to Monitor - Hundreds						
7	0 to 9	Variable Number to Monitor - Tens						
8	0 to 9	Variable Number to Monitor - Units						
9	.	The last four digits should always be ".htm"						
10	h							
11	t							
12	m							
Examples								
HTML Page		Description			Result Example			
MDCAD001.htm		Monitor Digital Variable 001. Will Display "Alarm" when On and "No Alarm" when Off. The value will automatically refresh every 5 seconds.			Alarm/No Alarm			
MDCBD001.htm		Monitor Digital Variable 001. Will Display "No Alarm" when On and "Alarm" when Off. The value will automatically refresh every 5 seconds.			No Alarm/Alarm			

## SCREENSHOT EXAMPLES

### Examples when the value of Coil 1 is Off:

Monitor Digital Value 1, Message On/Off, Direct Logic, Automatic Refresh Disabled



Monitor Digital Value 1, Message Alarm/No Alarm, Direct Logic, Automatic Refresh Disabled

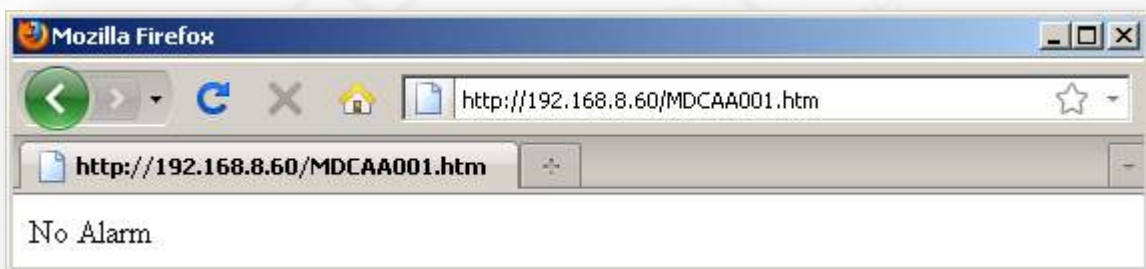

Monitor Digital Value 1, Message OK/NOK, Direct Logic, Automatic Refresh Disabled

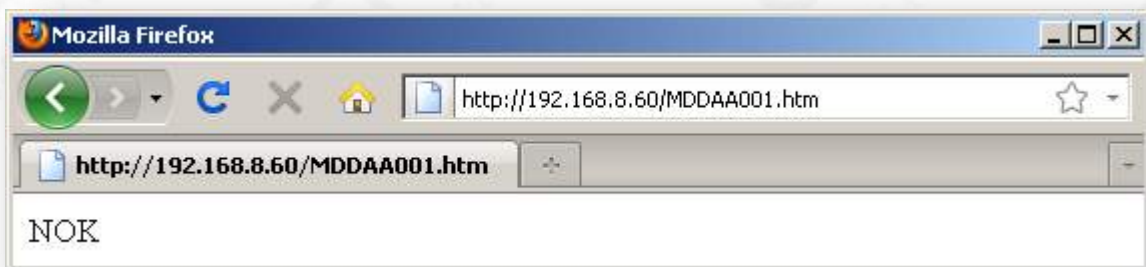

Monitor Digital Value 1, Message On/Off, Inverted Logic, Automatic Refresh Disabled



Monitor Digital Value 1, Message Full/<Blank>, Indirect Logic, Automatic Refresh every 30 Seconds



**Examples when the value of Coil 1 is On**

Monitor Digital Value 1, Message Alarm/No Alarm, Direct Logic, Automatic Refresh Disabled



Monitor Digital Value 1, Message High/<Blank>, Direct Logic, Automatic Refresh Disabled



Monitor Digital Value 1, Message LoLo/<Blank>, Direct Logic, Automatic Refresh Disabled





## HTML STRING DECONSTRUCTION - CONTROL OF AN ANALOGUE VALUE

<b>HTML Code Bytes - Call first Time</b>							
1	2	3	4	5	6	7	8
C (Control)	?	V	a	l	0 (Num)	0 (Num)	0 (Num)
9	10	11	12				
=	?	?	?				
Character	Possible Values	Description					
1	C	Control					
2	?	This value is static and cannot change					
3	V	This value is static and cannot change					
4	a	This value is static and cannot change					
5	l	This value is static and cannot change					
6	0 to 9	Variable Number to Monitor - Hundreds					
7	0 to 9	Variable Number to Monitor - Tens					
8	0 to 9	Variable Number to Monitor - Units					
9	=	This value is static and cannot change					
10	?	This value is static and cannot change					
11	?	This value is static and cannot change					
12	?	This value is static and cannot change					

<b>HTML Code Bytes - Setting a Positive Value</b>							
1	2	3	4	5	6	7	8
C (Control)	?	V	a	l	0 (Num)	0 (Num)	0 (Num)
9	10	10+n	10+n+1	10+n+2	10+n+3	10+n+3+m	10+n+3+m+1
=	0	.....n.....	0	.	0	.....m.....	0

<b>HTML Code Bytes - Setting a Negative Value</b>							
1	2	3	4	5	6	7	8
C (Control)	?	V	a	l	0 (Num)	0 (Num)	0 (Num)
9	10	11	11+n	11+n+1	11+n+2	11+n+3	11+n+3+m
=	-	0	.....n.....	0	.	0	.....m.....
11+n+3+m+1	Max Chars n = 7, Max Chars m = 3.						
0							

Character	Possible Values	Description
1	C	Control
2	?	This value is static and cannot change
3	V	This value is static and cannot change
4	a	This value is static and cannot change
5	l	This value is static and cannot change
6	0 to 9	Variable Number to Monitor - Hundreds
7	0 to 9	Variable Number to Monitor - Tens
8	0 to 9	Variable Number to Monitor - Units
9	=	Variable Number to Monitor - Units
10	0 to 9	Variable Number to Monitor - Units
10+n	.....n....	Variable Number to Monitor - Units
10+n+1	0 to 9	Variable Number to Monitor - Units
10+n+2	.	This value is static and cannot change
10+n+3	0 to 9	Variable Number to Monitor - Units
10+n+3+m	.....m....	Variable Number to Monitor - Units
10+n+3+m+1	0 to 9	Variable Number to Monitor - Units

**Examples**

HTML Page	Description	Result Example
C?Val001=???	Initial Call to set analogue value 1	User is asked to set a value
C?Val001=000.000	Command to set analogue value 1 to 0.0	Value is set and user is asked to set a value

#### SCREENSHOT EXAMPLES

Setting of Analogue Value 1:

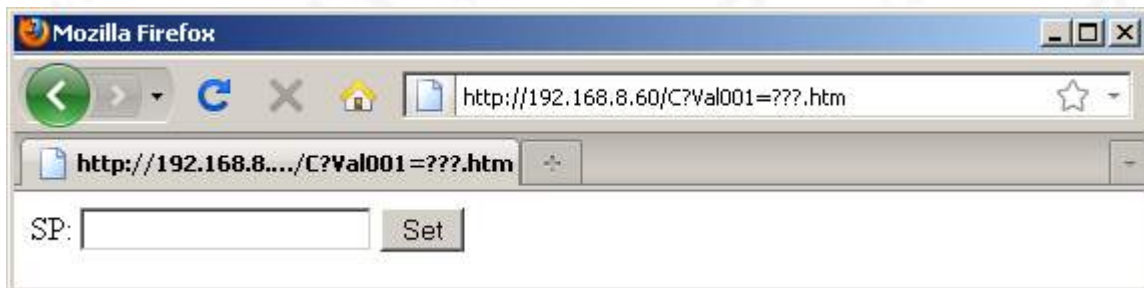

Setting of Analogue Value 151:

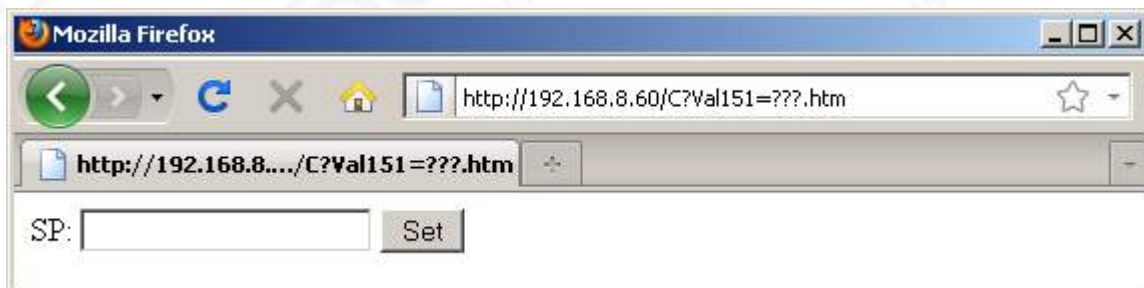



Setting of Analogue Value 151 – Inputting a value of 583.354:

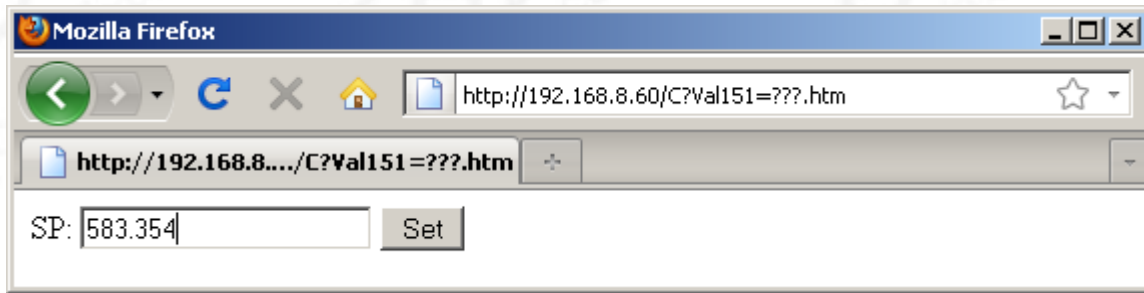

Result when pressing 'Set' Button

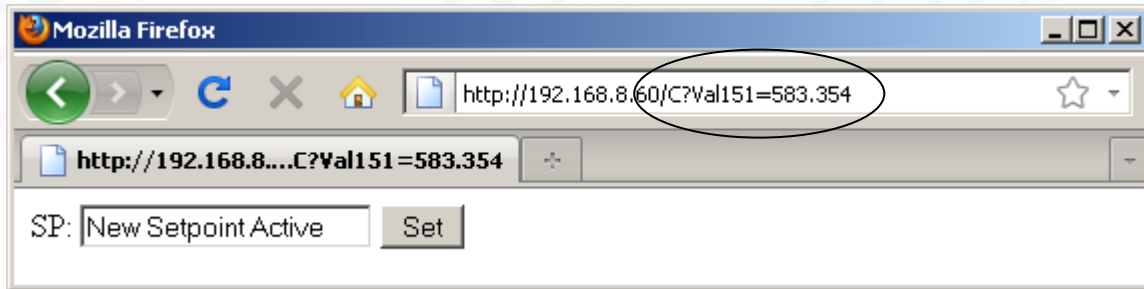

## HTML STRING DECONSTRUCTION - CONTROL OF A DIGITAL VALUE

HTML Code Bytes							
1	2	3	4	5	6	7	8
C (Control)	T (Toggle)	O	D	D (Digital)	0 (Num)	0 (Num)	0 (Num)
Character	Possible Values	Description					
6	C	Control					
7	T	Request to Toggle					
	S	Request to Switch					
8	O	Toggle: Can only be "O" for On/Off Switch: Can be "N" for oN, "F" for oF					
9	A	Action Only - No Display (Returns Blank Page)					
	B	Display and Action					
	D	Display Only - No Action					
10	D	Always D for Digital					
11	0 to 9	Variable Number to Monitor - Hundreds					
12	0 to 9	Variable Number to Monitor - Tens					
13	0 to 9	Variable Number to Monitor - Units					
14	.	The last four digits should always be ".htm"					
15	h						
16	t						
17	m						
Examples							
HTML Page		Description			Result Example		
CTODD001		Toggle Digital Value 001			None		
CSNDD001		Switch On Digital Value 001			None		
CSFDD001		Switch Off Digital Value 001			None		

### SCREENSHOT EXAMPLES

Setting of Digital Value 1 using a Toggle Button

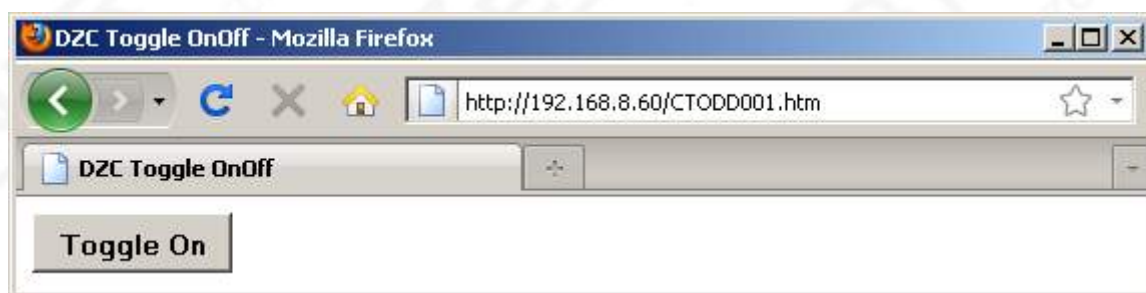

Result when Pressing the button:

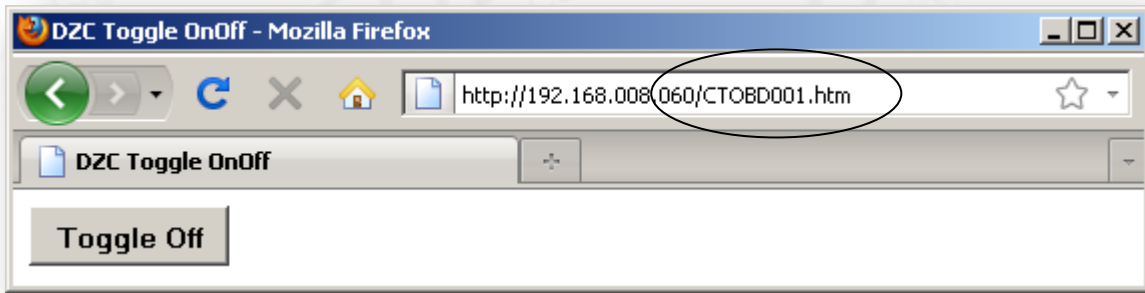

Setting of Digital Value 1 using a On Button



Setting of Digital Value 1 using a On Button



Setting of Digital Value 1 without using buttons – Command is send by there is no feedback:

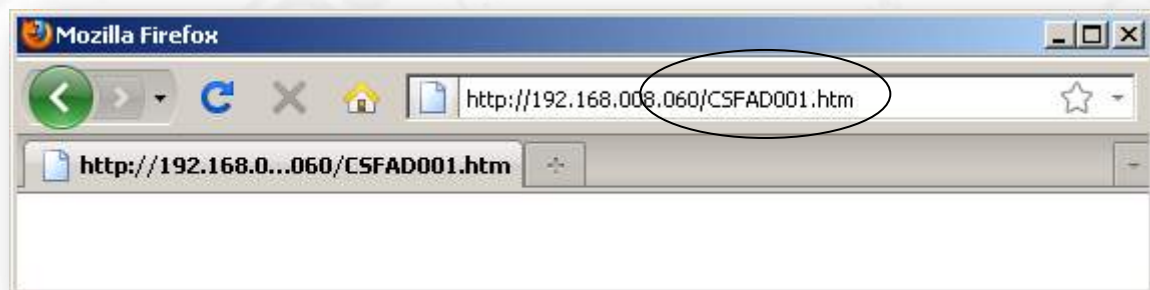

## POWER SUPPLY PARAMETERS IN HTML FORMAT:

### READ ONLY ANALOGUE PARAMETERS

Register Name	HTML Address	Description	Type
Vout	MA01F001.htm	Output Voltage	Register
Ibat	MA01F002.htm	Battery Current	Register
Ipsu	MA01F003.htm	Power Supply Current	Register
Temp	MA01F004.htm	Temperature	Register
BatDetect	MA01F005.htm	Time in minutes between battery detect tests (in mins)	Register
Vpres	MA01F006.htm	Minimum voltage to detect battery presence (in Volts)	Register
Vshutd	MA01F007.htm	Shutdown Voltage (in Volts)	Register
Vbatl	MA01F008.htm	Battery low alarm voltage level (in Volts)	Register
Vdisco	MA01F009.htm	Battery disconnect voltage (in Volts)	Register
Bccl	MA01F010.htm	Battery charge current limit (in %)	Register
BCTim	MA01F011.htm	Length of battery condition test (in mins)	Register
CC Mins	MA01F012.htm	Time interval between BCTs (in mins)	Register
CC Hrs	MA01F013.htm	Time interval between BCTs (in hours)	Register
CC Days	MA01F014.htm	Time interval between BCTs (in days)	Register
MfiBCT	MA01F015.htm	Mains fail check interval during BCT (in mins)	Register
NA	MA01F018.htm	Watchdog	Register

### READ/WRITE DIGITAL PARAMETERS

Register Name	HTML Address	Description	Type
BCTStart	CSNDD161.htm	Start Battery Condition Test	Bit
BCTStop	CSNDD162.htm	Stop Battery Condition Test	Bit
BCTEnable	CSNDD163.htm	Enable Battery Condition Test	Bit
BCTDisable	CSNDD164.htm	Disable Battery Condition Test	Bit
CntDO1	CSNDD165.htm	Control of Digital Output 1 (Optional)	Bit
CntDO2	CSNDD166.htm	Control of Digital Output 2 (Optional)	Bit

**Once the bit commands are sent to the device they are automatically reset to 0.**

## READ ONLY DIGITAL PARAMETERS

Register Name	HTML Address	Description	Type
CC	MDBAF001.htm	Charge Cycle (Normal Operation)	Bit
OL	MDBAF002.htm	Overload	Bit
MF	MDBAF003.htm	Mains Failure	Bit
BCT	MDBAF004.htm	Battery Condition Test	Bit
BP	MDBAF005.htm	Battery Present	Bit
BM	MDBAF006.htm	Battery Missing	Bit
BL	MDBAF007.htm	Battery Low	Bit
BB	MDBAF008.htm	Battery Bad	Bit
M?	MDBAF009.htm	Power Supply or Mains Failed (Brown Out)	Bit
B?	MDBAF0010.htm	Possibly Battery Missing	Bit
SD	MDBAF0011.htm	System Down	Bit
BO	MDBAF0012.htm	Battery OK during mains/psu fail	Bit
Bcond	MDBAF0013.htm	Battery Condition Test Enabled	Bit
Ret	MDBAF0014.htm	Retry Battery Test on Fail	Bit
TempSign	MDBAF0015.htm	Temperature Sign (1 = Negative, 0 = Positive)	Bit
BatSign	MDBAF0016.htm	Battery Current Sign (1 = Out, = 0 In)	Bit
BCT Start	MDBAF0017.htm	Battery Condition Test Started	Bit
BCT Stop	MDBAF0018.htm	Battery Condition Test Stopped	Bit
BCT Enable	MDBAF0019.htm	Battery Condition Test Enabled	Bit
BCT Disable	MDBAF0020.htm	Battery Condition Test Disabled	Bit
CommsF	MDBAF0021.htm	Communications Failure to Power Supply	Bit
b?	MDBAF0022.htm	Possibly Battery Missing (Battery Bad)	Bit
bM	MDBAF0023.htm	Battery Missing (Battery Bad)	Bit
bO	MDBAF0024.htm	Battery OK during mains/psu fail (Battery Bad)	Bit
bL	MDBAF0025.htm	Battery Low (Battery Bad)	Bit
bP	MDBAF0026.htm	Battery Present (Battery Bad)	Bit
MonDO1	MDBAF0027.htm	Monitoring of Digital Output 1 (Optional)	Bit
MonDO2	MDBAF0028.htm	Monitoring of Digital Output 2 (Optional)	Bit
MonDI1	MDBAF0029.htm	Monitoring of Digital Input 1 (Optional)	Bit
MonDI2	MDBAF0030.htm	Monitoring of Digital Input 2 (Optional)	Bit
MonDI3	MDBAF0031.htm	Monitoring of Digital Input 3 (Optional)	Bit
MonDI4	MDBAF0032.htm	Monitoring of Digital Input 4 (Optional)	Bit
MonDI5	MDBAF0033.htm	Monitoring of Digital Input 5 (Optional)	Bit
MonDI6	MDBAF0034.htm	Monitoring of Digital Input 6 (Optional)	Bit



## INTEGRATING ANALOGUE AND DIGITAL VALUES INTO A WEB PAGE

The previous section showed examples on how to set and display individual bits and analogue values. This is not very useful unless the values can be placed in a complete 'real' website.

### PRE-CONFIGURED WEB PAGES

The screenshot below shows an example of how these values will be displayed in a web page. This pre-configured example is delivered as part of the EtherMBLink Software.

These websites can be used to monitor and set Analogue Values 1 to 200 and Digital Values 1 to 640. The contents of the analogue and digital values depend on the application.

The DoZeener Ethernet interface is a generic card which can be pre-configured to display the desired parameters, whether it is a protocol converter, a dedicated or as user-programmable controller.

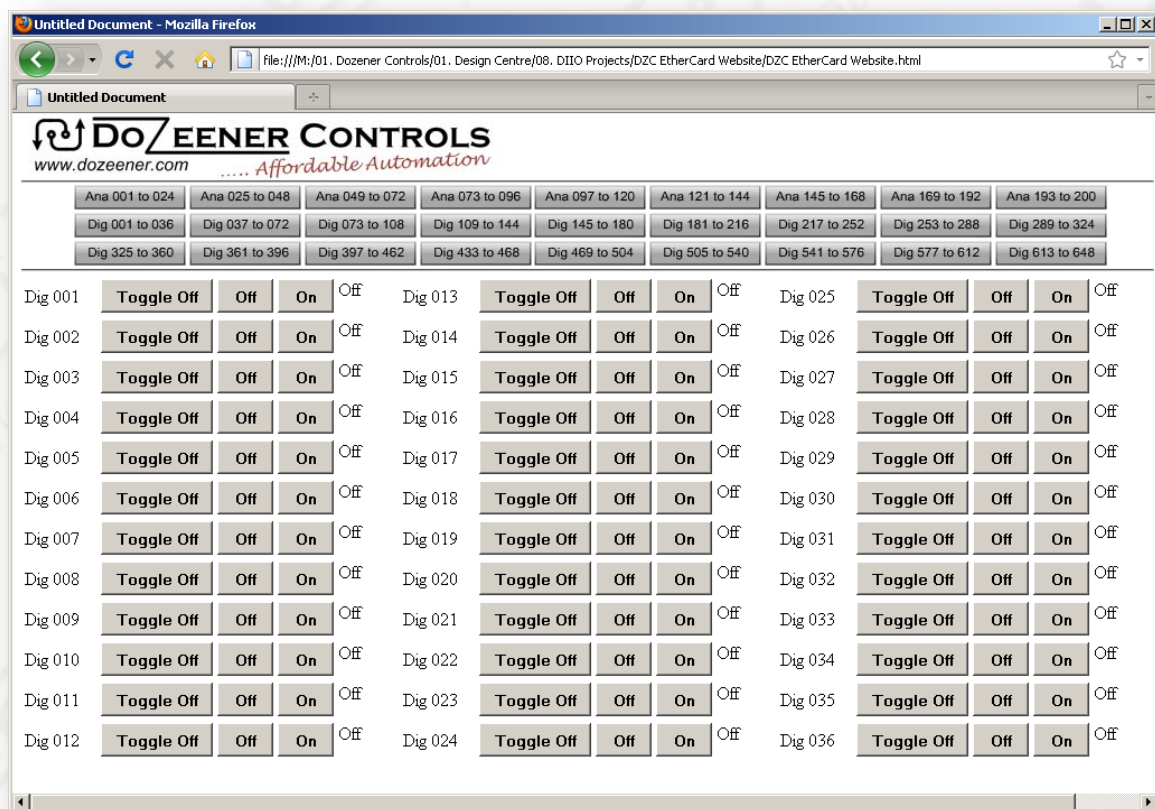

After the software is installed, these pages can be accessed via:

Start – DoZeener Controls – DZC Power EtherMBLink – DZC EtherCard Website.htm

The html source can be used to help configure custom user web pages.

This is also a very good tool to monitor the values inside the Protocol Converter using an internet browser.

This web page uses the host name 'EtherDevice' to access data from the protocol converter. A host name instead of an IP address is used so that the website is easily configurable to connect to any IP address simply by changing the hosts file.



## ADDING A HOST REFERENCE TO THE HOST FILE

The host file in the windows directory is used to resolve a host name into an IP address.

The host file is located here in C:\WINDOWS\system32\drivers\etc\hosts

When the file is opened using notepad, this is how it looks if it has never been edited:

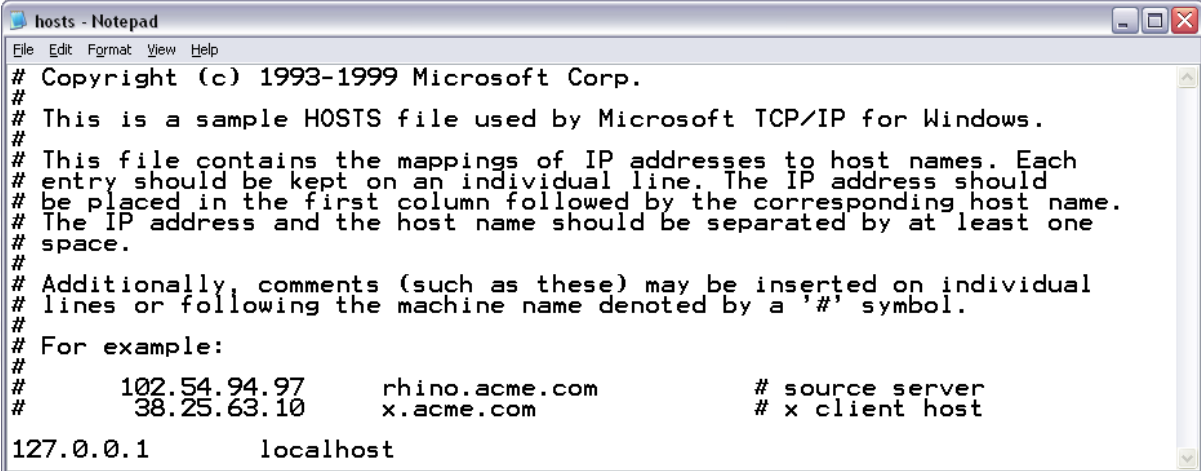

```
hosts - Notepad
File Edit Format View Help
# Copyright (c) 1993-1999 Microsoft Corp.
#
# This is a sample HOSTS file used by Microsoft TCP/IP for Windows.
#
# This file contains the mappings of IP addresses to host names. Each
# entry should be kept on an individual line. The IP address should
# be placed in the first column followed by the corresponding host name.
# The IP address and the host name should be separated by at least one
# space.
#
# Additionally, comments (such as these) may be inserted on individual
# lines or following the machine name denoted by a '#' symbol.
#
# For example:
#
#       102.54.94.97       rhino.acme.com           # source server
#       38.25.63.10      x.acme.com               # x client host
127.0.0.1       localhost
```

To make the website work, the new host name reference to the protocol converter's IP address must be added, i.e.

```
192.168.8.60      EtherDevice
```

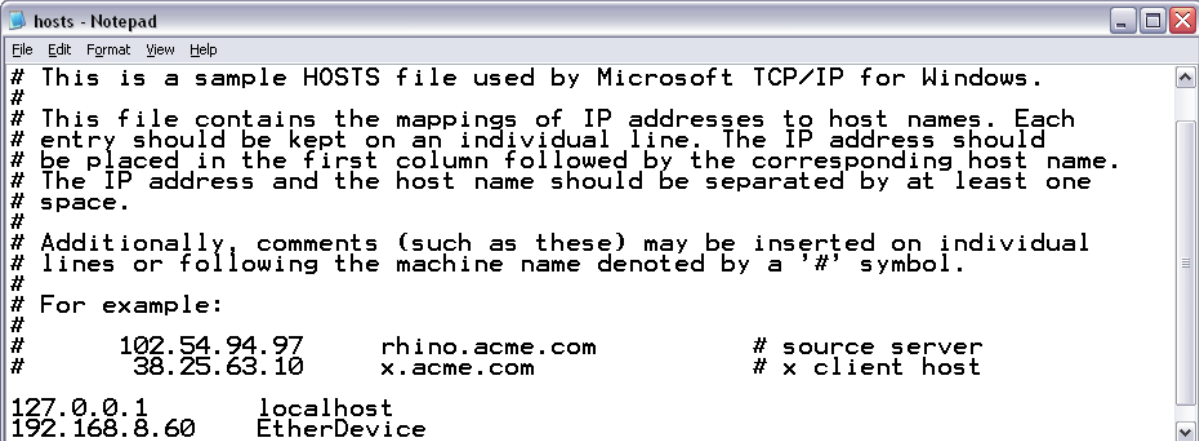

```
hosts - Notepad
File Edit Format View Help
# This is a sample HOSTS file used by Microsoft TCP/IP for Windows.
#
# This file contains the mappings of IP addresses to host names. Each
# entry should be kept on an individual line. The IP address should
# be placed in the first column followed by the corresponding host name.
# The IP address and the host name should be separated by at least one
# space.
#
# Additionally, comments (such as these) may be inserted on individual
# lines or following the machine name denoted by a '#' symbol.
#
# For example:
#
#       102.54.94.97       rhino.acme.com           # source server
#       38.25.63.10      x.acme.com               # x client host
127.0.0.1       localhost
192.168.8.60    EtherDevice
```

After saving the file, pinging the host name is a good test to test whether the new entry had the desired result.

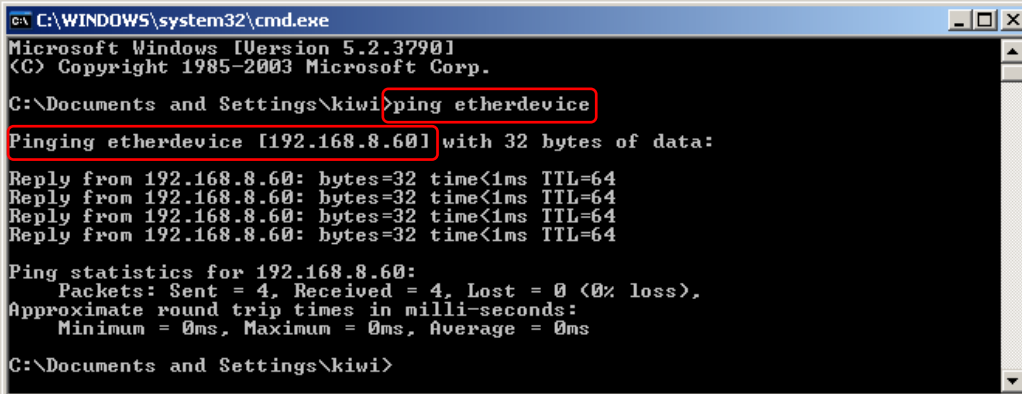

```
C:\WINDOWS\system32\cmd.exe
Microsoft Windows [Version 5.2.3790]
(C) Copyright 1985-2003 Microsoft Corp.

C:\Documents and Settings\kiwi>ping etherdevice
Pinging etherdevice [192.168.8.60] with 32 bytes of data:

Reply from 192.168.8.60: bytes=32 time<1ms TTL=64
Reply from 192.168.8.60: bytes=32 time<1ms TTL=64
Reply from 192.168.8.60: bytes=32 time<1ms TTL=64
Reply from 192.168.8.60: bytes=32 time<1ms TTL=64

Ping statistics for 192.168.8.60:
    Packets: Sent = 4, Received = 4, Lost = 0 (0% loss),
    Approximate round trip times in milli-seconds:
        Minimum = 0ms, Maximum = 0ms, Average = 0ms

C:\Documents and Settings\kiwi>
```

## CREATING A WEB PAGE WITH INFORMATION FROM THE ETHERNET DEVICE

The screenshot below shows how the Ethernet HTML links can be placed on a web page to display information in a meaningful way.

In this case the web browser 'Sea Monkey' is being used. This is a very good free web-browser.

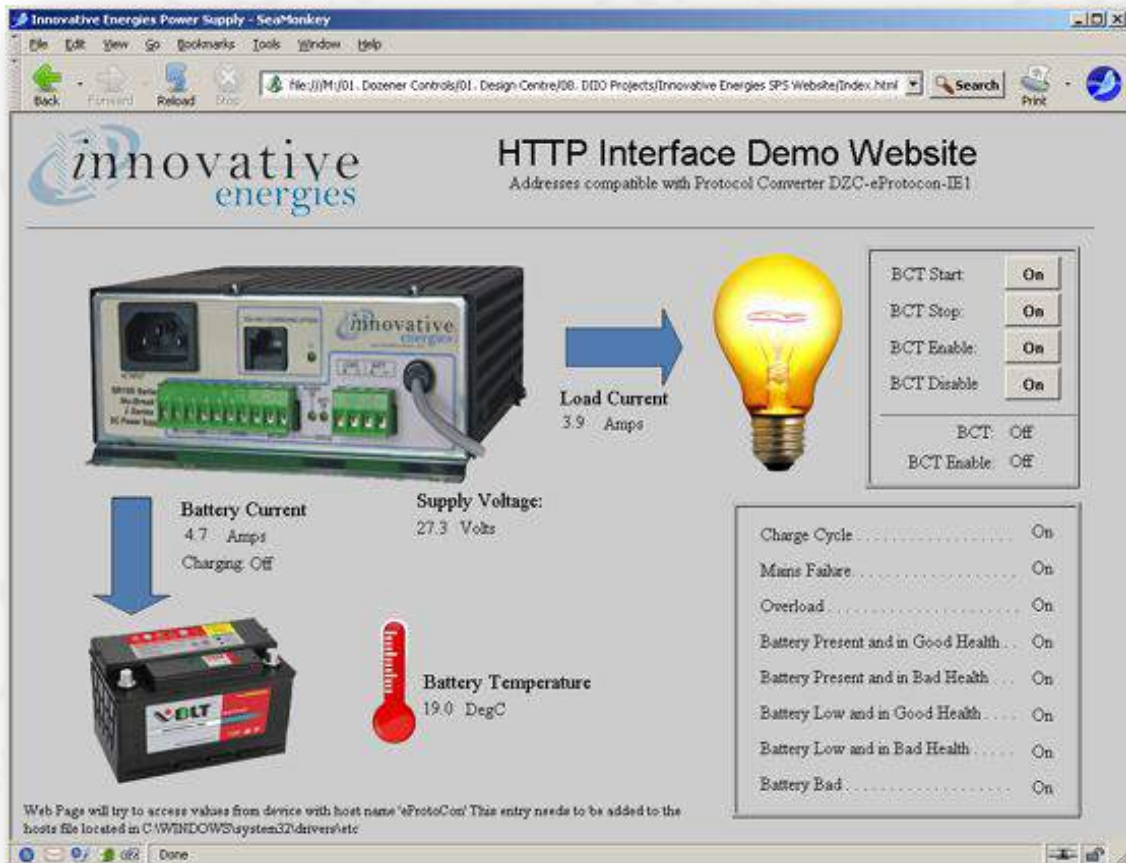

In the sections below, short examples are used to show how values from the Ethernet HTML interface can be placed on a web page.

These are only basic examples. If more advanced languages like Flash are used, more sophisticated effects can be created.

To make this example work the host file has to be edited as shown in the previous section.

## HTML CODE EXAMPLES:

### HTML Code:

```
<head>
<meta http-equiv="Content-Type" content="text/html; charset=iso-8859-1" />
<title>Sample Website</title>
</head>

<body>
</body>
</html>
```

### Web Page:

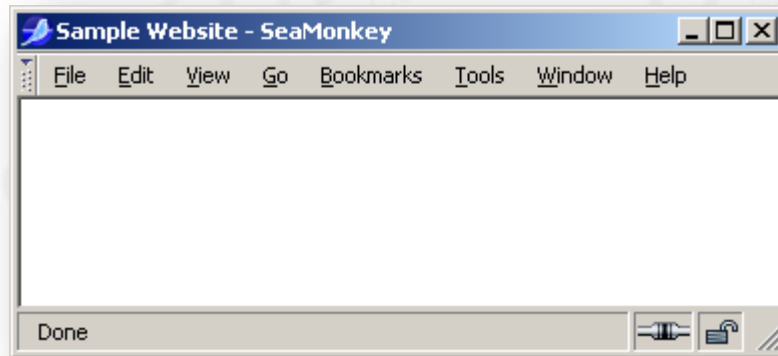

### HTML Code:

The sections highlighted grey are additions over the previous example. Highlights are used to show the effect on the web browser when the html code is added.

```
<head>
<meta http-equiv="Content-Type" content="text/html; charset=iso-8859-1" />
<title>Sample Website</title>
<style type="text/css">
<!--
#Layer1 {
    position:absolute;
    left:44px;
    top:35px;
    width:202px;
    height:31px;
    z-index:1;
}
-->
</style>
</head>
<body>
<div id="Layer1">Status of Analogue Value 1: </div>
</body>
</html>
```

### Web Page:

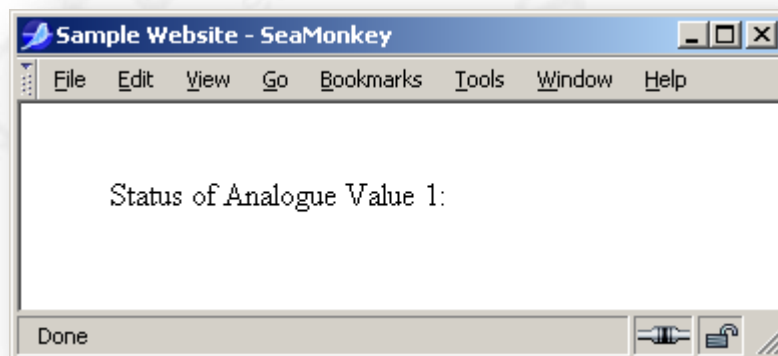

**HTML Code:**

```
<head>
<meta http-equiv="Content-Type" content="text/html; charset=iso-8859-1" />
<title>Sample Website</title>
<style type="text/css">
<!--
#Layer1 {
    position:absolute;
    left:44px;
    top:35px;
    width:178px;
    height:31px;
    z-index:1;
}
-->
</style>
</head>
<body>
<div id="Layer1">Status of Analogue Value 1:
  <iframe src ="http://EtherDevice/MA01C002.htm" frameborder = "0" marginheight = "0"
marginwidth = "0" style="height: 20px; width: 35px" name="I20" id="I20"> </iframe>
</div>
</body>
</html>
```

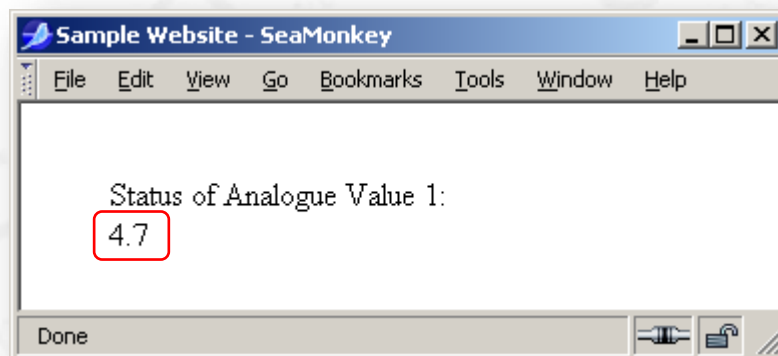
**Web Page:**

**HTML Code:**

```
<head>
<meta http-equiv="Content-Type" content="text/html; charset=iso-8859-1" />
<title>Sample Website</title>
<style type="text/css">
<!--
#Layer1 {
    position:absolute;
    left:44px;
    top:35px;
    width:178px;
    height:31px;
    z-index:1;
}
#Layer2 {
    position:absolute;
    left:43px;
    top:78px;
    width:179px;
    height:37px;
    z-index:2;
}
-->
</style>
</head>
<body>
<div id="Layer1">Status of Analogue Value 1:
    <iframe src ="http://EtherDevice/MA01C002.htm" frameborder = "0" marginheight = "0"
marginwidth = "0" style="height: 20px; width: 35px" name="I20" id="I20"> </iframe>
</div>
<div id="Layer2">Status of Digital Value 1:</div>
</body>
</html>
```

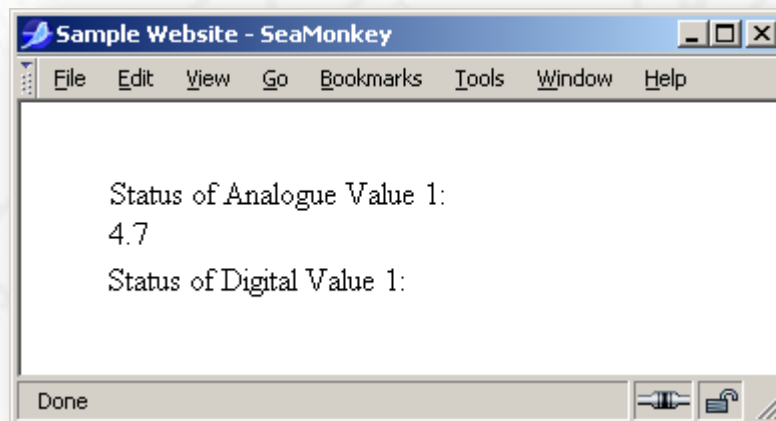
**Web Page:**



### HTML Code:

```
<head>
<meta http-equiv="Content-Type" content="text/html; charset=iso-8859-1" />
<title>Sample Website</title>
<style type="text/css">
<!--
#Layer1 {
    position:absolute;
    left:44px;
    top:35px;
    width:178px;
    height:31px;
    z-index:1;
}
#Layer2 {
    position:absolute;
    left:43px;
    top:78px;
    width:179px;
    height:37px;
    z-index:2;
}
.style3 {margin-bottom: 12px;
}
-->
</style>
</head>
<body>
<div id="Layer1">Status of Analogue Value 1:
    <iframe src ="http://EtherDevice/MA01C002.htm" frameborder = "0" marginheight = "0"
marginwidth = "0" style="height: 20px; width: 35px" name="I20" id="I20"> </iframe>
</div>
<div id="Layer2">Status of Digital Value 1:
    <iframe src ="http://EtherDevice/MDBAC016.htm" frameborder = "0" marginheight = "0"
marginwidth = "0" style="height: 16px; width: 40px" name="I24" id="I24" class="style3"></iframe>
</div>
</body>
</html>
```

### Web Page:

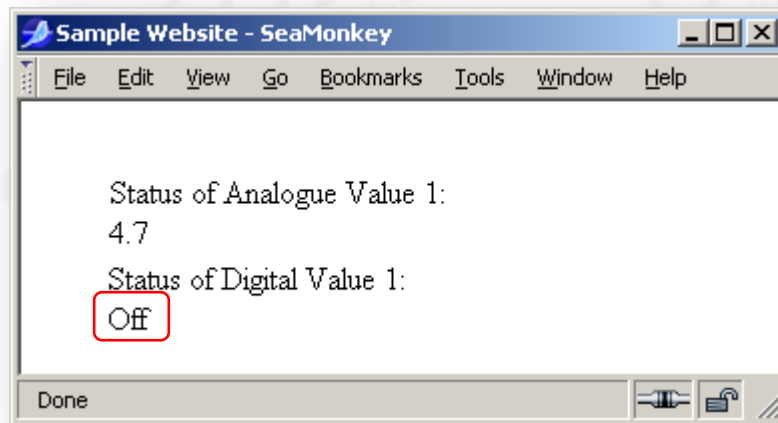

### HTML Code:

```
<head>
<meta http-equiv="Content-Type" content="text/html; charset=iso-8859-1" />
<title>Sample Website</title>
<style type="text/css">
<!--
#Layer1 {
    position:absolute;
    left:44px;
    top:35px;
    width:178px;
    height:31px;
    z-index:1;
}
#Layer2 {
    position:absolute;
    left:43px;
    top:78px;
    width:179px;
    height:37px;
    z-index:2;
}
.style3 {margin-bottom: 12px;
}
#Layer3 {
    position:absolute;
    left:243px;
    top:35px;
    width:55px;
    height:36px;
    z-index:3;
}
-->
```

```
</style>
</head>
<body>
<div id="Layer1">Status of Analogue Value 1:
  <iframe src ="http://EtherDevice/MA01C002.htm" frameborder = "0" marginheight = "0"
marginwidth = "0" style="height: 20px; width: 35px" name="I20" id="I20"> </iframe>
</div>
<div id="Layer2">Status of Digital Value 1:
  <iframe src ="http://EtherDevice/MDBAC016.htm" frameborder = "0" marginheight = "0"
marginwidth = "0" style="height: 16px; width: 40px" name="I24" id="I24" class="style3"></iframe>
</div>
<div id="Layer3">
  <iframe src ="http://uProc/CSNDD001.htm" frameborder = "0" marginheight = "0" marginwidth =
"0" style="height: 30px; width: 50px" name="I23" id="I23"></iframe>
</div>
</body>
</html>
```

**Web Page:**

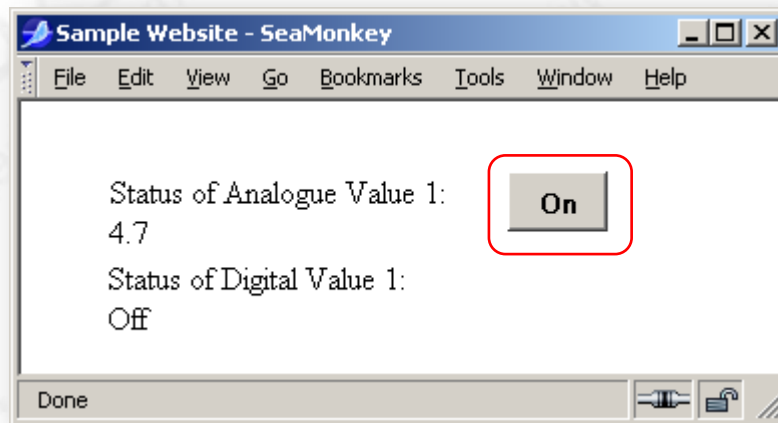

# POWER ETHERMBLINK – PROTOCOL CONVERTER CONFIGURATION AND MONITORING SOFTWARE

## COMMUNICATION SETTINGS

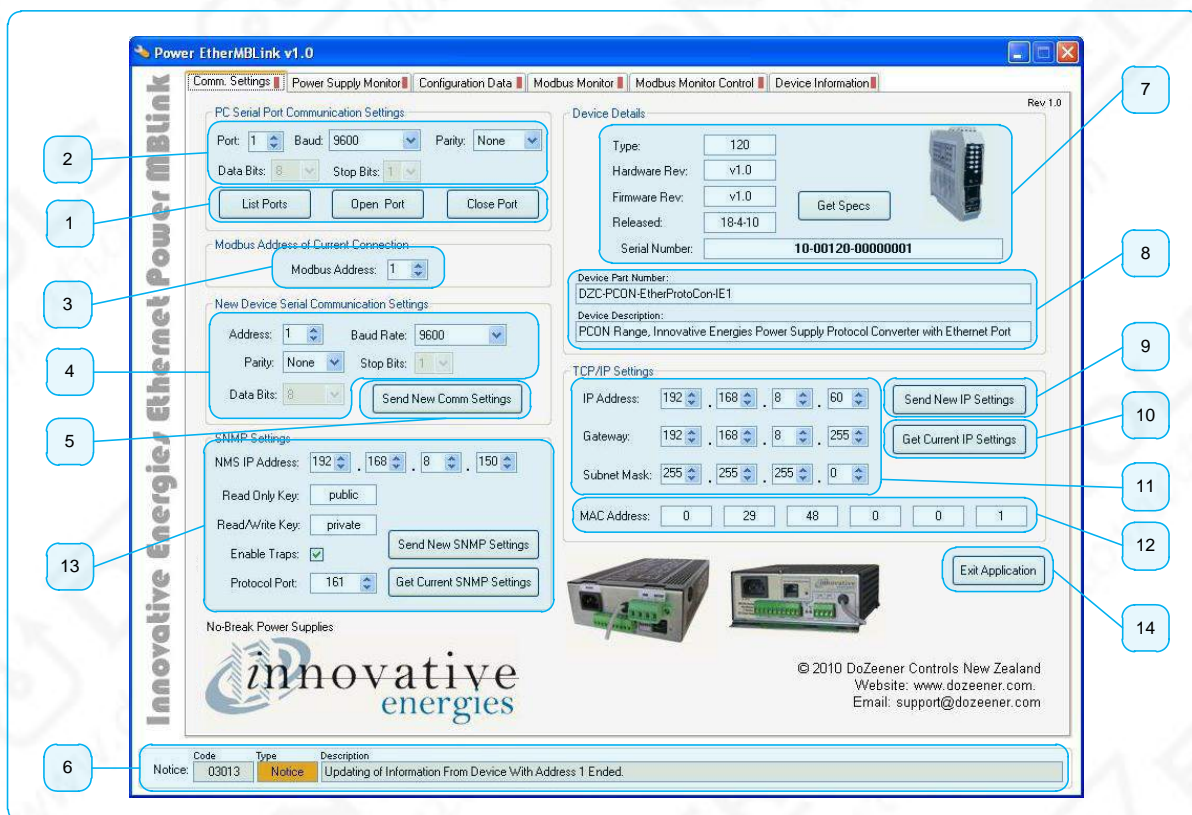

The 'Comm Settings' Section is used for the following functions

- Choosing the PC communication port and comms parameters
- Setting device Modbus address to be configured
- Displaying specifications of the device connected to the serial port
- Displaying Ethernet interface IP Details and MAC Address
- Setting Ethernet interface IP Details

### PC Serial Port Communication Settings

1. These three buttons are associated with the PC serial communication ports. Pressing 'List Port' will display which ports are available on the machine at the bottom of the screen in the Notice area. Open port and close port buttons are used to open and close the serial ports selected in the 'Port' field
2. PC Communication port parameters. Com Ports up to 32 are possible. Baud Rate possibilities are 9600, 14400, 19200, 38400, 56000, 57600 and 115200. The data bits are fixed to 8 and stop bits fixed to 1 and cannot be altered. Parity configuration possibilities are None, Odd, Even, Mark and Space.

### **Modbus Address of Current Connection**

3. This is the device Modbus address connected to the serial port, or in the case the PC is connected to a multi-drop RS485 network, this will be the Modbus address of the device to be configured in the network. This Modbus address only applies to this section, used to configure the device or check the existing device settings.

### **New Device Serial Communication Settings**

4. This section is used to configure new serial parameters or the Modbus address of the device attached to the serial port. Possible selections for the baud rate and parity are as section 2. The data bits and stop bits cannot be changed.
5. By pressing this button all the parameters selected in section 4 will be sent to the Modbus device. A success notice will be displayed at the bottom of the screen if the operation was successful. After using this function, the parameters in section 2 should be changed to match the new configuration and the 'Get Specs' button in section 7 used to confirm that the communication link is healthy.

### **Notice Bar**

6. The 'Notice' area is used to display the result of an operation carried out in the program. When successful the notice 'Type' will change to 'Success' and turn green and associated information shown in the description. Similarly an error will show up as red with an 'Error' text. Information only, which is neither an error nor success, will show up as orange with a 'Notice' text. Every time an operation is carried out the user should check out these fields for feedback.

### **Device Details**

7. This section should be used to check that communication to the device is healthy and that the device connected to the serial port is the expected type. If a link has successfully been established with the Modbus device the parameters will show up in the appropriate fields. These parameters should be sent to the supplier as a reference when requesting help with a particular device to identify the exact part number and production batch. If the connection is not healthy a 'No Comms!' notice will show up in all the fields.
8. This is the re-order part number and description of the device connected to the serial port.

### **TCP/IP Settings**

9. Pressing the 'Send New IP Settings' will send the IP settings entered in section 11 to the device via the serial port. TCP/IP settings can only be set via the serial link.
10. Pressing the 'Get Current IP Settings' will retrieve the IP settings and MAC address of the device connected to the serial port and display them in section 11.
11. These are the IP settings to be sent to the device or setting retrieved from the device. In this model only a static IP address can be set.
12. This is the MAC address of the device. This information will only displayed when the 'Get Current IP settings' button is pressed and the port has successfully connected to the device.

### **SNMP Settings**

13. In this section reading and writing the SNMP setting from and to the device is possible. Refer to 'SNMP' Section for more details.

### **Exit Application**

14. Exits the Power EtherMBlLink software.



## POWER SUPPLY MONITORING TAB

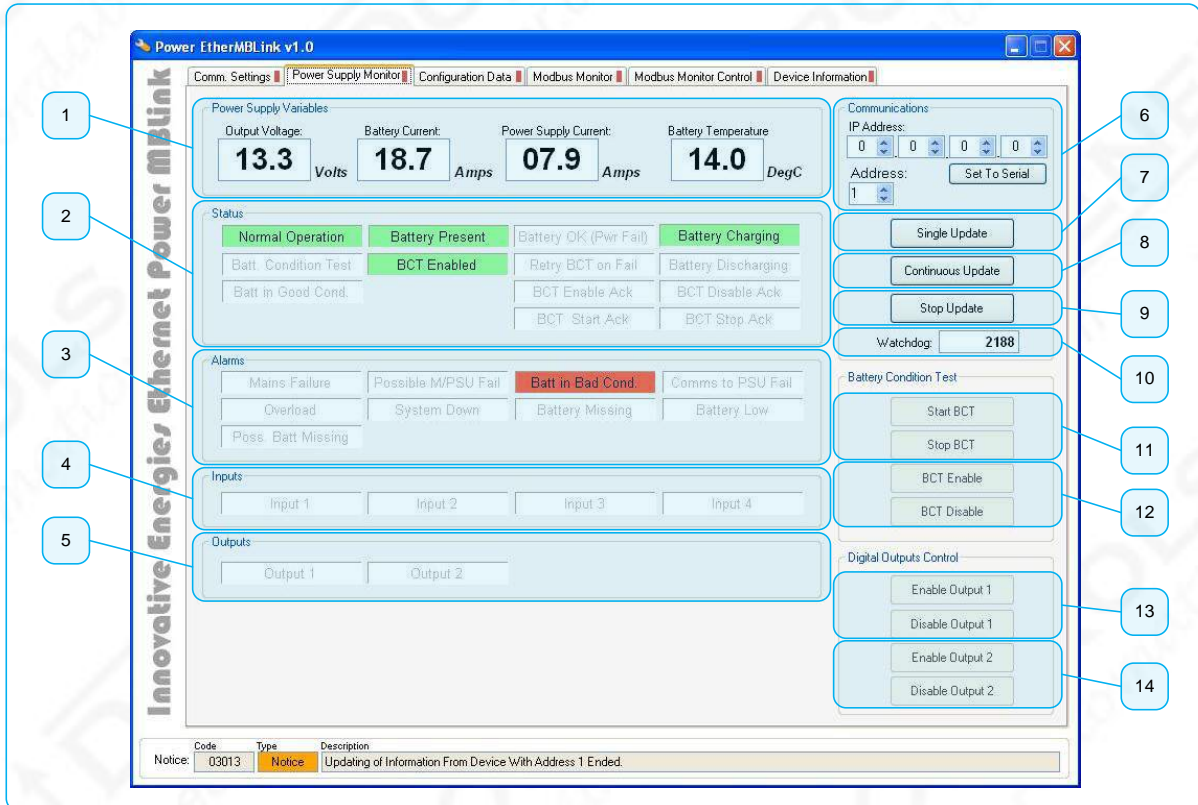

The 'Power Supply Monitoring' Section is used for the following functions

- Monitor the Innovative Energies Power Supply Parameters, Statuses and Alarms
- Start and Stop a Battery Condition Test
- Enable and Disable Automatic Battery Condition Tests
- Switch On and Off the two digital outputs (purchased optionally)
- Monitor the 4 digital inputs (purchased optionally)

Section Descriptions:

### Power Supply Variables

1. Display of the power supply monitoring parameters.

### Status

2. Display of the power supply statuses

### Alarms

3. Display of the power supply alarms

### Inputs

4. Display of the digital inputs status (if available)

### Outputs

5. Display of the digital outputs status (if available)

## Communications

6. The user can set the serial and Ethernet communication parameters in this section. An IP address value of 0.0.0.0 disables Ethernet polling and enables serial polling. Pressing the 'Set To Serial' button will automatically set the IP address value fields to 0. The Address field is the 'Modbus Address' of the protocol converter to be polled or controlled.
7. Pressing the 'Single Update' Button will send a single poll to the protocol converter and request the information only once.
8. Pressing the 'Continuous Update' button will disable all the buttons in the program except those in the 'Battery Condition Test' and 'Digital Output Control' sections. A continuous update means that the software will update the values on the left hand side in real-time.
9. Stop update will re-enable all the buttons in the software and stop the continuous update.
10. The watchdog is a number that will increment from 0 to 65536 and reset back to 0. This should be used to confirm that the values from the protocol converters are being updated successfully. If the watchdog stops changing while the software is doing a continuous update, it means that an error has occurred and the values stopped updating.

## Battery Condition Test

11. Buttons to Start and Stop the Battery Condition Test. These buttons will set the Start or Stop bit of the appropriate Modbus coil addresses to initiate and stop a BCT
12. Buttons to Enable and Disable the Battery Condition Test. These buttons will set the Enable or Disable bit of the appropriate Modbus coil addresses to enable or disable the BCT

## Digital Output Control

13. Buttons to switch On and Off the digital output 1 if available
14. Buttons to switch On and Off the digital output 2 if available

## CONFIGURATION DATA TAB

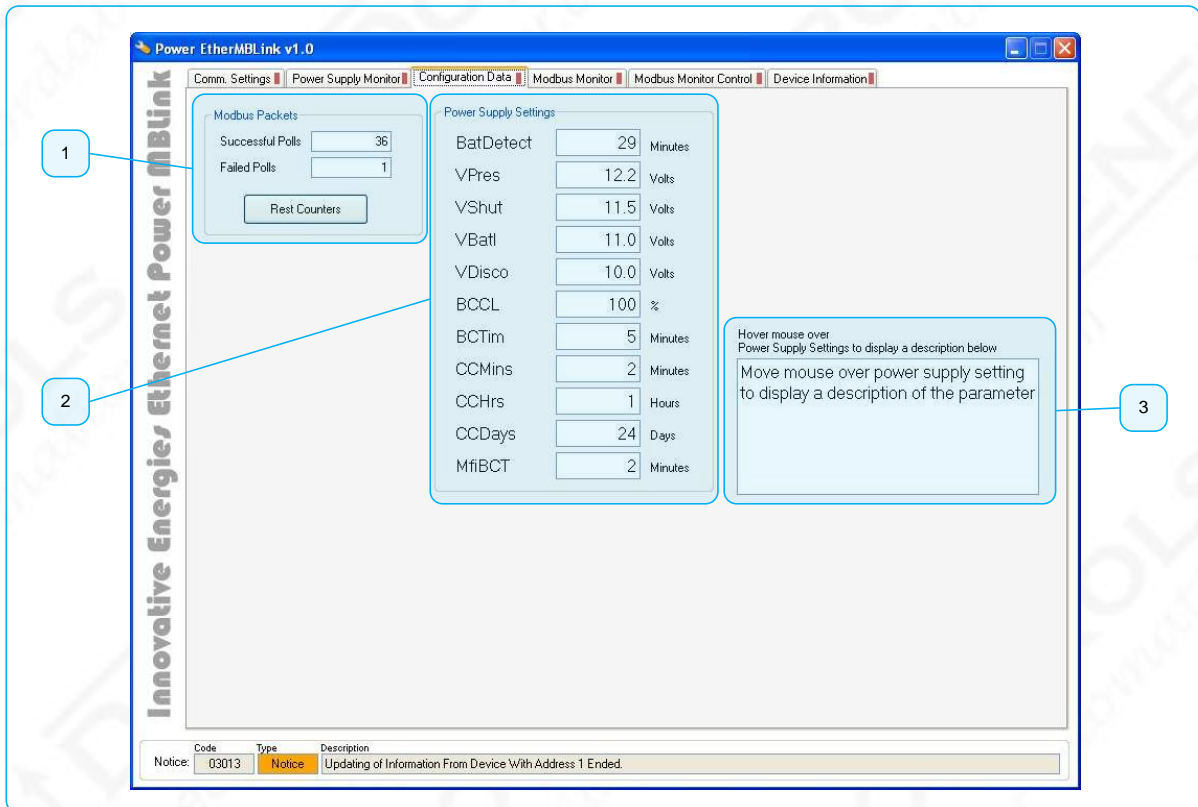

The 'Configuration Data' Section is used for the following functions

- Monitoring the Power Supply Configuration Parameters
- Display the communication statistics while performing a continuous update

Section Descriptions:

### Modbus Packets

1. Display the communication statistics of the continuous update.

### Power Supply Settings

2. Display the power supply configuration parameters
3. Display the information related to each configuration parameters. The information in this section will change as the mouse is hovered over the parameter fields in section 2

## MODBUS MONITOR TAB

The screenshot shows the 'Modbus Monitor' tab in the Power EtherMBlLink v1.0 software. The main window is titled 'Innovative Energies - Single Battery String Power Supply Monitor'. It features a table of monitored registers (1) with columns for Address, Description, Scaling, Value, and Units. To the right, there are configuration panels for 'Serial - Analogue Monitoring Set 1' (6-10), including fields for Modbus Address, Failed Polls, Succeeded Polls, and Decimal Points. Below these are control panels for setting Device Address, IP Address, Register/Coil Address, and New Value (11-15). A 'Display' section (16) shows a list of monitored registers with checkboxes and a status bar (17, 18) at the bottom.

L	Address	Description	Scaling	Value	Units
40001	Unused		1	0	\
40002	Output Voltage		0.1	0	Volts
40003	Unused		1	0	\
40004	Battery Current		0.1	0	Amps
40005	Unused		1	0	\
40006	Power Supply Current		0.1	0	Amps
40007	Unused		1	0	\
40008	Temperature		0.1	0	DegC
40009	Unused		1	0	\
40010	Time between battery detection tests		0.1	0	Minutes
40011	Unused		1	0	\
40012	Minimum volt to detect battery presence		0.1	0	Volts
40013	Unused		1	0	\
40014	Shutdown Voltage		0.1	0	Volts
40015	Unused		1	0	\
40016	Battery low alarm voltage level		0.1	0	Volts
40017	Unused		1	0	\
40018	Battery disconnect voltage		0.1	0	Volts
40019	Unused		1	0	\
40020	Battery charge current limit		0.1	0	%
40021	Unused		1	0	\
40022	Length of battery condition test		0.1	0	Minutes
40023	Unused		1	0	\
40024	Time interval between BCTs		0.1	0	Minutes
40025	Unused		1	0	\
40026	Time interval between BCTs		0.1	0	Hours
40027	Unused		1	0	\
40028	Time interval between BCTs		0.1	0	Days
40029	Unused		1	0	\
40030	Mains fail check interval during BCT		0.1	0	Minutes

The 'Modbus Monitor' section should be used in conjunction with the 'Modbus Monitor Control'. These two tabs enable the user to poll any Modbus registers or coils via the serial or Ethernet link. This is a generic Modbus monitor and can be used with any device capable of communicating via Modbus RTU or Modbus TCP. It is a valuable tool to troubleshoot Modbus devices.

The 'Modbus Monitor' Section is used for the following functions

- Monitoring Modbus registers using function 3 (Poll multiple registers)
- Monitoring Modbus coils using function 1 (Poll multiple coils)
- Controlling Modbus registers using function 6 (Preset single register)
- Controlling Modbus coils using function 5 (Preset single coil)

Section Descriptions:

### Monitoring Table

1. Displays the Modbus registers being monitored. The software can monitor registers in the range 40001 and 49999 and coils in the range 00001 and 99999 using functions 1 and 3 only
2. A user configurable field describing the Modbus register or coil's function. These descriptions can be saved from the 'Modbus Monitor Control' tab.
3. Each register can be scaled to display a meaningful engineering value in section 4. Valid numbers are from 0.001 to 99999
4. If the monitored value is a register, this Value is equal to the register value multiplied by the scaling factor in section 3. For example if the scaling factor is 0.1 and the value of the register is 123, a value of 12.3 will be displayed in this field. If the value is a coil a 0 or 1 will be displayed. For digital values the scaling factor should be set to 1.
5. This column is user configurable and is used to display the engineering units of the register being monitored, if applicable.



## Modbus Monitoring Statistics and General Control

6. This field describes the Modbus set being monitored via the Modbus monitoring table. The text in this field can be set via the 'Modbus Monitor Control' Tab from the control table. This description can be saved using the 'Save' button in the File Controls section.
7. This section shows the Modbus address of the device being polled. If the IP address entered in the table in the Modbus Monitoring Control section is not 0.0.0.0, i.e. it is a valid address, this value will be displayed under the Modbus Address and an IP device will be polled. Failed Polls and Succeeded Polls will show the polling statistics. When one Modbus packet is requested from the Modbus serial or Modbus TCP device and a reply is successfully received the succeeded polls counter will increment by one, otherwise if it fails the Failed Polls counter will be incremented by one.
8. Changing the decimal points value will change the values in section 4. Possible selections are 1 to 4.
9. This section will change the values in section 4. This selection defines how the 16bit number received by the Modbus compatible device will be interpreted. If signed is selected the value displayed will be between -32768 and 32767. If unsigned is selected the value displayed will be between 0 and 65535.
10. The Start buttons starts Modbus polling of all the poll sets enabled in the 'Modbus Monitor Control' Section or section 17 in this tab. The software will poll the serial devices sequentially and the Ethernet devices sequentially. Ethernet devices will be polled while serial devices are also polled, i.e. serial devices will be polled in parallel with Ethernet devices. Due to the mechanism which Windows uses to poll Ethernet devices, if there are a lot of failures in Ethernet polling, this may affect serial polling. This is due to the fact that when the application tries to open a socket to an Ethernet device, this tends to stop all other processes while the system is waiting for the device on the other end to respond. It is recommended that Ethernet devices are not polled at the same time as serial devices.

### Control

11. This is the Modbus address of the device to which the analogue value or digital bit is to be sent.
12. This is the Ethernet address of the device to which the analogue value or digital bit is to be sent.
13. This section applies to both register or coil address. When a value of 1 is entered in this field and the 'Analogue Write' button is pressed the software will send a value to register 40001. When the 'Digital Write' is pressed the software will set or reset the digital coil 00001.
14. When the 'Analogue Write' button is pressed the value in the field 'New Value' will be sent to the register with address defined in section 13
15. When the 'Digital Write' button is pressed the digital coil with address defined in section 13 will be written to the Modbus device. The 'on' and 'off' radio buttons define whether the coil will be switched on or off.
16. These two fields show whether the digital or analogue writes have been successful or failed.

### Display

17. The display table is a summary of the Modbus poll configuration table in the tab 'Modbus Monitor Control'. Up to 28 polls can be configured and will be displayed here. The user can enable or disable the individual polls via the 'E' column. Checking this field will Enable polling. The column 'N' is the **N**umber reference of the poll and corresponds with the numbers in section 18. The descriptions in this table cannot be altered from here but from the 'Modbus Monitor Control' tab.
18. These radio buttons define which information is displayed in the table on the left hand side. They correspond with the table in section 17.



## MODBUS MONITOR CONTROL

**Innovative Energies - Single Battery String Power Supply Monitor**

E	Description	Add	IP Add	Start	Len	Func.	Failed	Success
<input checked="" type="checkbox"/>	Serial - Analogue Monitoring Set 1	1	0.0.0.0	1	30	Fn3	0	0
<input checked="" type="checkbox"/>	Serial - Analogue Monitoring Set 2	1	0.0.0.0	36	1	Fn3	0	0
<input checked="" type="checkbox"/>	Serial - Digital Monitoring 1	1	0.0.0.0	1	26	Fn1	0	0
<input checked="" type="checkbox"/>	Serial - Digital Monitoring 2	1	0.0.0.0	27	6	Fn1	0	0
<input checked="" type="checkbox"/>	Serial - Digital Control	1	0.0.0.0	161	6	Fn1	0	0
<input type="checkbox"/>	Ethernet - Analogue Monitoring Set 1	1	192.168.8.60	1	30	Fn3	0	0
<input type="checkbox"/>	Ethernet - Analogue Monitoring Set 2	1	192.168.8.60	36	1	Fn3	0	0
<input type="checkbox"/>	Ethernet - Digital Monitoring 1	1	192.168.8.60	1	26	Fn1	0	0
<input type="checkbox"/>	Ethernet - Digital Monitoring 2	1	192.168.8.60	27	6	Fn1	0	0
<input type="checkbox"/>	Ethernet - Digital Control	1	192.168.8.60	161	6	Fn1	0	0
<input type="checkbox"/>	Not Configured - 11	1	0.0.0.0	1	30	Fn3	0	0
<input type="checkbox"/>	Not Configured - 12	1	0.0.0.0	1	30	Fn3	0	0
<input type="checkbox"/>	Not Configured - 13	1	0.0.0.0	1	30	Fn3	0	0
<input type="checkbox"/>	Not Configured - 14	1	0.0.0.0	1	30	Fn3	0	0
<input type="checkbox"/>	Not Configured - 15	1	0.0.0.0	1	30	Fn3	0	0
<input type="checkbox"/>	Not Configured - 16	1	0.0.0.0	1	30	Fn3	0	0
<input type="checkbox"/>	Not Configured - 17	1	0.0.0.0	1	30	Fn3	0	0
<input type="checkbox"/>	Not Configured - 18	1	0.0.0.0	1	30	Fn3	0	0
<input type="checkbox"/>	Not Configured - 19	1	0.0.0.0	1	30	Fn3	0	0
<input type="checkbox"/>	Not Configured - 20	1	0.0.0.0	1	30	Fn3	0	0
<input type="checkbox"/>	Not Configured - 21	1	0.0.0.0	1	30	Fn3	0	0
<input type="checkbox"/>	Not Configured - 22	1	0.0.0.0	1	30	Fn3	0	0
<input type="checkbox"/>	Not Configured - 23	1	0.0.0.0	1	30	Fn3	0	0
<input type="checkbox"/>	Not Configured - 24	1	0.0.0.0	1	30	Fn3	0	0
<input type="checkbox"/>	Not Configured - 25	1	0.0.0.0	1	30	Fn3	0	0
<input type="checkbox"/>	Not Configured - 26	1	0.0.0.0	1	30	Fn3	0	0
<input type="checkbox"/>	Not Configured - 27	1	0.0.0.0	1	30	Fn3	0	0
<input type="checkbox"/>	Not Configured - 28	1	0.0.0.0	1	30	Fn3	0	0

General: Interval (In ms) 500, Reset Stats

Poll Control: Start, Stop

File Controls: Load, Save

Modbus TCP Parameters: Comms Timeout (In ms) 100

Notice: 030113 Notice Updating of Information From Device With Address 1 Ended.

### Table and Description

1. The main title is user definable and describes this set of Modbus polls. In this case this Modbus poll definition is called 'Innovative Energies – Single Battery String Power Supply Monitor' because it will poll through 5 polls via the serial interface and 5 polls via the Ethernet interface to display all the information from the Protocol converter connected to the Innovative Energies Power Supply.
2. The 'E' column is the **Enable** column for the individual polls. In the example above only the serial polls are enabled. The Ethernet polls are defined but not enabled; therefore when continuous polling is started they will be ignored.
3. The description column is user definable and will have a general description of the information retrieved in that poll. In the example above part of the Analogue Parameters are located in addresses 1 to 30 and therefore the description reads 'Serial – Analogue Monitoring Set 1'. In this case there are two definition sets – serial and Ethernet, so the description also contains information that this forms part of the serial poll.
4. Modbus Address of the device to be polled. Valid values are 1 to 255.
5. The 'IP Address' column contains the IP Address of the device to be polled. If this value is set to 0.0.0.0, Ethernet polling is disabled and serial polling enabled.
6. The 'Start' column defines the starting Modbus address of the register or coil to be requested. Valid values are 1 to 9999
7. The 'Length' column defines how many registers or coils will be requested. Valid values are 1 to 30.
8. The 'Func.' Column defines the Modbus function used to poll the information. Valid selections are Fn1 (Function 1: Modbus Coils) and Fn3 (Function 3: Modbus Registers).

For example

- if Add = 1, IP Address = 0.0.0.0, Start = 1, Len = 12, Function = Fn3, the software will request registers 40001 to 40012 from a Modbus RTU device with address 1
  - if Add = 12, IP Address = 192.168.8.60, Start = 23, Len = 19, Function = Fn1, the software will request coils 00023 to 00042 from a Modbus TCP device with IP Address 192.168.8.60 and Modbus address 12.
9. The 'Failed' and 'Success' columns show statistics of the defined poll once the continuous poll is initiated.

#### General

10. The interval field is the time between individual polls. The value is in milliseconds. Valid values are 500 (0.5 seconds) to 30000 (30 seconds).
11. Pressing the 'Reset Stats' button will reset the statistics in the columns in section 9

#### Poll Control

12. The 'Start' and 'Stop' buttons will disable all the buttons and start/stop the continuous polling.

#### File Controls

13. The Modbus monitoring feature in this software is compatible with all Modbus RTU and Modbus TCP devices. Once configured for a particular device or set of devices, the definition can be saved to a file. The file extension is \*.dmp which is an abbreviation of 'DoZeener Controls Modbus Poll Definition'. The following information can be saved and loaded:

- Modbus Poll Set Main Description
- Modbus Poll Sets Descriptions
- Modbus Poll Sets Address
- Modbus Poll Sets IP Address
- Modbus Poll Sets Start Address
- Modbus Poll Sets Length
- Modbus Poll Sets Function
- Modbus Poll Registers description
- Modbus Poll Registers scaling
- Modbus Poll Registers units

#### Modbus TCP Parameters

14. The Modbus TCP comms timeout defines how long the wait will be between pinging a device and giving up on the connection. Before a socket is opened and a Modbus TCP poll is sent to the device a 'Ping' is carried out to check whether the device exists on the network. Following a Modbus ping a socket will be opened to the Modbus device.

## DEVICE INFORMATION TAB

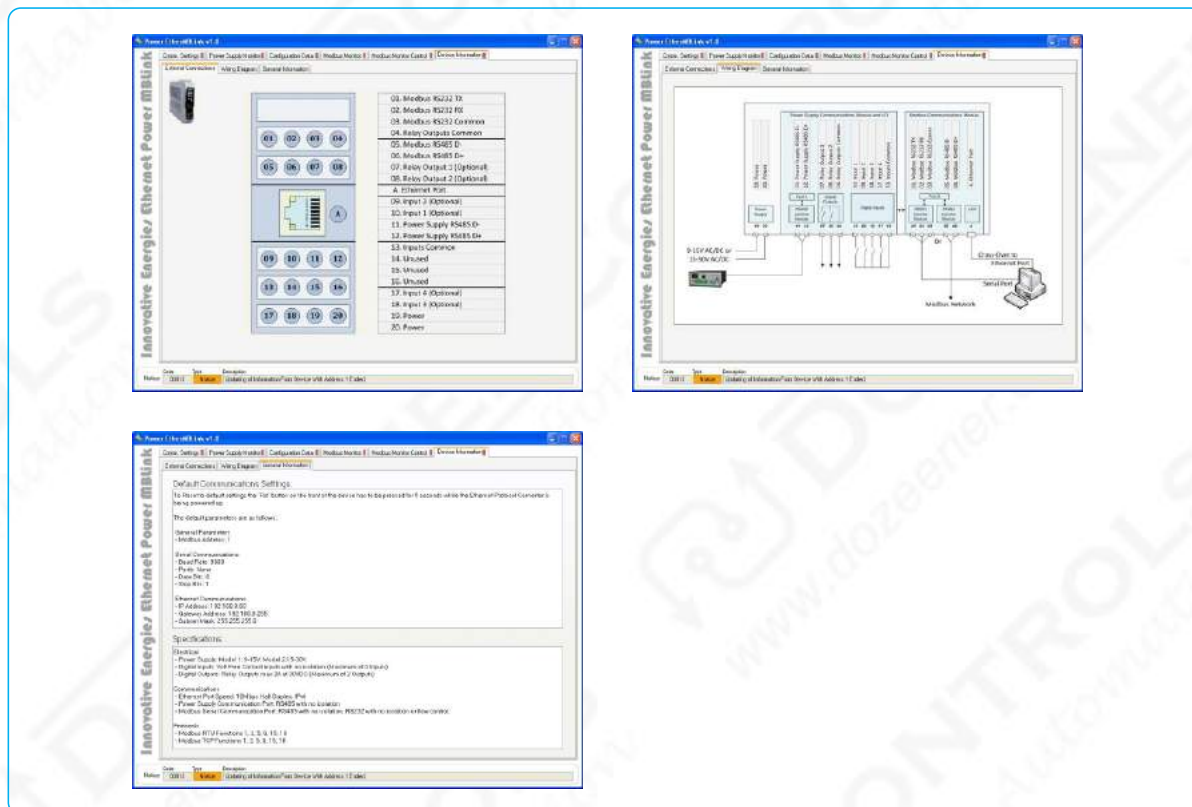

The device information tab shows the following information:

- Protocol Converter physical connections
- Protocol Converter wiring diagram
- Default communication settings and device specifications

## REVISION HISTORY

Revision Number	Date Revised	Revised By	Description
1	9-May-10	RM	Initial Revision
2	12-Jan-11	RM	Added section 'Read Only Coils (New Register Set) to match update in the device firmware
3	7-Sep-11	RM	Updates on pages 11 and 12. Corrected address from 25 to 35 and changed to 22 to 32. Added Section 'SNMP' and modified the picture and description on page 40 to include SNMP information.