

# BRAVO ECI - 230 VAC

## User Manual V1.5

### BEYOND THE INVERTER

THE NEW GENERATION OF POWER CONVERTERS

- **DUAL INPUT INVERTER**  
Commercial Power as default source
- **AC BACKUP IN A DC ENVIRONMENT**  
Leverage your existing DC infrastructure
- **ONE STOP SHOP**  
Wide output power range
- **HARSHEST AC INPUT CONDITIONS**  
Without compromising the quality of the AC output



# Table of content

---

1. at a glance.....	6
2. Abbreviations.....	7
3. Warranty and Safety Conditions .....	8
3.1 Disclaimer .....	8
3.2 Technical care .....	8
3.3 Installation .....	9
3.3.1 Handling.....	9
3.3.2 Surge and transients .....	9
3.3.3 Other.....	9
3.4 Maintenance .....	10
3.5 Replacement and Dismantling.....	10
4. ECI TECHNOLOGY .....	11
4.1 On-line Mode .....	12
4.2 Safe mode.....	12
4.3 EPC-mode.....	12
4.4 Mix mode & Walk-in mode .....	12
5. Building Blocks .....	13
5.1 Inverter .....	13
5.2 Sub-rack.....	13
5.3 Monitor unit T2S ETH.....	14
6. Accessories .....	15
6.1 Cabinet .....	15
6.2 Manual By-Pass .....	15
6.3 AC Distribution Unit .....	16
6.3.1 Miniature Circuit Breakers .....	16
6.3.2 MCCB.....	16
7. Monitoring Accessories .....	17
7.1 Catena .....	17
8. System Design.....	18
8.1 A la Carte .....	18
9. Installation of Bravo ECI Shelf.....	19
9.1 Mounting kit for Bravo ECI shelf.....	19
9.2 Electrical installation for Bravo Shelf.....	20
9.2.1 Pre requisites .....	20
9.2.2 Terminations .....	21
9.2.3 Grounding .....	21
9.2.4 DC Input.....	22
9.2.5 AC Input .....	22
9.2.6 AC Output.....	22

9.2.7	Signalling .....	23
9.2.8	Remote ON/OFF.....	24
9.2.9	Internal bus (ECI Bus 6 pin / ECI Bus 8 pin) .....	24
9.2.10	Rear cover.....	25
<b>10.</b>	<b>Installation of Cabinet (A la Carte) .....</b>	<b>26</b>
10.1	Unpacking the system .....	26
10.2	Module packing.....	26
10.3	Removing the cabinet rear protection .....	27
10.4	Electrical installation .....	27
10.4.1	Positioning .....	28
10.4.2	Cabling.....	28
10.4.3	Grounding .....	29
10.4.4	Surge Suppression .....	29
10.4.5	AC Input (X2) .....	29
10.4.6	DC Input (X1).....	30
10.4.7	Connection Table – AC Input (X2) & Output (X4) for 48 Vdc and 380 Vdc version.....	32
10.4.8	Connection Table DC Input 48 VDC (X1).....	32
10.4.9	Connection Table DC Input - 380 VDC (X1) .....	33
10.4.10	Signalling .....	33
<b>11.</b>	<b>Interface .....</b>	<b>36</b>
11.1	Inverter module .....	36
11.2	T2S ETH.....	36
<b>12.</b>	<b>Inserting/removing/replacing - modules.....</b>	<b>37</b>
12.1	ECI Inverter .....	37
12.1.1	Removal.....	37
12.1.2	Inserting.....	37
12.2	T2S ETH.....	38
12.2.1	Removal.....	38
12.2.2	Inserting.....	38
12.3	Fan replacement .....	38
<b>13.</b>	<b>AC Output Distribution.....</b>	<b>39</b>
13.1	Miniature Circuit breaker Installation/Removal.....	39
13.2	MCCB.....	39
<b>14.</b>	<b>Manual By-Pass.....</b>	<b>40</b>
14.1	Pre-requisites.....	40
14.2	For those who integrate the MBP into their cabinet.....	40
14.2.1	Normal to By-Pass.....	41
14.2.2	By-Pass to Normal .....	41
14.3	Helios 20 kVA Manual By-Pass and termination box .....	41
14.3.1	Normal to By-Pass.....	41
14.3.2	By-Pass to Normal.....	42

---

15. Finishing .....	43
16. Commissioning .....	44
16.1 Check list.....	45
17. Trouble Shooting and Defective Situations Fixing.....	46
17.1 Trouble Shooting .....	46
18. Maintenance .....	47
18.1 Access T2S with Laptop .....	47
18.2 Manual check.....	47
18.3 Optional .....	47
18.4 Manual By-Pass .....	47
19. Defective modules .....	48
20. Appendix.....	49
20.1 Mains connection, Single phase .....	49
20.2 Mains connection, Three phases.....	50
20.3 System default T2S ETH relay mapping .....	51
20.4 Parameters setting .....	52

Release Note:

<b>Version</b>	<b>Release date (DD/MM/YYYY)</b>	<b>Modified page number</b>	<b>Modifications</b>
1.0	31/03/2017	-	First release of the Manual.
1.1	20/10/2017	-	Amendment and correction.
1.2	24/05/2018	-	Updated the Shelf details.
1.3	04/10/2018	40	Added Inrush information.
1.4	23/04/2019	-	New Layout.
1.5	14/06/2019	32	Updated table values

---

# 1. Helios Power Solutions

---

Our product is an innovative AC backup solution that unlike most used UPS's

- Maximizes the operator's applications uptime;
- Operates with lowest OPEX;
- Provides best protection to disturbances;
- Optimizes footprint.

Our systems are:

- Modular
- Truly redundant
- Highly efficient
- Maintenance free
- Battery friendly

60+ years expertise in power conversion together with worldwide presence to provide customized solutions and extended service

## 2. Abbreviations

---

ECI	Enhanced Conversion Innovation
EPC	Enhanced Power Conversion
REG	Regular
DSP	Digital Signal Processor
AC	Alternating current
DC	Direct current
ESD	Electro Static Discharge
MET	Main Earth Terminal
MBP	Manual By-pass
TCP/IP	Transmission Control Protocol/Internet Protocol
USB	Universal Serial Bus
PE	Protective Earth
N	Neutral
PCB	Printed Circuit Board
TRS	True Redundant Structure
MCB	Miniature Circuit Breaker
MCCB	Molded Case Circuit Breaker
CB	Circuit Breaker

## 3. Warranty and Safety Conditions\*

### WARNING:

The electronics in the power supply system are designed for an indoor, clean environment.

When installed in a dusty and/or corrosive environment, outdoor or indoor, it is important to:

- Install an appropriate filter on the enclosure door, or on the room's air conditioning system.
- Keep the enclosure door closed during operation.
- Replace the filters on a regular basis.

### Important Safety Instructions and Save These Instructions.

#### 3.1 Disclaimer

- The manufacturer declines all responsibilities if equipment is not installed, used or operated according to the instructions herein by skilled technicians according to local regulations.
- Warranty does not apply if the product is not installed, used and handled according to the instructions in the manuals.

#### 3.2 Technical care

- This electric equipment can only be repaired or maintained by a "qualified employee" with adequate training. Even personnel who are in charge of simple repairs or maintenance are required to have knowledge or experience related to electrical maintenance.
- Please follow the procedures contained in this Manual, and note all the "DANGER", "WARNING" AND "NOTICE" marks contained in this Manual. Warning labels must not be removed.
- Qualified employees are trained to recognize and avoid any dangers that might be present when working on or near exposed electrical parts.
- Qualified employees know how to lock out and tag out machines so the machines will not accidentally be turned on and injure employees working on them.
- Qualified employees also know safety related work practices, including those by OSHA and NFPA, as well as knowing what personal protective equipment should be worn.
- All operators are to be trained to perform the emergency shut-down procedure.
- Never wear metallic objects such as rings, watches, or bracelets during installation, service and maintenance of the product.
- Insulated tools must be used at all times when working with live systems.
- When handling the system/units pay attention to sharp edges.

---

\* These instructions are valid for most Helios Products/Systems. Some points might however not be valid for the product described in this manual



### 3.3 Installation

- This product is intended to be installed only in restricted access areas as defined by UL60950 and in accordance with the National Electric Code, ANSI/NFPA 70, or equivalent agencies.
- The Inverter System may contain output over current protection in the form of circuit breakers. In addition to these circuit breakers, the user must observe the recommended UL listed upstream and downstream circuit breaker requirements as defined in this manual.
- Please use extreme caution when accessing circuits that may be at hazardous voltages or energy levels.
- The modular inverter rack is a dual input power supply. The complete system shall be wired in a way that both input and output leads can be made power free.
- REG systems and EPC systems that have no AC input wired and connected can be seen as independent power sources. To comply with local and international safety standards N (output) and PE shall be bonded. The bonded connection between N (output) and PE must be removed once the AC input is connected.
- AC and DC circuits shall be terminated with no voltage / power applied.
- The safety standard IEC/EN62040-1-1 requires that, in the event of an output short circuit, the inverter must disconnect in 5 seconds maximum. The parameter can be adjusted on T2S ETH; however, if the parameter is set at a value > 5 seconds, an external protection must be provided so that the short circuit protection operates within 5 seconds. Default setting is 60 seconds.
- The system is designed for installation within an IP20 or IP21 environment. When installed in a dusty or humid environment, appropriate measures (air filtering ...) must be taken.

#### 3.3.1 Handling

- The cabinet shall not be lifted using lifting eyes.
- Remove weight from the cabinet by unplugging the inverters. Mark inverters clearly with shelf and position for correct rebuild. This is especially important in dual or three phase configurations.
- Empty inverter positions must not be left open. Replace with module or cover.

#### 3.3.2 Surge and transients

The mains (AC) supply of the modular inverter system shall be fitted with Lightning surge suppression and Transient voltage surge suppression suitable for the application at hand. Manufacturer's recommendations of installation shall be adhered to. Selecting a device with an alarm relay for function failure is advised.

Indoor sites are considered to have a working lightning surge suppression device in service.

- Indoor sites Min Class II.
- Outdoor sites Min Class I + Class II or combined Class I+II. The modular inverter system/rack can reach hazardous leakage currents. Earthing must be carried out prior to energizing the system. Earthing shall be made according to local regulations.

#### 3.3.3 Other

- Isolation test (Hi-Pot) must not be performed without instructions from the manufacturer.

### 3.4 Maintenance

- The modular inverter system/rack can reach hazardous leakage currents. Earthing must be carried out prior to energizing the system. Earthing shall be made according to local regulations.
- Prior to any work conducted on a system/unit make sure that AC input voltage and DC input voltage are disconnected.
- Inverter modules and shelves contain capacitors for filtering and energy storage. Prior to accessing the system/modules after power down, wait at least 5 minutes to allow capacitors to discharge.
- Some components and terminals carry high voltage during operation. Contact may result in fatal injury.

### 3.5 Replacement and Dismantling

- ESD Strap must be worn when handling PCB's and open units.
- Helios cannot be held responsible for disposal of the Inverter system and therefore the customer must segregate and dispose of the materials which are potentially harmful to the environment, in accordance with the local regulations in force in the country of installation.
- If the equipment is dismantled, to dispose of its component products, you must comply with the local regulations in force in the country of destination and in any case avoid causing any kind of pollution.

# 4. ECI TECHNOLOGY <sup>1</sup>

Inverter modules carrying the ECI logo and the EPC mark are triple port converters (AC in, DC in, AC out). Sinusoidal output is converted from Mains or/and DC.

The block diagram below gives an explicit description of the topology and operation.

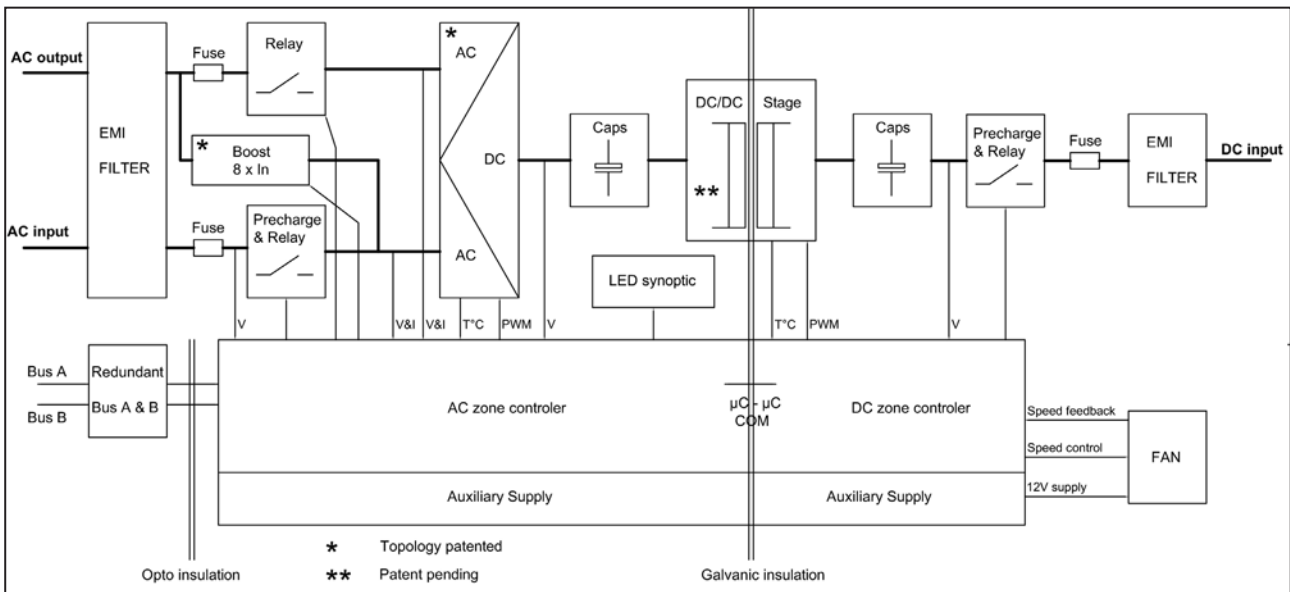

The module is built around the following sub-converters

- AC to DC at input
- DC to DC at input
- DC to AC at output

The energy can flow either from the AC source or the DC source under the control of the local DSP controller. Thanks to internal energy buffering, the output sine wave is constant and disturbance free regardless of the active source.

The BOOST functionality multiplies the nominal current for a period of 20 ms (max) in the event of down stream failures. The upstream breakers do not have to be oversized to prevent tripping. The overload capacity is 125% for 15 seconds.

The ECI works according to True Redundant Structure (TRS) that features decentralized and independent logic, redundant communication bus and three internal levels of disconnection to isolate a module after internal failure.

This functionality is included in every inverter module. Running them in parallel provides a modular system with, no single point of failure, always-conditioned output, high system efficiency and 0 ms source transfer time.

<sup>1</sup> Information and data given in this chapter is intended to serve as an overview of the ECI Technology. Detailed features and parameters for each individual module type in the range may differ and should be referred to in the dedicated data sheet.

## 4.1 On-line Mode

DC is the primary source of supply whilst Mains (AC) works as the secondary source. Switching time between DC input and AC input is 0 ms (source transfer). The power delivered by the DC source (usually a battery, but possibly any other type of DC generator) is converted to provide regulated and transient-free power to the load. In the event of a short circuit on the load side, the boost is automatic, timely and energized for a specific duration to trip downstream protective devices.

## 4.2 Safe mode

Safe mode uses DC as the primary source of supply while Mains (AC) is on standby.

Mains (AC) is normally disconnected through an internal inlet relay and is only connected when down stream clearance is required (boost) or if DC is unavailable.

The transfer between DC and AC results in a typical transfer time of 10 ms.

Typically the safe mode is used in extremely harsh environments such as railways. Under such conditions, it provides extra isolation against mains-borne disturbances.

## 4.3 EPC-mode

Mains input (AC) is the primary source whilst DC works as backup.

The ECI is designed to operate on Mains on a permanent basis and to deliver output voltage conditioned with low THD.

The output sine wave is physically independent of whether the source is AC (or) DC. If the Mains is out of tolerance or goes down, the converter seamlessly switches to DC and the converter operates in "Back-up mode" (Changeover switching time is 0 ms).

As soon as the Mains returns to its valid range, the EPC mode is automatically resumed.

The EPC mode offers higher efficiency (up to 96% depending on the model) without compromising the purity of the output sine wave.

### Remarks: REG modules:

Inverter modules carrying the ECI logo together with the REG mark work only with DC input. Sinusoidal output is converted from DC with the module operating as a traditional inverter. EPC mode and the boost are not available with REG modules.

## 4.4 Mix mode & Walk-in mode

Under some circumstances the DC and AC sources can be combined. The sequence is defined by a user selectable set of parameters. Start, control and exit are fully automatic.

A specific example of Mix-mode is the Walk-in mode where the transfer from DC source to AC source is ramped up within a fixed and adjustable period of time.

## 5. Building Blocks

### 5.1 Inverter

Telecom / Datacom:	Input	48 Vdc 230 Vac, 50/60 Hz
	Output	230 Vac
	Power	3000 VA / 2400 W
Datacom	Input	380 Vdc 120 / 230 / 277 Vac 50/60 Hz
	Output	120 / 208 / 230 / 277 Vac
	Power	3000 VA / 2500 W



- The Bravo ECI is a 3000 VA / 2500 W triple port inverter.
- The Bravo ECI inverter modules are hot swappable and hot pluggable.
- The module operator interface is LEDs showing converter status and output power.
- The inverter modules is equipped with soft start.
- Fan is equipped with alarm and run time meter. The fan is field replaceable.
- 435 mm (D) x 102 mm (W) x 88 mm (H).
- 5 Kg.

### 5.2 Sub-rack

- The Bravo ECI shelf shall be integrated in min 600 mm deep cabinets, Inch/ETSI mounting.
- The Bravo ECI shelf house max four (4) inverter modules and one (1) monitor unit.
- The extension shelf house max four (4) inverter modules and one (1) monitor blank.
- The Bravo ECI shelf is designed with individual DC input, Common AC input and Common AC output.
- Optional rear cover for IP 20 in open rack.
- Max 12 KVA per shelf.
- 480 mm (D) x 19" (W) x 2U (H).
- 6 Kg empty.



### 5.3 Monitor unit T2S ETH

The T2S ETH stands for T2S Ethernet. It replaces the former T2S with the same form factor but with a front Ethernet connector replacing the former USB one. Like his predecessor, T2S ETH is a monitoring solution for the full ECI inverter range and is able to monitor up to 32 inverters through a friendly web base interface.

This new monitoring device provides a graphical user interface, embeds a SNMPv1 agent and is compatible with Catena if one needs a touch screen display. It also allows user to change the configuration of the system.



- T2S ETH provides 3 leds: Red for major alarm signaling, orange led for minor alarm signaling and green led for power and network connection status.
- The RJ45 is a standard ETH connector that could be connected on any IPv4 network

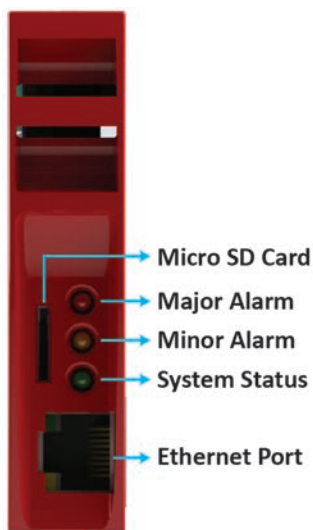

**Note:** Operation of T2S ETH is described in separate manual available on request.

## 6. Accessories

### 6.1 Cabinet

Powder coated (RAL 7024), 19 inch Flat Pack cabinet with 600 x 600 mm foot print. Cabinet designed for top cabling or bottom cabling.

- 1100 mm (600 x 600 mm) 21U
- 1800 mm (600 x 600 mm) 37U
- 2100 mm (600 x 600 mm) 44U

The cabinet comes with a separable top cover to facilitate cabling. Tie strap support at cable entrance/exit.

Door accessory optional.

### 6.2 Manual By-Pass

The manual By-Pass operates via manually operated switches that create a by-pass from mains input to output AC distribution. When in By-Pass, shelves and modules have no AC IN supply, but DC is still present.

To remove the shelf, make sure that the DC feed is off and disconnected.

The manual by-pass is "Make before Break"

NOTE! When the system is in by-pass the load is subjected to mains disturbances.

#### WARNING

**IF AN ATS (Automatic Transfer Switch) IS INSTALLED UPSTREAM, MAKE SURE THAT IT DOES NOT ALLOW TRANSFER BETWEEN AC SOURCES OUT OF SYNC. THE MAXIMUM ALLOWED PHASE SHIFT IS 10°.**

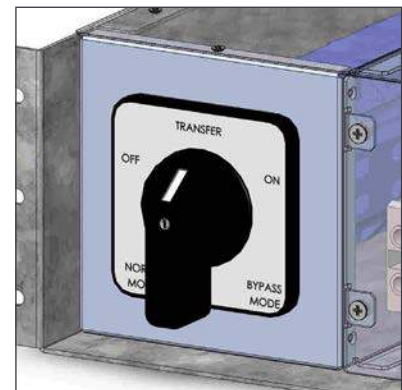

For illustration only

## 6.3 AC Distribution Unit

### 6.3.1 Miniature Circuit Breakers



The standard AC output distribution unit is designed with a 35 mm DIN rail, Multi Clip termination board and N/PE copper terminal bars, and built as a part of the cabinet.

The Multi Clip offers unique flexibility during installation and expansion. The terminals are spring loaded and adapt contact pressure to the size of conductor. Only one cable can be inserted per spring loaded terminal.

The AC distribution unit is available with 1 pole, 2 pole or 3 poles.

Max current per AC DU is 200 A, max current per terminal connector is 40 A. Two adjacent terminal connectors shall be used for 63 A breakers.

If an alarm is required for AC output breakers, a help contact attached to each individual breaker is used (OF or SD). The alarm function is common and uses one of the digital inputs on the control unit. The help contact limits the breakers quantity.

	Single pole		Double pole		Three pole	
	w/o help contact	With help contact OF/SD	w/o help contact	With help contact OF/SD	w/o help contact	With help contact OF/SD
Up to 40A	24	16	12	9	8	6

### 6.3.2 MCCB



AC output distribution via MCCB in the range up to 400 A (1p, 2p or 3p).

Max two MCCB per inverter cabinet.



## 7. Monitoring Accessories

### 7.1 Catena

Catena GUI Interface is a powerful web based touch screen graphical display, it allows user to easily access and monitor the system.

In addition to the touch screen display, user can also access to same GUI by using an Ethernet port which is present on the catena.



- Measures
  - AC In
  - DC In
  - AC Out
- Alarms
  - Major/Minor
  - System Level
  - Phase Information
  - Module Information
- 7" touchscreen
- Web browser with laptop (ETH)
- Height: 3U

## 8. System Design

### 8.1 A la Carte

The A la Carte is pre-assembled and configured as a single phase or three phase system. The system comprises cabinet, inverter sub rack, inverter modules (48 Vdc and 380 Vdc), manual by-pass, monitor device and AC output distribution.

The A la Carte is available in EPC (Enhanced Power Conversion) or REG (Regular) mode.

The A la Carte (single phase) accommodates 1 to 32 modules, for max 96 kVA.

The A la Carte (three phase) accommodates 3 to 30 modules, for max 90 kVA.

By using TUS, the system can parallel up to 2700 kVA

- Dual input (AC and DC) inverter modules (EPC).
- 96% efficiency during normal operation (EPC).
- Always conditioned and filtered output voltage.
- Seamless transfer (0 ms) between primary and secondary source of supply.
- No single point of failure.
- Flexible AC output distribution.
- Full modularity and redundancy.



## 9. Installation of Bravo ECI Shelf

- Read safety instructions prior starting any work.
- Do NOT attempt to use lifting eyes to erect the cabinet.
- System is preferable handled without modules.
- Pay attention to the module position, make sure that modules are repositioned in the same slot.
- T2S ETH is always mounted in the first shelf, left hand position.
- In three phase systems, the modules are configured as per phase 1 (A, R), phase 2 (B, S) and phase 3 (C, T). As long as the system is not in operation, make sure that modules from one phase are not mixed with modules from another phase.  
(When the system is running, modules can be moved from one phase to another without issue.)

### 9.1 Mounting kit for Bravo ECI shelf

The fixing brackets, together with the sliders, allow for different cabinet depths.

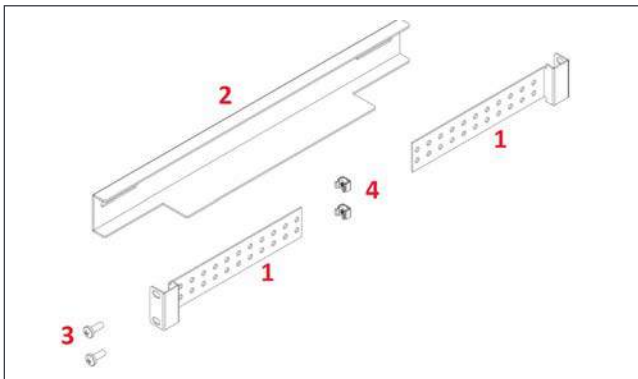

- 1** → Fixing brackets - 4 Nos
- 2** → Slider - 2 Nos
- 3** → Mounting screws - 12 Nos
- 4** → Cage nuts - 12 Nos

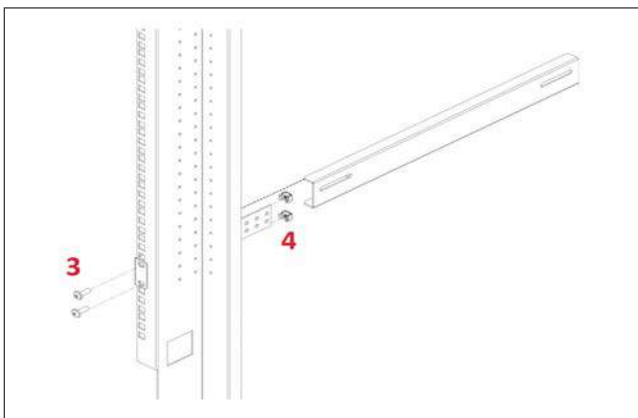

Assemble the sliders and adjust the length to suit the mounting depth.

Fix cage nuts (**4**) in the cabinet front and rear frame of the left and the right side.

Fix the left and right slider of the cabinet with the supplied screws (**3**).

## Installation of Bravo ECI Shelf

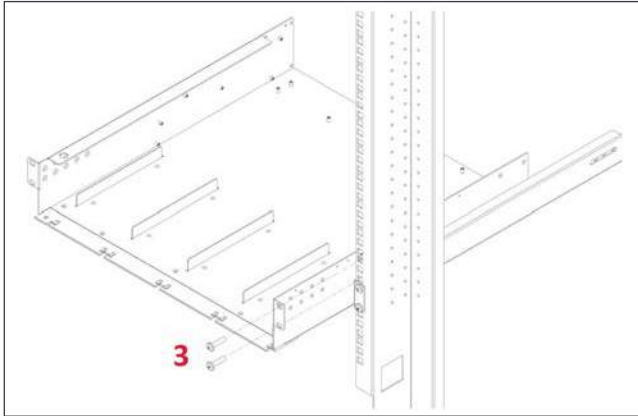

Fix cage nuts (4) in the mounting frame.

Slide the shelf in position and fix the shelf with the supplied screws (3).

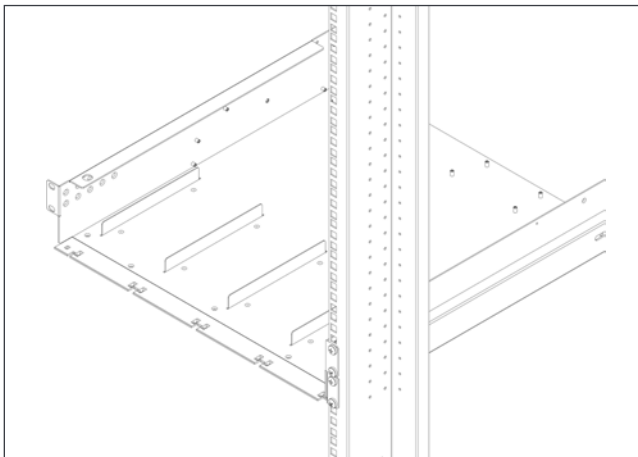

Finished.

## 9.2 Electrical installation for Bravo Shelf

### 9.2.1 Pre requisites

- The sub-rack have markings for all terminations.
- All cables shall be rated at Min 90 deg C.
- Electrical terminations shall be tightened with 5Nm.
- All connection screws are M5 x 12 mm.
- DC Input-Individual (per module), observe polarity.
- AC Input / AC output-Common (per shelf), respect phases.
- Wire all positions in the sub-rack for future expansion.
- Input AC / Output AC / Input DC / Signal cables shall be separated.
- Cable crossings shall be done in 90 deg angles.

9.2.2 Terminations

All terminations are clearly marked.

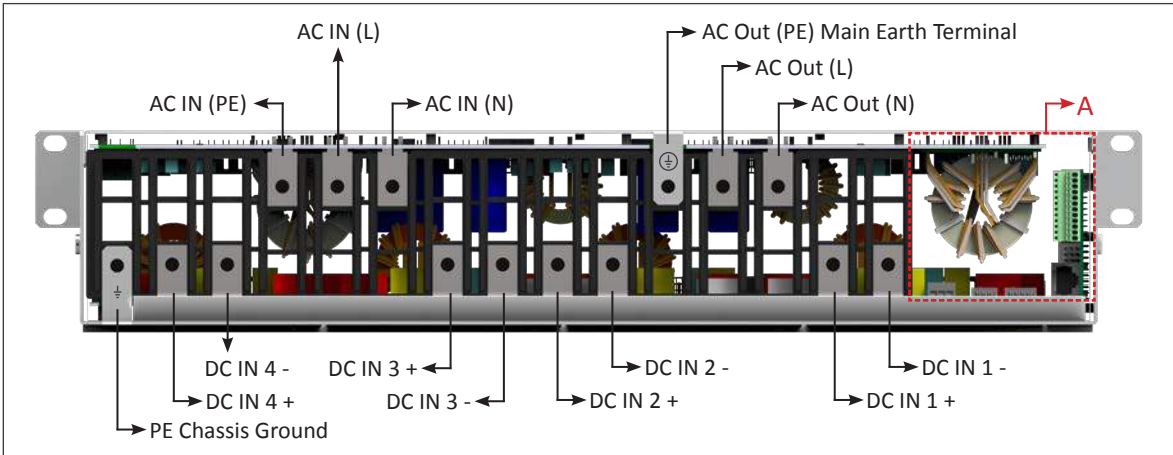

Bravo ECI 48 Vdc - Shelf Rear Details

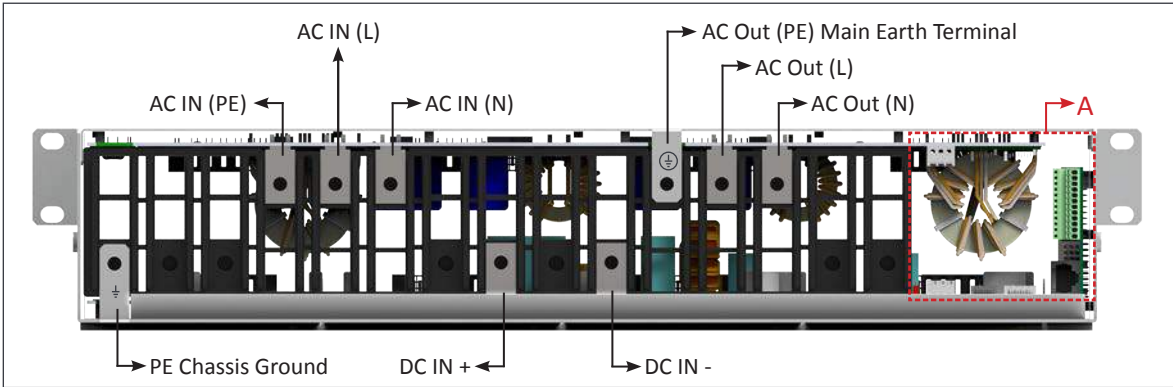

Bravo ECI 380Vdc - Shelf Rear Details

9.2.3 Grounding

“PE CHASSIS GROUND” 

PE Chassis ground shall be wired to MET or distributed earth bar connected to MET, according to local regulations.

### 9.2.4 DC Input

Model	MCB per inverter module	Cable, min	Connector	Torque
48 Vdc (For 230 Vac and 277 Vac)	63 A	2 x 16 mm <sup>2</sup>	M5	5 Nm
336 Vdc (380 V) (For 230 VAC and 277 Vac)	40 A	2 x 6 mm <sup>2</sup>		
336 Vdc (For 120 Vac)	23 A	2 x 4 mm <sup>2</sup>		

**Warning:**

It is mandatory to install 2 pole breaker or fuse on 380 Vdc input. Each pole must be capable to sustain 440 Vdc!

Note: Module operates on derated power from 260 Vdc to 200 Vdc

### 9.2.5 AC Input

**WARNING !!!**

Recommendation of IEC 60364 4. 43

**431.3 Disconnection and reconnection of the neutral conductor in multi-phase systems**

Where disconnection of the neutral conductor is required, disconnection and reconnection shall be such that the neutral conductor shall not be disconnected before the line conductors and shall be reconnected at the same time as or before the line conductors.

	Cable, min	Connector	Torque
48 Vdc and 380 Vdc	3 x 10 mm <sup>2</sup>	M5	5 Nm

Note: Icc value measured as 76.2 A<sub>rms</sub> per shelf with four modules.

### 9.2.6 AC Output

	MCB per shelf	Cable, min	Connector	Torque
48 Vdc and 380 Vdc	2P 63 A	3 x 10 mm <sup>2</sup>	M5	5 Nm

9.2.7 Signalling

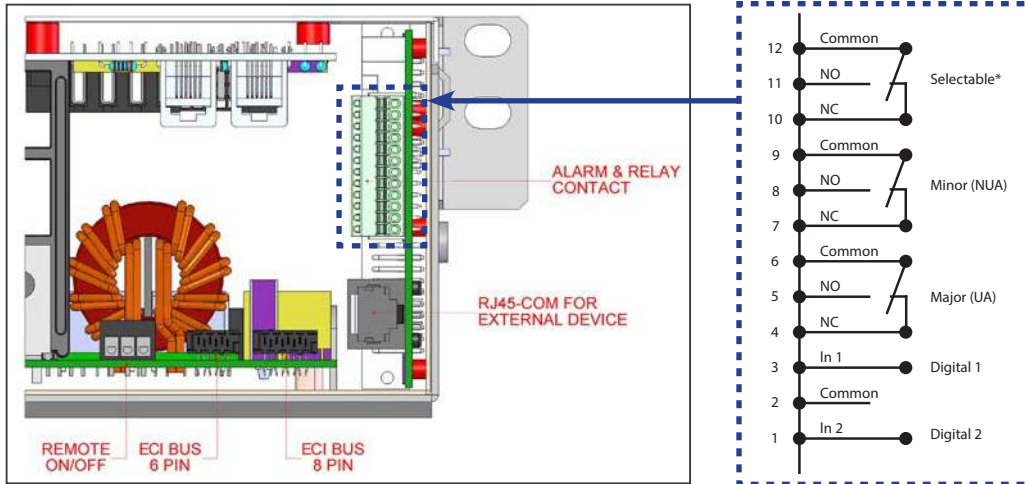

**Relay characteristics (Selectable, Major, Minor)**

- Switching power 60 W
- Rating 2 A at 30 Vdc / 1A at 60 Vdc
- Max wire size 1 mm<sup>2</sup>

**Digital input characteristics (Digital In 1 / 2)**

- Signal voltage +5 Vdc (galvanic insulated)
- Max wire size 1 mm<sup>2</sup>

### 9.2.8 Remote ON/OFF

Notice: The shelf is by default equipped with a connection between pin 3 and 2. If remote ON/OFF is not used the strap shall remain in all connected shelves. Should the remote ON/OFF be used, all straps must be removed and in one (1) shelf replaced with a changeover contact or emergency button.

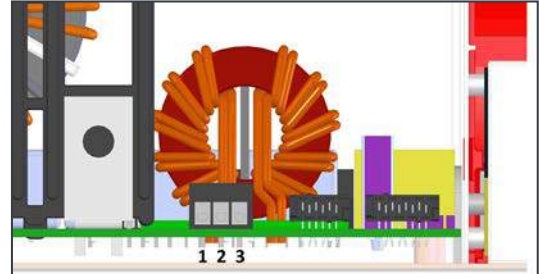

- The remote ON/OFF switch the output AC OFF.
- Input AC and input DC is not affected by the remote ON/OFF.
- The remote ON/OFF can be connected to any shelf.
- The remote ON/OFF requires changeover contacts, one input opens as the other close. If both transitions are not picked up the status is not changed.

#### Relay characteristics (Remote ON/OFF)

- Signal voltage +5 VDC (galvanic insulated)
- Max wire size 1 mm<sup>2</sup>

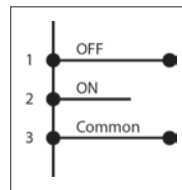

#### Functional table for remote ON/OFF function

#	Pin 1-3	Pin 2-3	Status	Indication
1	Open	Open	Normal operation	All (Green)
2	Closed	Open	OFF	AC output (OFF) AC Input (Green) DC Input (Green)
3	Open	Closed	Normal operation	All (Green)
4	Closed	Closed	Normal operation	All (Green)

#### Warning:

If remote ON/OFF is not used, pin 2 and 3 MUST be bridged together!

### 9.2.9 Internal bus (ECI Bus 6 pin / ECI Bus 8 pin)

- In A la Carte systems the internal Bus is pre installed.
- The internal bus comprise of a 6 pole ribbon cable and an 8 pole ribbon cable.
- The internal bus connectors are sensitive and special caution should be taken during installation to keep them out of harms way.
- The internal bus is connected from the first shelf to the last shelf.



### 9.2.10 Rear cover

- The rear cover provides IP 20 protection for the rear terminations when required.
- The rear cover is snapped into position in the rear of the sub-rack.
- Remove material using a pair of side-cutters to allow cable entry and exit.
- The rear cover is ordered separately.



Connect cables



Cut holes to allow cable access



Clip rear cover into place

## 10. Installation of Cabinet (A la Carte)

### 10.1 Unpacking the system

Helios cabinets are always fixed on a pallet, and then packed in a wooden crate.

These crates are usually delivered laying flat, horizontally.

To unpack your cabinet, we recommend the following method:

1. Make sure that the crate is laying flat, with the correct side up. This side is identified by a double red arrow.
2. Remove the top cover in order to be able to identify the top and bottom sides of the cabinet.
3. Raise the crate vertically with the top side of the cabinet up. Make sure that the cabinet does not fall forward out of the crate while you do so.
4. Remove the cabinet and its attached pallet from the crate.

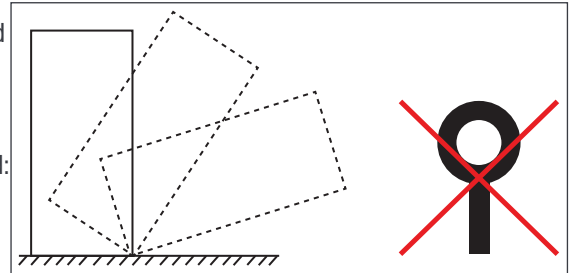

If you prefer to take the wooden crate apart before raising the cabinet, make sure you do not damage or dent the cabinet while doing so.

**Warning :** The top cover fixing bolts may NEVER be replaced with lifting eye bolts.

### 10.2 Module packing

When modules are ordered **together with a system**, they are either delivered in the cabinet or on a separate pallet.

- If you find the modules in the cabinet : you may want to remove them in order to raise the cabinet more easily, **but before you do so make sure to have identified in which slot was each module. Indeed, it is important to replace each module in the same slot** it was delivered in!
- If the modules have been delivered separately, in carton on pallet, they will be clearly identified in order to be placed in the right slot.
- It is important to place the modules in the right slot, as this will ensure that the addressing of each module in the config file corresponds to the physical slot. Without this, the system will of course function properly but you might find it difficult to identify on which modules your applying changes you would be bringing to the config file.
- Also, in 3 phase systems, replacing modules configured to function in a specific phase in a slot assigned to another phase will result in the module to be un-synchronized. Your system may not start and you will have to reconfigure manually each module that was misplaced.

If you ordered modules only:

- If they are meant to be used in running systems or in a not operational single phase system, you may insert them in any slot.
- If they are meant to be placed in a not yet started 3 Phase system, follow these steps:
  - Insert one module per phase.
  - Start the system according to the start-up and commissioning procedure.
  - Insert the remaining modules progressively.

Module packing material shall be taken apart.

### 10.3 Removing the cabinet rear protection

Wooden wedges are fixed at the back of the cabinet to prevent parts from moving and sustaining damage during transportation. These wooden wedges must be removed before going further with the cabinet's installation and commissioning

1. Remove the rear panel.
2. Identify the protection (see the following figure).
3. Cut the tie wraps holding the back wedges and remove them.

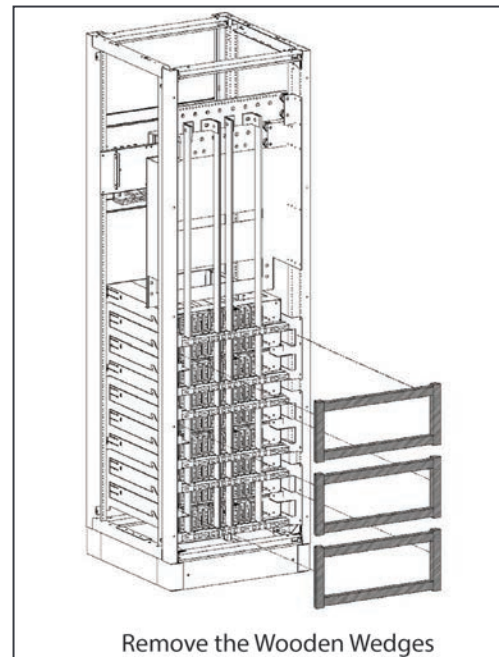
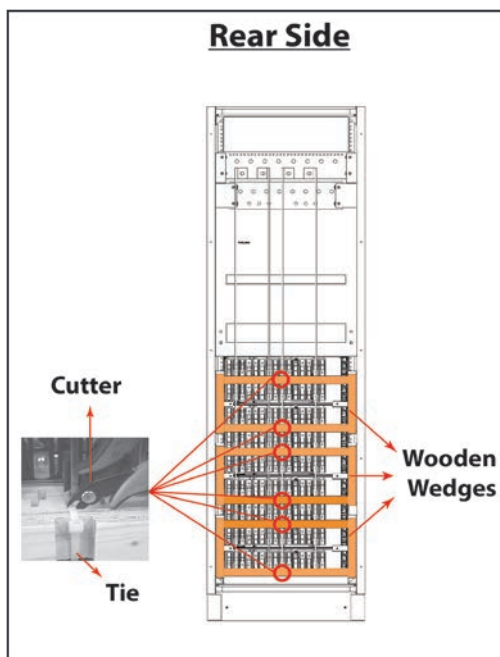

### 10.4 Electrical installation

- All cables shall be halogen free and rated min 90 deg C.
- Wire all positions for future expansion.
- Input AC / Output AC / Input DC / Signal cables shall be separated.
- Cable crossings shall be made at 90 deg angles.
- Empty inverter positions shall be blanked off.

10.4.1 Positioning

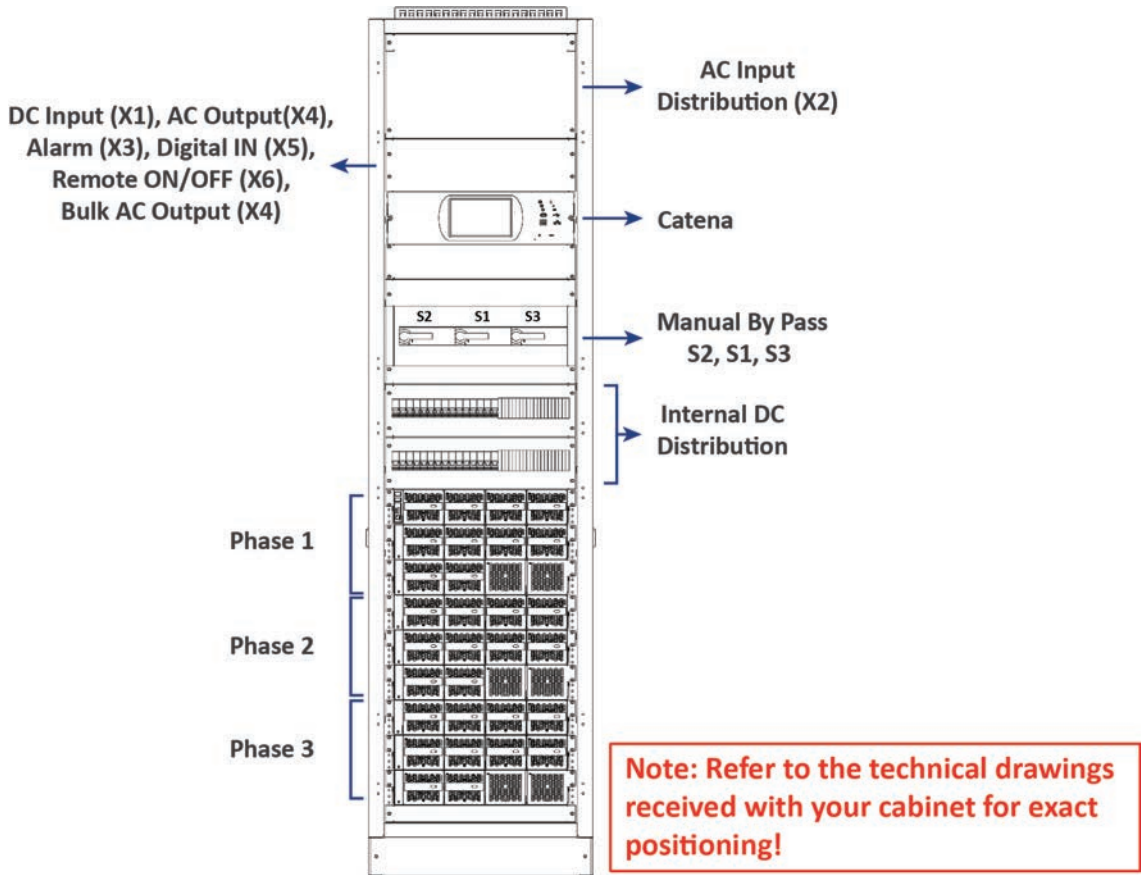

10.4.2 Cabling

Note: Do not block the airflow through the top of the cabinet. Cables are run through the top or bottom of the cabinet. The top cover can be split into two parts to facilitate cabling. The top cover accommodates nylon tie straps used to strap the cables.

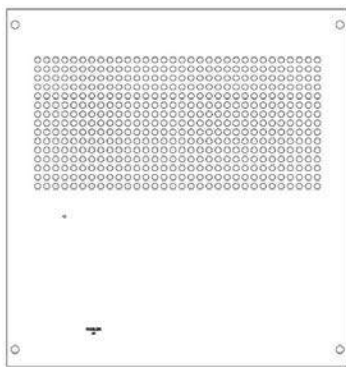

Top Plate - Type I

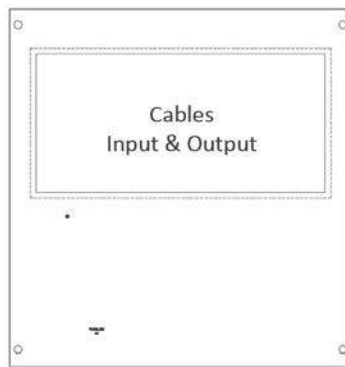

Top Plate - Type II

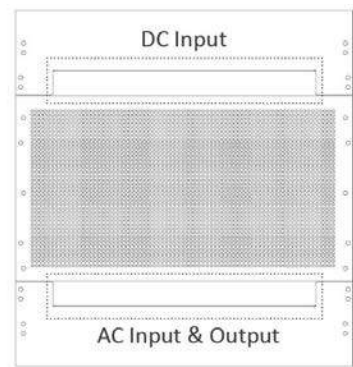

Top Plate - Type III

### 10.4.3 Grounding

Ground terminals are located in the top rear left corner, labelled "PE CHASSIS GROUND"

PE Chassis ground shall be wired to MET or distributed earth bar (MET). Ground must be terminated even if commercial mains is not available.



According to local regulations, Min 16 mm<sup>2</sup>.

### 10.4.4 Surge Suppression

The mains (AC) supply of the modular inverter system shall be fitted with suitable Lightning surge suppression and Transient voltage surge suppression for the application at hand. Manufacturer's recommendations of installation shall be adhered. It is advisory to select device with alarm relay for function failure.

Indoor sites are considered to have a working lightning surge suppression device in service.

- Indoor sites                      Min Class II.
- Outdoor sites :                  Min Class I + Class II or combined Class I+II.

### 10.4.5 AC Input (X2)

**WARNING !!!**  
 Recommendation of IEC 60364 4. 43

**431.3 Disconnection and reconnection of the neutral conductor in multi-phase systems**

Where disconnection of the neutral conductor is required, disconnection and reconnection shall be such that the neutral conductor shall not be disconnected before the line conductors and shall be reconnected at the same time as or before the line conductors.

**WARNING !!!**  
**Input Neutral is required to operate the Inverter, UPS**

In TN-S System no 4 pole input switch or circuit breaker shall be used. If you have to use 4 pole protective device, be aware that the neutral against the ground is floating. The inverter, UPS will operate without problem but you may infringe the local regulation.

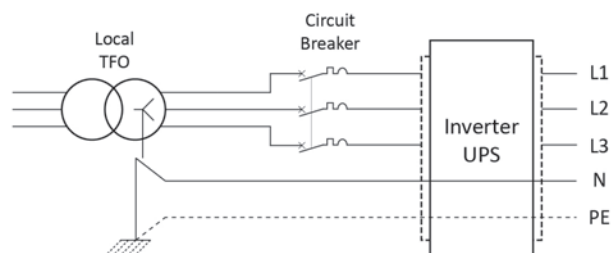

The AC input is wired to a screw terminal.

Max cable area is 180 mm<sup>2</sup>

### 10.4.5.1 Single phase

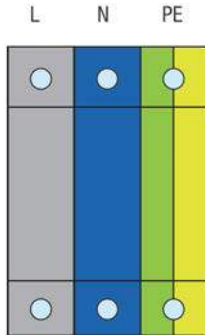

### 10.4.5.2 Three phase

**NOTE:** The three phase input is 123, ABC, RST phase sensitive; clockwise rotation is recommended. Phase one starts at 0° phase shift, while the other phases will be at -120° phase shift and + 120° phase shift resulting in three phase output.

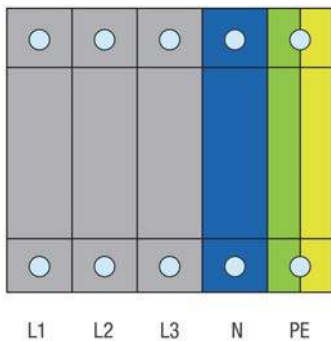

### 10.4.6 DC Input (X1)

#### 10.4.6.1 Bulk Input

- Common DC input per system.
- **Note:** Screws and nuts are not included in the delivery.
- M12 holes.
- Internal DC distribution with circuit breakers (Q01-Q32) per inverter module.
- Max 8 x 240 mm<sup>2</sup> per pole (group).

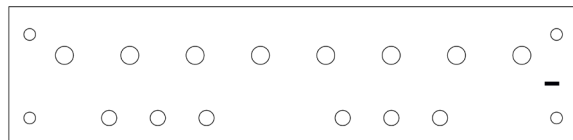
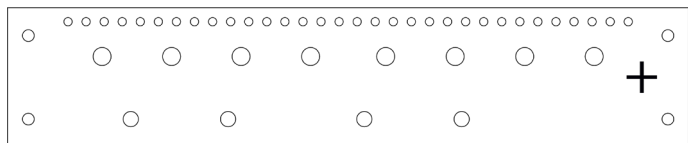

### 10.4.6.2 2 DC Input

- 2 x Common DC input per system.
- **Note:** Screws and nuts are not included in the delivery.
- M12 holes.
- Internal DC distribution with circuit breakers (Q01-Q32) per inverter module.
- Max 3 x 240 mm<sup>2</sup> per pole (group).

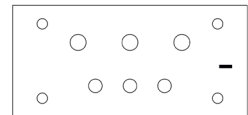
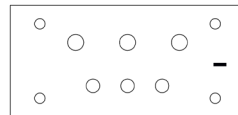
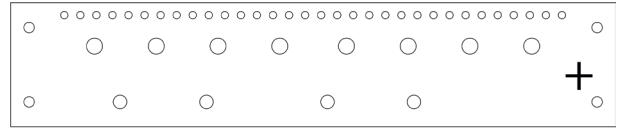

### 10.4.6.3 3 DC Input

- 3x Common DC input per system.
- **Note:** Screws and nuts are not included in the delivery.
- M12 holes.
- Internal DC distribution with circuit breakers (Q01-Q32) per inverter module.
- Max 2 x 240 mm<sup>2</sup> per pole (group).

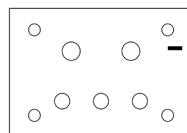
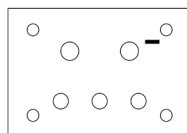
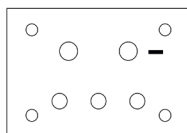
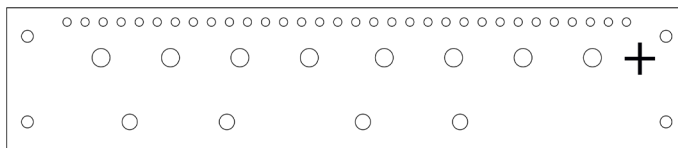

### 10.4.6.4 Individual Input

- Individual DC input per module/shelf and common return.
- **Note:** Screws and nuts are not included in the delivery.
- M6 holes for positive bus bar per connection.
- Max 35 mm<sup>2</sup> per connection terminal.

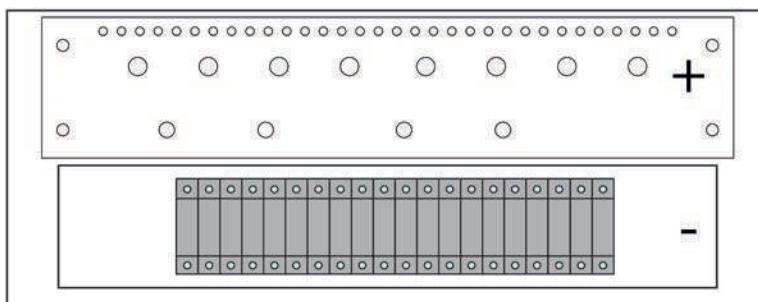

10.4.7 Connection Table – AC Input (X2) & Output (X4) for 48 Vdc and 380 Vdc version

The AC input supply breaker shall be 2p for single phase, and minimum 3p for three phase.

Power (kVA)		AC Input & Output Screw terminal		
1ph	3ph	Calculated	Fuse/CB	Min.Cable mm <sup>2</sup>
12		52.5 A	63 A	16
24		105 A	125 A	35
36		157 A	160 A	70
	36	3 x 52.5 A	3 x 63 A	3 x 16
48		210 A	250 A	95
60		262.5 A	300 A	150
72		315 A	350 A	180
	72	3 x 105 A	3 x 125 A	3 x 35
84		370 A	400 A	180
		3 x 131 A	3 x 160 A	3 x 70
96		420 A	630 A	2 x 180

10.4.8 Connection Table DC Input 48 VDC (X1)

Power (kVA)		DC Input Bulk		DC Input 2 Common		DC Input 3 Common		DC Input individual (1 Feed per Module)	
1ph	3ph	Fuse/CB	Min Cable mm <sup>2</sup>	Fuse/CB	Min Cable mm <sup>2</sup>	Fuse/CB	Min Cable mm <sup>2</sup>	Fuse/CB	Min Cable mm <sup>2</sup>
12		250 A	120					63 A	Live: Screw terminal 10 mm <sup>2</sup> Common: Cable lug. M5-5 Nm torque
24		500 A	240	250 A	120				
36		800 A	2 x 240			250 A	120		
48		1000 A	4 x 150	630 A	2 x 150				
60		1250 A	3 x 240						
72		2 X 800 A	4 x 240	800 A	2 x 240	630 A	2 x 150		
	72								
84		2 X 1000 A	8 x 150						
	90	2 X 1000 A	8 x 150			800 A	2 x 240		
96		2 X 1000 A	8 x 150	1000 A	4 x 150				



10.4.9 Connection Table DC Input - 380 VDC (X1)

**Warning:**

It is mandatory to install 2 pole breaker or fuse on 380VDC input. Each pole must be capable to sustain 440 VDC!

Power (kVA)		DC Input Bulk		
		Cable lug		
1ph	3ph	Fuse/CB	Min Cable mm <sup>2</sup>	Screw and Torque
12		40 A	10	M5 5 Nm torque
24		80 A	25	
36		125 A	70	
	36			
48		160 A	70	
60		200 A	95	
72		250 A	120	
	72			
84		300 A	150	
	90	300 A	150	
96		350 A	180	

10.4.10 Signalling

The illustration below shows the X3 relays contacts in a non-alarm state when the system is operational. In this case, the relays are energized and as below.

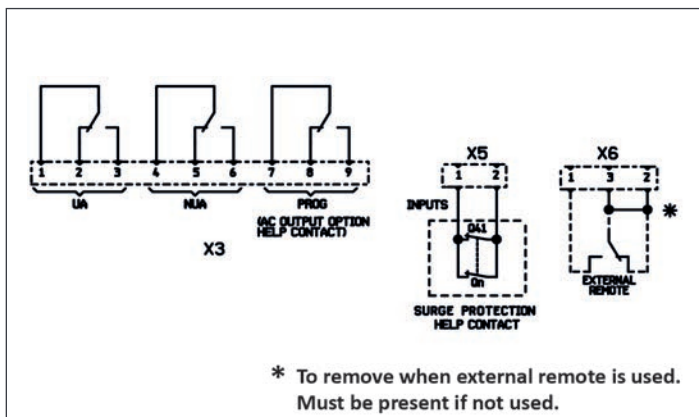

When an alarm occurs, the X3 relay contacts are de-energized and switch.

### 10.4.10.1 Alarm (X3)

Relay characteristics X3 (Major (UA), Minor (NUA), Prog)

- Switching power     60 W
- Rating                 2 A at 30 VDC / 1 A at 60 VDC
- Max wire size        1 mm<sup>2</sup>

### 10.4.10.2 Digital In (X5)

Input characteristics X5 (Digital In 1, Digital In 2)

- Signal voltage        +5 VDC (galvanically insulated)
- Max wire size        1 mm<sup>2</sup>

### 10.4.10.3 Remote ON/OFF (X6)

**Note:** The system is by default equipped with a connection between pins 3 and 2. If remote ON/OFF is not used the strap shall remain. Should the remote ON/OFF be used the strap must be replaced with a changeover contact or emergency button.

- The remote ON/OFF switches the output AC OFF.
- Input AC and input DC is not affected by the remote ON/OFF.
- The remote ON/OFF can be connected to any shelf.
- The remote ON/OFF requires changeover contacts, one input opens as the other closes. The status is not changed unless both transactions are detected.
- Digital input characteristics (Remote ON/OFF)
  - Signal voltage +5 VDC (galvanically insulated)
  - Max wire size 1 mm<sup>2</sup>

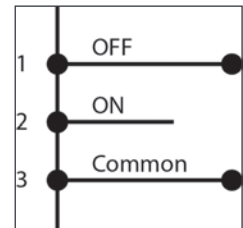

Functional table for remote ON/OFF function

#	Pin 1-3	Pin 2-3	Status	Indication
1	Open	Open	Normal operation	All (Green)
2	Closed	Open	OFF	AC output (OFF) AC Input (Green) DC Input (Green)
3	Open	Closed	Normal operation	All (Green)
4	Closed	Closed	Normal operation	All (Green)

**Warning:**

**If remote ON/OFF not used, pin 2 and 3 MUST be bridged together!**

### 10.4.10.4 Forced start

Initial system start must be performed with an operational T2S ETH. If the T2S ETH is missing at start-up the modules will fail to start.

The following sequence of the Remote ON/OFF will force the system to start without the T2S ETH.

#3 ==> #2 ==> #3 will force the modules to start.

# 11. Interface

## 11.1 Inverter module

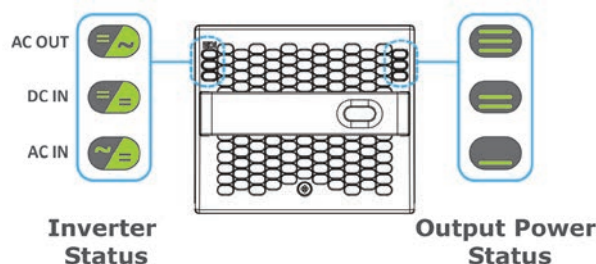

Inverter Status LED	Description	Remedial action
OFF	No input power or forced stop	Check environment
Permanent green	Operation	
Blinking green	Converter OK but working conditions are not fulfilled to operate properly	
Blinking green/orange alternatively	Recovery mode after boost (10 In short circuit condition)	
Permanent orange	Starting mode	
Blinking orange	Modules cannot start	Check T2S ETH
Blinking red	Recoverable fault	
Permanent red	Non recoverable fault	Send module back for repair

Output Power (redundancy not counted)						
<5%	5% to 40%	40 to 70%	80 to 95%	100%	100% = overload	Output Power (redundancy not counted)
×	×	×	≡	≡	≡	Status output power LED
×	×	≡	≡	≡	≡	
—	—	—	×	—	—	
1B	1P	2P	2P	3P	3B	Behavior (B = blinking – P permanent )

## 11.2 T2S ETH

- Alarm indication on T2S ETH (Urgent / Non Urgent / Configurable)
  - Green: No alarm
  - Red: Alarm
  - Flashing Exchanging information with inverters (only Configurable alarm)
- Outgoing alarm relay delay
  - Urgent 60 seconds delay
  - Non urgent 30 second delay
- Parameter setting via Laptop.
- Factory default according to list of set values, see Table of set values

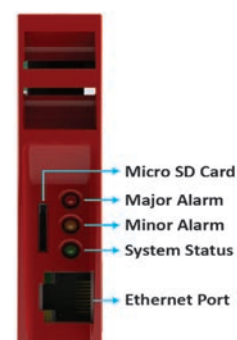

# 12. Inserting/removing/replacing - modules

## 12.1 ECI Inverter

- The ECI inverter is hot swappable.
- When a new module is inserted in a live system it automatically adapts to a working set of parameters.
- When a new module is inserted in a live system it automatically assigns the next available address.

### 12.1.1 Removal

**Notice:** When one or several inverter module is/are removed access to live parts becomes possible. Replace module(s) with blanks without delay.

1. Rotate the screw in anti clockwise by using cross head screw driver to unlock the latch.
2. Hold the front handle and pull the module out.
3. Replace with a new module or a blind unit

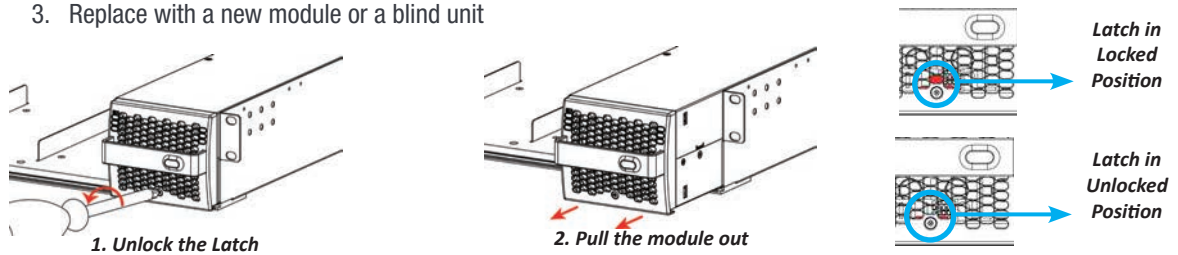

### 12.1.2 Inserting

1. Check module compatibility (DC Voltage!).
2. Place the module in the shelf and slide in.
3. Using the module handle, push firmly until the unit is properly connected.
4. Rotate the screw in clockwise by using cross head screw driver to lock the latch.
5. The module will start up and take the first address available on the bus.

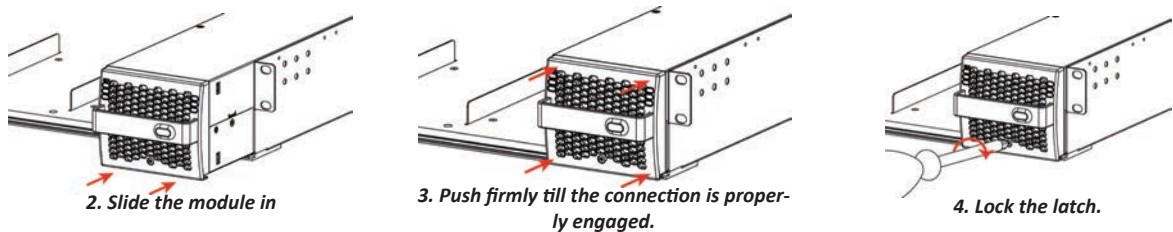

## 12.2 T2S ETH

### 12.2.1 Removal

- Use a small screw driver to release the latch keeping the T2S ETH in position.
- Pull the T2S ETH out.

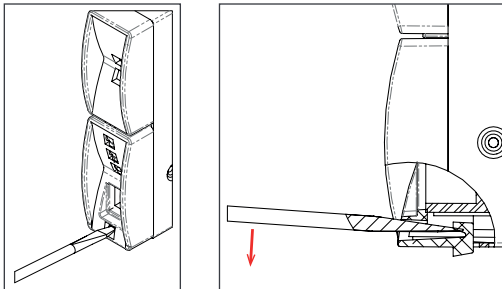

### 12.2.2 Inserting

- Push the T2S ETH firmly in place until the latch snaps into position.

## 12.3 Fan replacement

The FAN life is approximately 60,000 (Sixty Thousand) hours. The inverter modules have fan runtime meters and fan failure alarms. Fan failure can result from a failing fan or driver circuit.



1. Let the module rest at least 5 minutes before initiating work.
2. The inverter front cover must be removed. Use a screw driver and remove the screws on both side of the module.
3. Free up the fan. (Note the fan connector and wires position).
4. Disconnect the supply cord, and remove the fan..
5. Replace with new fan and connect supply cord.
6. Place the front cover and tighten the screws on both sides of the module.
7. Check fan for operation.
8. Access T2S ETH and reset the fan run time alarm from within the action menu.



## 13. AC Output Distribution

### 13.1 Miniature Circuit breaker Installation/Removal

Circuit breakers are normally factory installed.

How to add breakers:

1. Insert the short connection cable (10 mm<sup>2</sup> (included)) in the breaker Line-side and tighten.
  - Up to 40 A breaker - use one connection cable.
  - 63 A breaker - use two connection cables.
2. Clip breaker on to the DIN rail.
3. Insert insulated screw driver into the terminal to load the spring.
4. Insert connection cable and remove screw driver.
5. Connect load cable to breaker, Neutral and Ground.
6. Switch breaker ON.

Remove breaker in reverse order

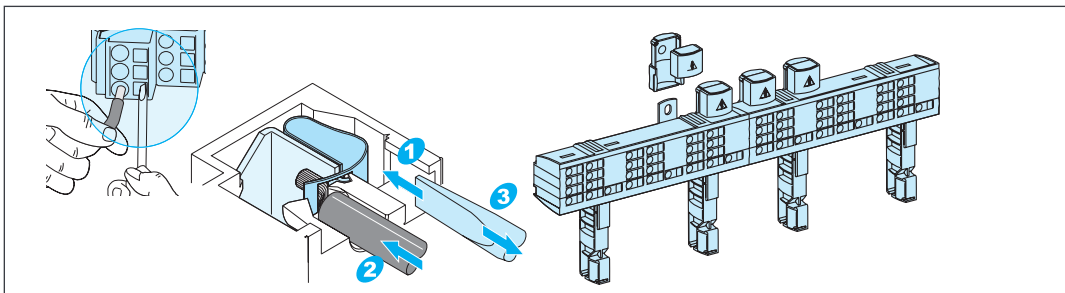

### 13.2 MCCB

MCCBs are factory installed.

A wide range of breakers is used. Delivered breakers may vary from the example shown in the picture.

1. Make sure that the breaker is in OFF position.
2. Connect load cables to the terminal.
3. Switch the breaker ON.



## 14. Manual By-Pass

Manual By-Pass has to be operated by trained people only.

When system is in manual by-pass the load is subjected to mains voltage without active filtering. Output alarm is activated when system is in manual by-pass.

The Manual By-Pass cannot be operated remotely.

The Manual By-Pass can be integrated into the Helios cabinet if requested at time of order. A Manual By-Pass purchased separately must comply with the instructions within section 14.2, page 40

### 14.1 Pre-requisites

Commercial AC power must be present, and the inverter must be synchronized with it, before operating MBP. The upstream commercial breaker must be correctly sized to accept the overload, and if the AC is supplied by a Gen-set, the minimal required power will be twice the nominal power of the inverter.

The inverter may be overloaded during the MBP procedure, depending on voltage network and output. Inverter voltage setting: To reduce the impact of an overload, the inverter power and current will be reduced from 150% to nominal value.

The by-pass switch disconnects all AC voltage on the shelves but has no effect on the DC feeding the inverter and the remote alarm terminal.

**It is requested in order to reduce the inrush current during manual by pass operation to adjust the inverter AC output voltage to the same value as AC input voltage. If the difference between AC input and AC output voltage exceed 5 Vac, there is a risk of shutdown of inverter due to high inrush current during the return to normal operation from Manual By Pass engaged.**

### 14.2 For those who integrate the MBP into their cabinet

The schematic gives a global view of single phase and 3 phase ECI inverter systems with Manual By-Pass.

1. It is mandatory to wire auxiliary contacts S1, S3 from By Pass switches to digital input 2 and remote on/off as indicated in the following schematic.

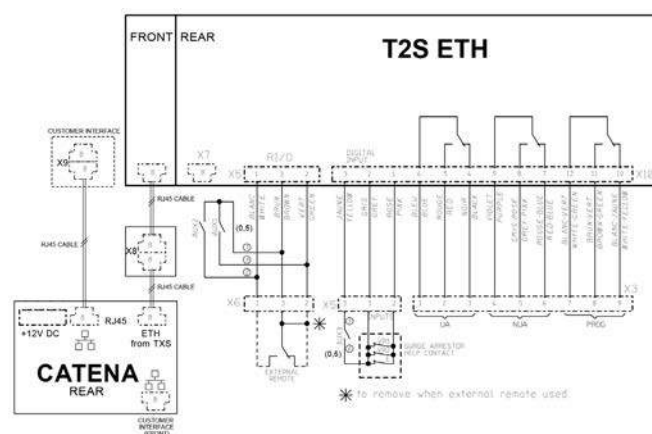

2. The MBP should be configured and wired to Dign1 when a MBP is present. T2S ETH use this input to tell the modules that MBP is engaged.



### 14.2.1 Normal to By-Pass

1. Turn switch to ON, passing through Intermediate.
2. Switch DC OFF.

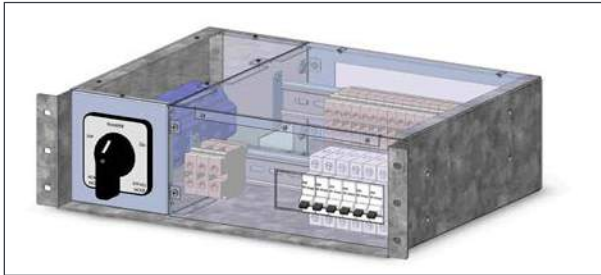

### 14.2.2 By-Pass to Normal

1. Switch DC ON.
2. Turn switch to INTERMEDIATE (mid position).
3. PAUSE: Wait until the inverter modules reach full operation and have synchronized (30-60 seconds).
4. Complete turn to OFF.

## 14.3 Helios 20 kVA Manual By-Pass and termination box

The manual by pass operates via three individual switches (S2, S1, and S3). It creates a by-pass from the mains input to the output AC distribution. Inverter modules are by-passed, allowing disconnection without impacting the load.

### 14.3.1 Normal to By-Pass

- |    |     |        |
|----|-----|--------|
| 1. | S1: | 0 to 1 |
| 2. | S2: | 1 to 0 |
| 3. | S3: | 1 to 0 |
| 4. | DC  | OFF    |

### 14.3.2 By-Pass to Normal

1. DC ON
2. S3: 0 to 1
3. PAUSE, wait until the inverter modules reach full operation (30-60 seconds)
4. S2: 0 to 1
5. S1: 1 to 0

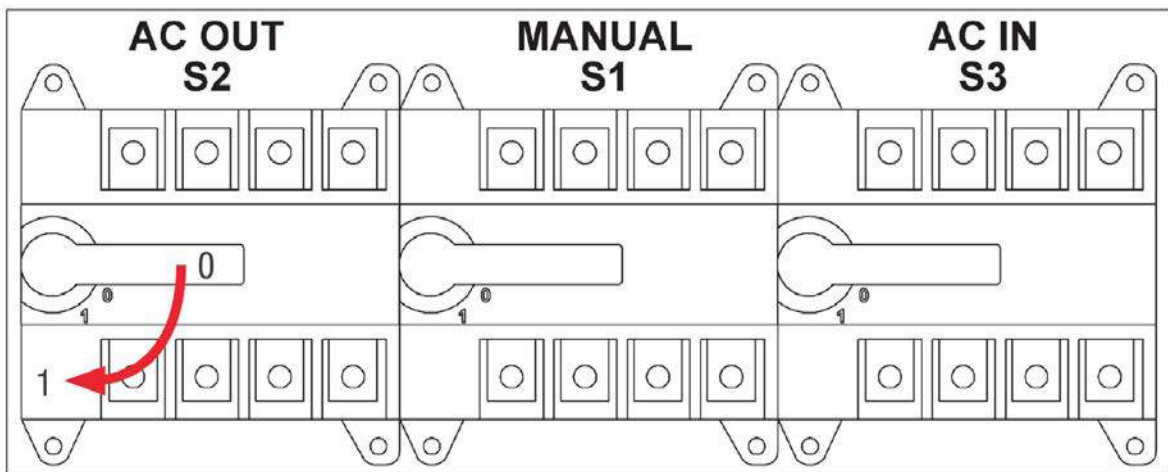

## 15. Finishing

---

- Make sure that the sub-rack/cabinet is properly fixed to the cabinet/floor
- Make sure that the sub-rack/cabinet is connected to Ground.
- Make sure that all DC and AC input breakers are switched OFF.
- Make sure that all cables are according to recommendations and local regulations.
- Make sure that all cables are strained relieved.
- Make sure that all breakers are according to recommendation and local regulations.
- Make sure that DC polarity is according to marking.
- Re tighten all electrical terminations.
- Make sure that no inverter/controller positions are left open.
- Cover empty inverter positions with blanks.
- Make sure that the Remote ON/OFF is appropriately wired according to local regulations.
- Make sure that the point of AC supply meets local regulations.

## 16. Commissioning

---

The DC breaker is a protection device. Modules are plugged in a system and DC breaker is then engaged. Please make sure the corresponding DC breaker is engaged in the ON position. Failure to observe this rules will result not to have all module operating when running on DC and have module failure when AC input recover from fault condition.

Installation and commissioning must be done and conducted by trained people fully authorized to act on installation.

It is prohibited to perform any isolation test without instruction from manufacturer.

Equipments are not covered by warranty if procedures are not respected.

## 16.1 Check list

DATA	
Date	
Performed by	
Site	
System serial number	
Module serial numbers	
T2S ETH Serial number	
ACTION	
	OK/ N.OK
Unplug all inverters except one inverter per phase (Just pull off the inverter from the shelf, to interrupt electrical contacts)	
Check the commercial AC before closing the AC input breaker.	
Switch ON the commercial AC	
Check if inverters are working (Green led)	
Check the DC power supply and switch ON the DC breakers	
Plug in all inverters one by one	
Check output voltage (on bulk output or on breaker)	
Check if inverters are working properly	
Check if system has no alarm (Disable the alarm if any)	
Read configuration file and review all parameters. Some parameters must be adapted according to the site (LVD, load on AC, AC threshold level)	
Switch OFF ACin and check if system is working on DC	
Switch ON ACin and check if system correctly transferred load on AC	
Switch OFF system and start on AC only	
Switch OFF system and start on DC only	
Check if display working properly (if this CANDIS option is present)	
Check if TCPIP working properly (if this option is present)	
Test on load (if available)	
ALARM	
Switch ON AC input and DC input and check that no alarm are present	
Pull out one inverter and check alarm according to redundancy	
Pull out two inverters and check alarm according to redundancy	
Switch OFF AC input (commercial power failure) and check the alarm according to the configuration	
Switch OFF DC input (DC power failure) and check that the alarm according to the configuration	
Check the different digital input according to the configuration (when used)	

# 17. Trouble Shooting and Defective Situations Fixing

## 17.1 Trouble Shooting

Inverter module does not power up:	Check AC input present and in range (AC breakers) Check DC input present and in range (DC breakers) Check that the inverter is properly inserted Remove inverter to verify that slot is not damaged, check connectors Check that module(s) is (are) in OFF state Check for loose terminations
Inverter system does not start:	Check that T2S ETH is present and properly inserted Check remote ON/OFF terminal Check the configuration and setting Check threshold level
Inverter only run on AC or DC:	Check AC input present and in range (AC breakers) Check DC input present and in range (DC breakers) Check the configuration and setting Check threshold level(s)
No output power:	Check output breaker
All OK but I have alarm:	Check configuration file and correct No of modules Download/clear log file
No output alarm:	Mind the default time delay (UA: 60s, NUA: 30s) Check configuration file

# 18.Maintenance

---

Maintenance shall only be performed by properly trained people.

## 18.1 Access T2S with Laptop

- Download system LOG FILE and save
  - Analyze log file and correct errors
- Download system CONFIGURATION FILE and save
  - Check/correct configuration file according to operation conditions
  - Check/correct alarm configuration
- Check module internal temperature for deviation between modules
  - Temperature deviation may indicate build up of dust. Clean with compressed air
- Check module/system load
- Check/Correct inverter mapping (DC group/AC group/ Address)
- Change configuration file to validate that system operates on both supply sources
- Check outgoing alarm, consult configuration file what actions will generate alarm

## 18.2 Manual check

- Validate input voltage (AC input, DC input, AC output) with multi-meter
- Replace dust filter
- Take a snap shot of the cabinet

## 18.3 Optional

- With an infrared camera check termination hot spots
  - Tighten terminations

## 18.4 Manual By-Pass

- If mains failure during operation the load is lost
- Perform a manual by-pass operation

## 19. Defective modules

---

- A repair request should follow the regular logistics chain:  
End-user => Distributor => Factory
- The RMA number should be mentioned on all shipping documents related to the repair.
- Be aware that products shipped back to Factory without being registered first will not be treated with high priority!(Label shown here is only for representation)

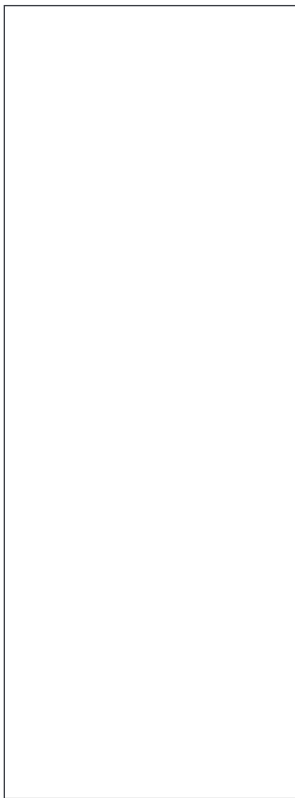



# 20. Appendix

## 20.1 Mains connection, Single phase

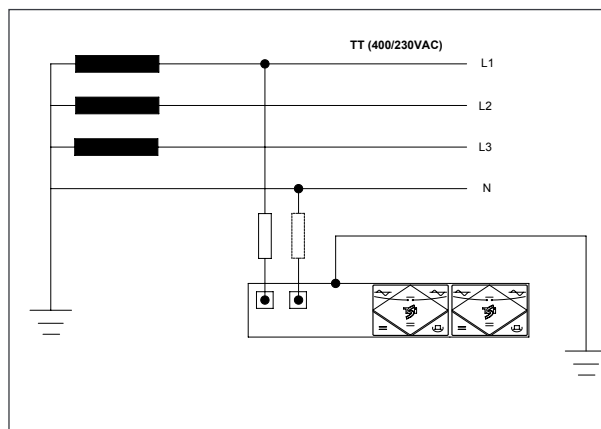
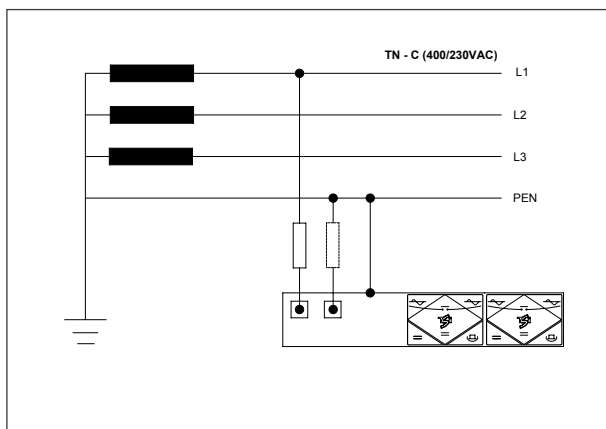
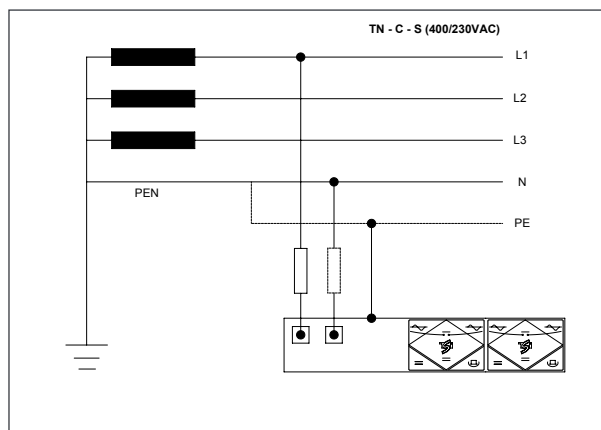
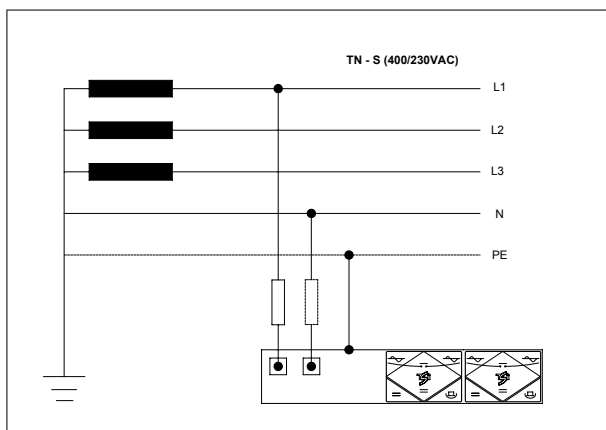

## 20.2 Mains connection, Three phases

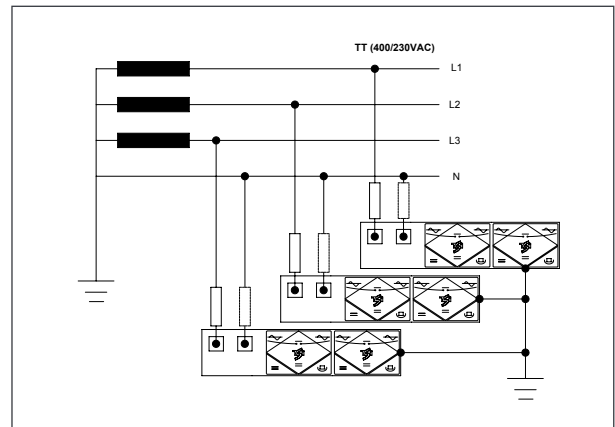
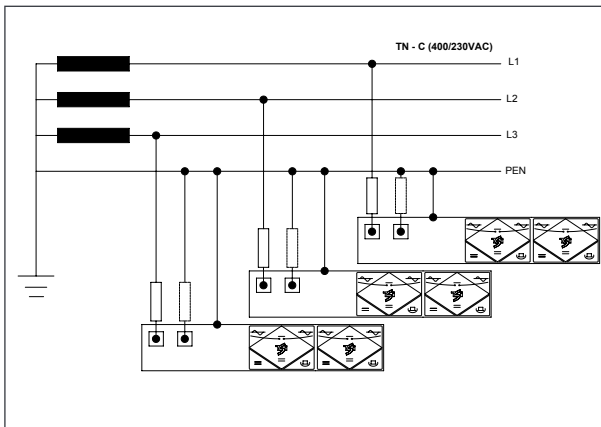
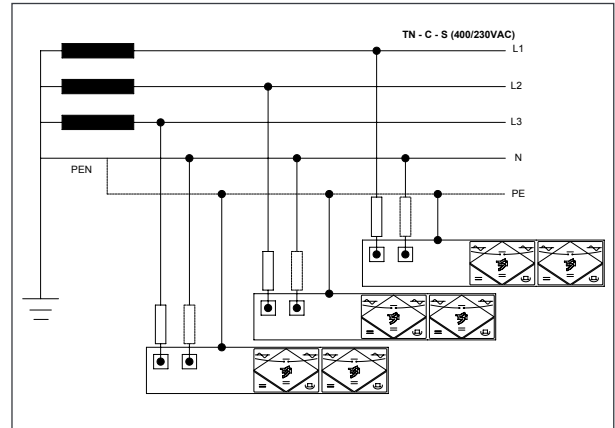
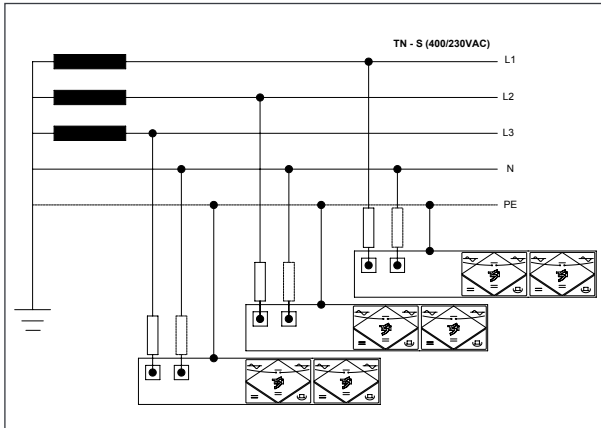

### 20.3 System default T2S ETH relay mapping

Relays Mapping				
	Major	Minor	R3	
MBP Engaged				(not set)
Surge Arrester				(not set)
Redundancy Lost	X			
Redundancy +1 Lost	X			
Main Source Lost				(not set)
Secondary Source Lost				(not set)
AC source Lost				(not set)
DC Source Lost	X			
AC Source Not Sync				(not set)
DC Source Low	X			
Output Saturated		X		
Output Overload	X			
Output Failure	X			
System Manual Off	X			
Missing Module		X		
Module Manual Off	X			
Module Output Fault		X		
Module Brownout Derating				(not set)
Module Temperature Derating				(not set)
Module Over Temperature				(not set)
Dig Input 1				(not set)
Dig Input 2				(not set)
Log Nearly Full		X		
Log Full		X		

## 20.4 Parameters setting

List of parameter with MIN, MAX and default value for 48 Vdc only. Units are 0,1V(dV), 0,01Hz (cHz) for voltage and frequency

Name	Index	Max	Default	Unit
VDC_LOW_START_1_dV	0	620	440	dV
VDC_LOW_START_2_dV	1	620	440	dV
VDC_LOW_TRANSFER_1_dV	8	620	390	dV
VDC_LOW_TRANSFER_2_dV	9	620	390	dV
VDC_LOW_STOP_1_dV	16	620	390	dV
VDC_LOW_STOP_2_dV	17	620	390	dV
VDC_HIGH_START_1_dV	24	620	580	dV
VDC_HIGH_START_2_dV	25	620	580	dV
VDC_HIGH_TRANSFER_1_dV	32	620	610	dV
VDC_HIGH_TRANSFER_2_dV	33	620	610	dV
VDC_HIGH_STOP_1_dV	40	620	610	dV
VDC_HIGH_STOP_2_dV	41	620	610	dV
VAC_LOW_START_1_dV	48	2685	1915	dV
VAC_LOW_START_2_dV	49	2685	1915	dV
VAC_LOW_START_3_dV	50	2685	1915	dV
VAC_LOW_START_4_dV	51	2685	1915	dV
VAC_LOW_TRANSFER_1_dV	52	2685	1815	dV
VAC_LOW_TRANSFER_2_dV	53	2685	1815	dV
VAC_LOW_TRANSFER_3_dV	54	2685	1815	dV
VAC_LOW_TRANSFER_4_dV	55	2685	1815	dV
VAC_LOW_STOP_1_dV	56	2685	1815	dV
VAC_LOW_STOP_2_dV	57	2685	1815	dV
VAC_LOW_STOP_3_dV	58	2685	1815	dV
VAC_LOW_STOP_4_dV	59	2685	1815	dV
VAC_HIGH_START_1_dV	60	2685	2585	dV
VAC_HIGH_START_2_dV	61	2685	2585	dV
VAC_HIGH_START_3_dV	62	2685	2585	dV
VAC_HIGH_START_4_dV	63	2685	2585	dV
VAC_HIGH_TRANSFER_1_dV	64	2685	2685	dV
VAC_HIGH_TRANSFER_2_dV	65	2685	2685	dV
VAC_HIGH_TRANSFER_3_dV	66	2685	2685	dV
VAC_HIGH_TRANSFER_4_dV	67	2685	2685	dV
VAC_HIGH_STOP_1_dV	68	2685	2685	dV
VAC_HIGH_STOP_2_dV	69	2685	2685	dV
VAC_HIGH_STOP_3_dV	70	2685	2685	dV
VAC_HIGH_STOP_4_dV	71	2685	2685	dV
FREQ_AC_LOW_START_cHz	72	6300	4730	cHz

FREQ_AC_LOW_STOP_cHz	73	6300	4700	cHz
name	index	max	default	unit
FREQ_AC_HIGH_START_cHz	74	6300	5270	cHz
FREQ_AC_HIGH_STOP_cHz	75	6300	5300	cHz
FREQ_OUT_NOMINAL_cHz	76	6300	5000	cHz
PHASE_OUT_NUMBER_1	77	8	1	/
PHASE_SHIFT_OUT_1_deg	78	360	0	degrees
PHASE_SHIFT_OUT_2_deg	79	360	120	degrees
PHASE_SHIFT_OUT_3_deg	80	360	240	degrees
VOUT_CONS_1_dV	86	2400	2300	dV
VOUT_CONS_2_dV	87	2400	2300	dV
VOUT_CONS_3_dV	88	2400	2300	dV
Short Circuit Voltage Threshold (V)	94	200	80	V
Short Circuit Hold Time (s)	95	6000	600	ds
Source Power Ratio DC vs AC	96	100	100	%
SYNCHRONISATION_TRACKING_SPEED_1	97	2	0	/
MAX_OUT_CURRENT_DERATING_pc	98	150	150	%
MAX_OUT_POWER_DERATING_pc	99	150	150	%
MAX_OVERLOAD_DURATION_s	100	15	15	s
FORCE_AC_SAFE_MODE_1	101	1	0	/
Booster 10 x In	102	1	1	/
REMOTE_OFF_DISABLE_AC_IN_POWER_1	103	0	0	/
AC in grid feed disable	104	1	1	/
If lost External Clock	105	2	0	/
Walk In Mode Time (x10 s.)	106	60	0	/
DELTA Mode	107	0	0	/
EXTRA_OVERLOAD_MODE_1	108	0	0	/
START_WITHOUT_SUPERVISION_ALLOWED_1	109	1	1	/
MAX_DC_POWER_W	110	0	0	W
DISABLE_POWER_MODE_AC_1_1	111	1	0	/
DISABLE_POWER_MODE_AC_2_1	112	1	0	/
DISABLE_POWER_MODE_AC_3_1	113	1	0	/
DISABLE_POWER_MODE_AC_4_1	114	1	0	/
Synchronizator enable	117	1	1	/
number of Synchronizator	118	32	2	/
address on XY Bus	119	32	1	/
Phase of this sub sub system	120	7	1	/
Group of this sub system	121	7	1	/
number of line in system	122	32	1	/

supply X mode	123	3	3	/
supply Y mode	124	3	3	/
DC synchronized by TUS	125	7	0	/

Name	Index	Min	Max	Default	Unit
Number of AcIn	637	0	2	1	
Nb of module AC 1	526	0	32	30	
Nb of module AC 2	527	0	32	0	
Nb of Module AC 3	528	0	32	0	
Redundancy AC 1	529			2	
Redundancy AC 2	530			0	
Redundancy AC 3	531			0	
AC in present	547	0	1	0	
Nb of AC in	637	0	2	0	
Number of AcIn	637	0	2	1	
Saturation Threshold	592	0	100	90	

