

# ADC5823

60W 48Vdc 1.25A DIN Rail PSU / Battery Charger

Page 1 of 4



In Stock Fast Quotes  
 Rapid Dispatch

[heliosps.com/priority](https://heliosps.com/priority)

## Features

- Input voltage 230/115Vac
- Output voltage 48Vdc
- Statistical MTBF >3,000,000 hours
- Built in output series diode
- Temperature compensated battery charging
- Wide output adjustment range
- Efficiency 90%
- Operating temperature -40°C - +70°C (see derating)
- EMC EN55022B (telecom)



## ADC5823 Specifications

Input Voltage	Output Voltage	Output Voltage Range	Output Current	Output Power
230/115Vac <i>selectable</i>	48Vdc	45-58Vdc	1.25A ( <i>max</i> )	60W

## ADC5000 Series Multi-Purpose Application Examples

**(A)**  
Battery backup systems  
Temperature compensated charging  
Low voltage disconnecting unit

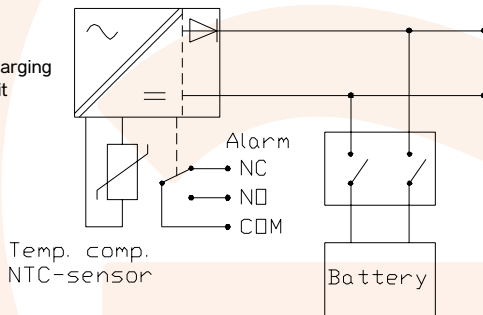

**(C)**  
Redundant n+1 system  
with built-in series diode and module fail

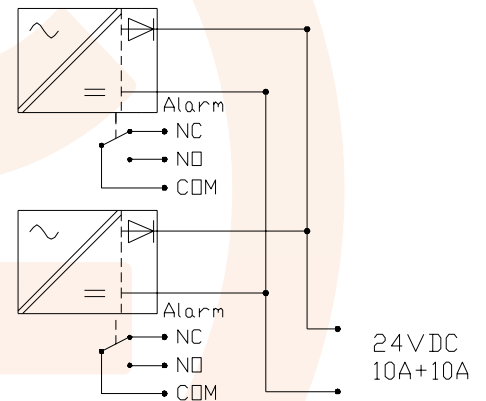

**(B)**  
Special features with external control  
- Boost charging  
- Battery test possibility  
- Shutdown by external 4-15Vdc  
- Controllable output voltage

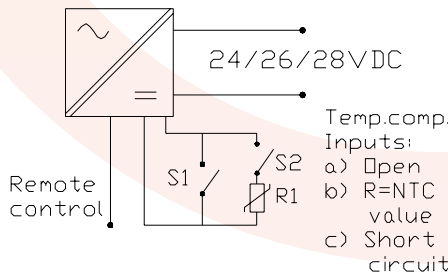

**(D)**  
Series connection (outputs)

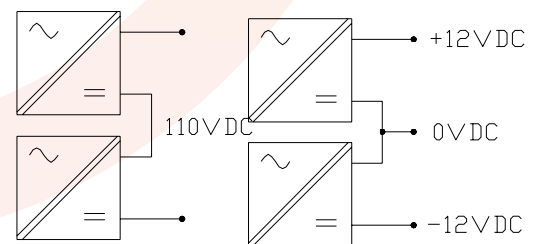

# ADC5823

## 60W 48Vdc 1.25A DIN Rail PSU / Battery Charger

Page 2 of 4

**Enedo**

**HELIOS**  
PRIORITY



In Stock



Fast Quotes



Rapid Dispatch

[heliosps.com/priority](https://heliosps.com/priority)

### ADC5823 Full Specifications

Input	
Input Voltage	230Vac / 115Vac Selectable 85-200Vdc (not UL62368-1 approved)
Input Current at 100% Load	2.5A (230Vac) / 4.5A (115Vac)
Input Frequency	45-65Hz
Efficiency	90% (typical 230Vac @ 100% Load)
Isolation	Input/Ground: 1500Vac RMS 50Hz 1min Input/Output: 3000Vac RMS 50Hz 1min Output/Ground: 500Vdc
Inrush Current	<35A <5ms (230Vac 25°C) <17A <5ms (115Vac 25°C)
Input Fuse	T6.3A High Breaking
Overvoltage Transient Protection	VDR 300VAC 77J
Output	
Output Voltage	48Vdc
Output Adjustment	45-58Vdc
Ripple Voltage	<15mV <sub>rms</sub>
Load Regulation	<0.5% (without series diode)
Line Regulation	<0.15% U <sub>inmin</sub> - U <sub>inmax</sub>
Temperature Coefficient	<0.02% / °C
Current Limit	<2A (refer current limiting curve)
Short Circuit Current	<8A (refer current limiting curve)
Hold-up time	>50ms (230Vac / 100% load)
Alarms and Indications	
Output OK	Green LED
Power Fail Relay Alarm	24VDC/0.3A / 30Vac/0.5A NO/NC relay contacts. Activated at AC fail and module fail cases. Galvanic reinforced isolation from the mains hazardous voltage required!
Under Voltage Alarm Threshold	41V ±2V
Output Overvoltage Protection	61V
Optional Shutdown	External voltage 4-15Vdc to RC pin
Optional Battery Test Control	Float charge voltage can be reduced by external 4-15Vdc control to allow battery test by using external measurement circuit
Temperature Compensation	External 2.2kΩ NTC resistor included. No external voltage allowed!
Environmental	
Storage Temperature	-40°C - +85°C
Operating Temperature	-40°C - +70°C (derating from 55°C, see curve). Maximum pollution degree 2 allowed.
Cooling	Natural convection
Humidity	85% RH Do not energise while condensation present.
Shock and Vibration	ETS 300 019-2-4 class 4M5 Vibration sin IEC60068-2-6, 2gn, 9-200m/s <sup>2</sup> Vibration broad-band random, IEC60068-2-64

Mechanical	
Dimensions	51(W) x 121(H) x 8(D)mm
Weight	360g
Enclosure	Steel / aluminium enclosure IP20
Connectors	Removable 2.5mm <sup>2</sup> screw terminals
Standards & Approvals	
Safety Standards	IEC62368-1:2018 National Difference: EU Group Differences, CA, US
EMC Emissions EN61000-6-3	EN 55022 Class B Conducted and Radiated Emissions EN61000-3-3 Flickering
EMC Immunity EN61000-6-2	EN 61000-4-2 Electrostatic Discharge EN 61000-4-3 Radiated Immunity EN 61000-4-4 Fast Transients EN 61000-4-5 Surge EN 61000-4-6 Conducted Immunity EN 61000-4-8 Power Frequency Magnetic Field Immunity EN61000-4-11 Voltage Dips and Inturreptions Immunity
Approvals	CE-marking, CE certificate IEC 62368-1:2018

### Current Limiting Curve

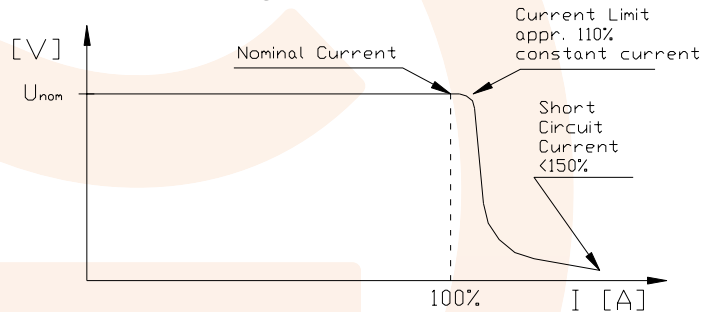

### Power Derating Curve

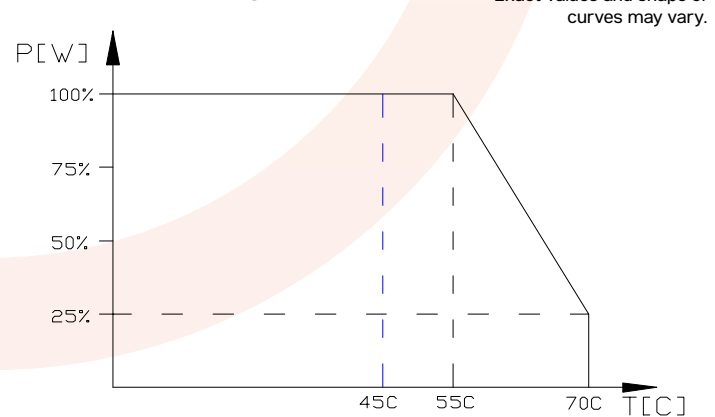

**HELIOS**  
POWER SOLUTIONS

[heliosps.com](https://heliosps.com)

Specifications subject to change.  
Last Revision: 16 October 2024

**Australia**  
[sales-au@heliosps.com](mailto:sales-au@heliosps.com)  
+61 2 7200 9200

**Asia**  
[sales@heliosps.asia](mailto:sales@heliosps.asia)  
+65 6871 4140

**New Zealand**  
[sales-nz@heliosps.com](mailto:sales-nz@heliosps.com)  
+64 9 835 0700

**Middle East**  
[sales@heliosps.asia](mailto:sales@heliosps.asia)  
+971 4 401 8484

# ADC5823

60W 48Vdc 1.25A DIN Rail PSU / Battery Charger

Page 3 of 4



In Stock



Fast Quotes



Rapid Dispatch

[heliosps.com/priority](http://heliosps.com/priority)

## Dimensions

51(W) x 121(H) x 81(D)mm

Free Installation Choice

Due to movable DIN rail connectors, ADC5823 can be flexibly installed to the available space.

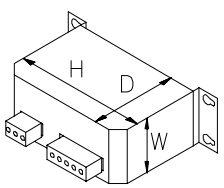

Mounting Option 1

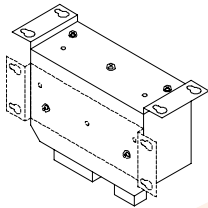

Mounting Option 2

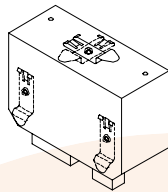

Mounting Option 3

## Temperature Compensation Effect to Float Charge Voltage

Temperature Compensation Curve ADC5000 series 48VDC models

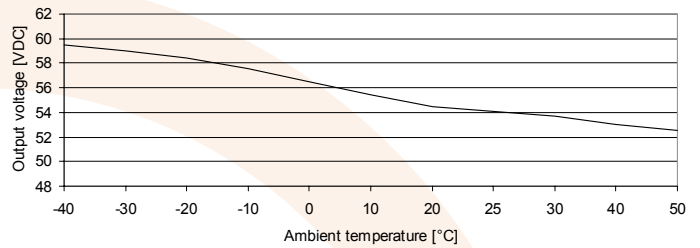

## Pin Configuration

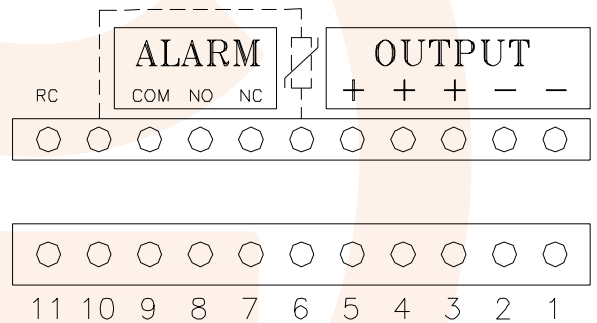
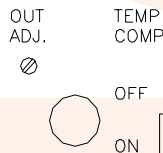
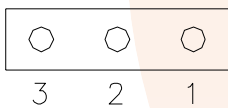
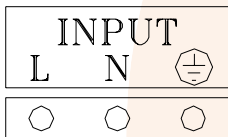

## Input Connector

1	Protective Earth
2	N
3	L

- Galvanic reinforced isolation from the mains hazardous voltage required!
- Use 60/75 or 75°C copper (CU) wire only.
- The recommended terminal tightening torque is 0.5Nm.
- Relay contact rating: 24VDC/0.3A / 30VAC/0.5A

## Output Connector

1,2	Output - (Note: Rated current 12A / pin)
3,4,5	Output + (Note: Rated current 12A / pin)
6	Temperature compensation NTC sensor (no external voltage allowed)
7	Alarm relay Normally Open (relay not energised)
8	Alarm relay Normally Closed (relay not energised)
9	Alarm relay Common
10	Temperature compensation NTC sensor (no external voltage allowed)
11	4-50Vdc control to allow battery test



In Stock



Fast Quotes



Rapid Dispatch

[heliosps.com/priority](https://heliosps.com/priority)

## Instructions

### INTENDED USE

The power supply shall only be installed and put into operation by qualified and skilled personnel and place where only skilled person access. This power supply is designed for building purposes in an enclosure and is intended to be used in industrial and telecom applications. Units can be used as a power supply or for float charging batteries in standby battery back-up solutions. For safety reasons external max 40A fuse or circuit breaker must be installed between the rectifier and battery.

R-version units also fulfill demanding environmental requirements like shocks, vibration, humidity and wide ambient temperature range. 250W units without P in the end of type number do not comply with EN61000-3-2 harmonics standard. These units are intended to be used in non-public networks only.

### SAFETY PRECAUTIONS

Do not use the unit without proper earth connection (Protective Earth). Turn power off from AC input wires before working with the power supply. Units are intended to be used as permanently connected equipment (excluding bench models with fixed power cord). Readily accessible disconnection device circuit breaker max 20A or fuse shall be incorporated in building installation wiring. If unit is used for charging batteries, external max 40A fuse or circuit breaker must be installed between the rectifier and battery.

### WARNING!

Dangerous voltages, capable of causing death, are present in this equipment. Do not remove the cover. No operator serviceable parts inside. Refer servicing to qualified service personnel.

### 115/230V INPUT VOLTAGE SELECTION

#### 125/250W models:

The unit is factory set to operate with a 230V nominal input voltage. The nominal input voltage can be selected via the internal 115/230 voltage selector on the PCB. Access to the selector is through the ventilation holes of the unit cover. **Always disconnect power before selecting.**

#### 60W models:

The unit is wide input type and will work without modification from 90VAC to 264VAC.

### USING UNIT WITH DC INPUT

60W units can be operated also by DC input voltage. See voltage range from specification and connection from pin configuration. Note! DC input is not UL62368-1 approved.

### OUTPUT VOLTAGE ADJUSTMENT AND BATTERY CHARGING APPLICATIONS

The output voltage of the module can be adjusted with the multi-turn potentiometer located on the front panel. All models can be used either as a power supply or a standby battery charger by correct adjustment. Please note that the output of the unit is not reverse voltage protected and wrong battery polarity will break the unit. So pay attention to the correct polarity.

Note! For safety reasons external max 40A fuse or circuit breaker must be installed between the rectifier and battery.

#### 125W and 250W models:

Maximum output current is available within the full voltage adjustment range.

#### 60W models:

Maximum output power is available within the full voltage adjustment range

### ALARM RELAY

The potential free alarm output indicates if the output of the unit is healthy. Alarm relay contacts, both normally open and normally closed, are presented on the unit connector. If the output is healthy, the NO and COM pins are short circuited. If the unit fails the relay contacts will changeover and NC and COM pins will be short circuited. Word "normal" in relay pins means that mode when relay is not energized.

### SERIES / PARALLEL CONNECTION

Reserve 2cm space on both sides for proper cooling. Parallel operation: Passive load sharing. Do not chain the outputs, rated current 12A / pin. Recommended cable size: 2.5mm<sup>2</sup>, length > 0.5m for optimum load sharing. External series diodes are needed for parallel connection of 60W models (FET type built in "series diode circuit" does not work properly in parallel connection). 125/250W models can be connected in parallel with or without series diodes. Redundant n+1 system can be made only with series diodes.

Series operation: Up to 500V total voltage.

### TEMPERATURE COMPENSATION

Temperature compensated charging provides the optimum float charge voltage when batteries are being used. To utilize this feature it is necessary to install a NTC sensor across the temperature compensation pins on the output connector. It is also necessary to set the jumper on the front panel to ON position. The output voltage should be adjusted when the jumper is in the OFF position. This will simulate room temperature and ensure accuracy.

The recommended sensor type is a 2.2k ohm NTC resistor, e.g. Epcos B57164-K222-K. The sensor should be installed local to the batteries. The sensor is galvanically connected to the + output. Temperature compensation sensor is included in rectifier models (x = 7, 8 or 9) delivery.

### LED

A green LED indicates that the output of the module is healthy.

### OUTPUT OVERCURRENT PROTECTION

Automatic, self-resetting electronic current limiting is included and the output is short circuit proof.

### OUTPUT OVER VOLTAGE PROTECTION (OPTION)

Output of the unit will shut down if the output voltage rises above protection level. (16Volts/12V models, 31Volts/24V models and 58 Volts/48V models). Protection must be manually resetted by disconnecting the AC mains voltage.

### OUTPUT VOLTAGE REMOTE SHUT DOWN AND BATTERY TEST OPTIONAL MODELS

Output of the unit will shut down, when a +4-15VDC signal is applied to the remote control input (RC) with reference to negative output.

In battery test models output voltage drops 15-25% when a +4-15VDC signal is applied to the RC pins as above.

The output voltage will return to the original level, when +4-15VDC signal is removed from RC pins.

### INTERNAL OUTPUT SERIES DIODE OPTION (125/250W series diode, 60W FET circuit)

The internal diode is placed in series with the positive output. The benefits of having the diode fitted are:

- Improved redundancy if the modules are connected in parallel (not for 60W models, external series diode needed)
- Power OK signal and LED work independently regardless battery or parallel connections
- The parallel connected modules can be Hot Plug replaced without the system output power interruption (60W models need external series diode)
- The reverse current bleed is low if a battery is connected to the output of the rectifier

The disadvantages of having the diode fitted are lower efficiency, deration to the output voltage regulation and load sharing. **Note: The output series diode does not protect against reverse polarity connection of the battery.**